

Contents

A-Z

Owner's Manual for
Vehicle



The Ultimate Driving
Machine



THE BMW M6 CONVERTIBLE. OWNER'S MANUAL.

BMW M. 

M6 Gran Coupe **Owner's Manual for Vehicle**

Thank you for choosing a BMW M6.

The more familiar you are with your vehicle, the better control you will have on the road. We therefore strongly suggest:

Read this Owner's Manual before starting off in your new BMW M6. Also use the Integrated Owner's Manual in your vehicle. It contains important information on vehicle operation that will help you make full use of the technical features available in your BMW M6. The manual also contains information designed to enhance operating reliability and road safety, and to contribute to maintaining the value of your BMW M6.

Any updates made after the editorial deadline for the printed or Integrated Owner's Manual are located in the appendix of the printed quick reference for the vehicle.

Supplementary information can be found in the additional brochures in the onboard literature.

We wish you a safe and enjoyable drive.

BMW AG

© 2013 Bayerische Motoren Werke
Aktiengesellschaft
Munich, Germany
Reprinting, including excerpts, only with the written
consent of BMW AG, Munich.
US English XI/13, 13 07 490
Printed on environmentally friendly paper, bleached
without chlorine, suitable for recycling.

ADDENDUM TO BMW M6 CONVERTIBLE OWNER'S MANUAL 1402926037

We wanted to provide you with some updates and clarifications with respect to the printed BMW Owner's Manual. These updates and clarifications will supersede the materials contained in that document.

1. Where the terms "service center," "the service center," "your service center," "service specialist," or "service" are used in the Owner's Manual, we wanted to clarify that the terms refer to a BMW dealer's service center or another service center or repair shop that employs trained personnel that can perform maintenance and repair work on your vehicle in accordance with BMW specifications.
2. Where the text of the Owner's Manual contains an affirmative instruction to contact a "service center" or "your service center," we wanted to clarify that BMW recommends that, if you are faced with one of the situations addressed by that text, you contact or seek the assistance of a BMW dealer's service center or another service center or repair shop that employs trained personnel that can perform maintenance and repair work on your vehicle in accordance with BMW specifications.

While BMW of North America LLC, at no cost to you, will pay for repairs

required by the limited warranties provided with respect to your vehicle and for maintenance under the Maintenance Program during the applicable warranty and maintenance coverage periods, you are free to elect, both during those periods and thereafter, to have maintenance and repair work provided by other service centers or repair shops.

3. Where the Owner's Manual makes reference to parts and accessories having been approved by BMW, those references are intended to reflect that those parts and accessories are recommended by BMW of North America LLC. You may elect to use other parts and accessories, but, if you do, we recommend that you make sure that any such parts and/or accessories are appropriate for use on your vehicle.
4. At page 7, under the "Parts and Accessories" section, in the sixth sentence, the word "cannot" should read "does not."
5. At page 55, in the "Checking and replacing safety belts" section, the text beginning, "Have the work performed only by your service center . . ." should be disregarded and the following text should be read in lieu thereof: "BMW

recommends having this work performed by a service center as it is important that this safety feature functions properly.”

6. At page 55, under the heading: “Active head restraint,” the paragraph beginning, “Only attach accessories . . .” should be disregarded and the following text should be read in lieu thereof: “BMW recommends that you attach accessories approved by BMW to the seat or head restraint.”
7. At page 101, in the “Triggered rollover protection system” section, the sentence beginning, “Have this work performed only by your service center . . .” should be disregarded and the following text should be read in lieu thereof: “BMW recommends having this work performed by a service center as it is important that this safety feature functions properly.”
8. At page 102, under the heading: “Hints,” the sentence beginning, “Only have the airbags checked . . .” should be disregarded and the following language should be read in lieu thereof: “The manufacturer of your vehicle strongly suggests that you have airbags checked, repaired or dismantled and the system scrapped by your service center or an authorized repair shop for handling explosives.”
9. At page 135, under the heading: “Special windshield,” the paragraph beginning, “Therefore, have the special windshield . . .” should be disregarded and the following text should be read in lieu thereof: “BMW recommends that you have the special windshield replaced by the service center.”
10. At page 156 under the heading: “Objects in the area around the pedals” and at page 199 under the heading: “Carpets and floor mats,” the paragraph that begins: “Only use floor mats . . .” should be disregarded and the following language should be read in lieu thereof: “The manufacturer of your vehicle recommends that you use floor mats that have been identified by it as appropriate for use in your vehicle and that can be properly fixed in place.”
11. At page 161, under the heading: “Have maintenance carried out,” the sentence beginning, “Have the maintenance carried out . . .” should be disregarded and the following text should be read in lieu thereof: “BMW recommends that you have the maintenance carried out by your service center.”
12. At page 171, under the heading: “Mounting,” the paragraph beginning, “Have mounting and balancing . . .” should be disregarded and the following text should be read in lieu thereof: “BMW recommends that you have mounting and balancing performed by your service center or a tire mounting specialist.”
13. At page 171, under the heading: “Approved wheels and tires,” the

term “Approved” should be disregarded and in lieu thereof, the term “Recommended” should be read in its place. In addition, the text of that section should be disregarded and the following text should be read in lieu thereof:

The manufacturer of your vehicle strongly suggests that you use wheels and tires that have been recommended by the vehicle manufacturer for your vehicle type; otherwise, for example, despite having the same official size ratings, variations can lead to body contact and with it, the risk of severe accidents.

The manufacturer of your vehicle does not evaluate non-recommended wheels and tires to determine if they are suitable for use on your vehicle.

14. At page 175, under the heading: “Snow Chains,” the text should be disregarded and the following text should be read in lieu thereof:

Only certain types of fine-link snow chains have been tested by the manufacturer of your vehicle and are determined by the manufacturer of your vehicle to be road safe and are recommended by the manufacturer of your vehicle.

Information about recommended snow chains is available from a service center.

15. At page 176, under the heading “Hood,” the sentence beginning, “If

you are unfamiliar” should be disregarded.

16. At page 179, under the heading: “Approved oil types,” the references to “Approved” should be read as “Suitable.” The references to “Specification” should be read as “Rating.” Immediately preceding the “Specification” chart, the following sentence should be inserted: “Add engine oils that meet the following oil rating standards: . . .”

17. At page 179, under the heading: “Alternative oil types,” the text preceding the chart should be disregarded, and in lieu thereof should be read as follows: “If an engine oil suitable for continuous use is not available, up to 1 US quart/liter of an engine oil with the following oil rating can be added: . . .” The references to “Specification” should be read as “Rating.”

18. At page 180, under the heading: “Engine oil change,” the text should be disregarded and in lieu thereof should be read as follows:

BMW recommends that you have the oil changed at your BMW dealer’s service center or at another service center that has trained personnel that can perform the work in accordance with BMW specifications

19. At page 182, under the heading: “Service and Warranty Information Booklet for US models and Warranty and Service Guide Booklet for Canadian models,” the

second paragraph should be disregarded and the following text read in lieu thereof:

The manufacturer of your vehicle recommends that you have maintenance and repair performed by your BMW dealer's service center or another service center or repair shop that employs trained personnel that can perform maintenance and repair work on your vehicle in accordance with BMW specifications. The manufacturer of your vehicle recommends that you maintain records of all maintenance and repair work performed on your vehicle.

The manufacturer of your vehicle recommends that you use vehicle batteries that it has tested and recommends for use in your vehicle; otherwise the vehicle could be damaged and systems or functions may not be fully available.

After a battery replacement, the manufacturer of your vehicle recommends that you have the battery registered on your vehicle by a service center to ensure that all comfort functions are fully available, and that any "check control" messages of these comfort functions are no longer displayed.

- 20.** At page 185, where it reads: "Do not perform work/bulb replacement on xenon headlamps," that text should be disregarded and in lieu thereof the following text should be read: "Xenon headlamp work or replacement can cause serious and fatal injuries." In the text that follows, where it reads: "[h]ave any work on the xenon lighting system . . . ," the following words should be read as preceding that passage: "It is strongly suggested that you"
- 21.** At page 188, under the "Battery replacement" section, the text should be disregarded and in lieu thereof the following text should be read:

Use of recommended vehicle batteries

Contents

The fastest way to find information on a particular topic or item is by using the index, refer to page 208.

6 Notes

At a glance

12 Cockpit
16 iDrive
22 Voice activation system
25 Integrated Owner's Manual in the vehicle

Controls

30 Opening and closing
51 Adjusting
61 Transporting children safely
64 Driving
79 Displays
93 Lamps
98 Safety
119 Driving stability control systems
123 Driving comfort
136 Climate control
141 Interior equipment
146 Storage compartments

Driving tips

152 BMW M6 technology
154 Things to remember when driving
158 Loading
160 Saving fuel

Mobility

164 Refueling
166 Fuel
167 Wheels and tires
176 Engine compartment
178 Engine oil
181 Coolant
182 Maintenance
184 Replacing components
190 Breakdown assistance
196 Care

Reference

204 Technical data
208 Everything from A to Z

Notes

Using this Owner's Manual

The fastest way to find information on a particular topic is by using the index.

An initial overview of the vehicle is provided in the first chapter.

Updates made after the editorial deadline

Any updates made after the editorial deadline for the Owner's Manuals are located in the appendix of the printed quick reference for the vehicle.

User's manual for Navigation, Entertainment, Communication

The topics of Navigation, Entertainment, Communication and the short commands of the voice activation system are described in a separate user's manual, which is also included with the onboard literature.

Additional sources of information

Should you have any questions, your service center will be glad to advise you at any time.

Information on BMW, e.g., on technology, is available on the Internet: bmwusa.com.

Symbols in the Owner's Manual

 Indicates precautions that must be followed precisely in order to avoid the possibility of personal injury and serious damage to the vehicle.

◄ Marks the end of a specific item of information.

"..." Identifies Control Display texts used to select individual functions.

»...« Verbal instructions to use with the voice activation system.

»...« Identifies the answers generated by the voice activation system.

 Refers to measures that can be taken to help protect the environment.

Symbols on vehicle components

 Indicates that you should consult the relevant section of this Owner's Manual for information on a particular part or assembly.

Vehicle equipment

This Owner's Manual describes all models and all standard, country-specific and optional equipment that is offered in the model series. Therefore, in this Owner's Manual, equipment is also described and illustrated that is not available in your vehicle, e.g., because of the selected optional equipment or the country-specific variants.

This also applies for safety-related functions and systems.

For options and equipment not described in this Owner's Manual, please refer to the Supplementary Owner's Manuals.

On right-hand drive vehicles, some controls are arranged differently than shown in the illustrations.

Status of the Owner's Manual

The manufacturer of your vehicle pursues a policy of constant development that is conceived to ensure that our vehicles continue to embody the highest quality and safety standards. In rare cases, therefore, the features de-

scribed in this Owner's Manual may differ from those in your vehicle.

Updates made after the editorial deadline

Any updates made after the editorial deadline for the Owner's Manuals are located in the appendix of the printed quick reference for the vehicle.

For your own safety

Maintenance and repairs

Advanced technology, e.g., the use of modern materials and high-performance electronics, requires suitable maintenance and repair methods.

Therefore, have this work performed only by a BMW center or a workshop that works according to BMW repair procedures with appropriately trained personnel.

If this work is not carried out properly, there is the danger of subsequent damage and related safety hazards.

Parts and Accessories

BMW recommends using parts and accessories approved by BMW for this purpose.

Your BMW center is the right contact for genuine BMW parts and accessories, other products approved by BMW and related qualified advice.

BMW has tested these products for safety and suitability in relation to BMW vehicles.

BMW can assume responsibility for them. However, we cannot assume any responsibility whatsoever for parts and accessories that have not been specifically approved by BMW.

BMW cannot evaluate whether each individual product from another manufacturer can be used with BMW vehicles without presenting a safety hazard. This guarantee is also not applicable when country-specific government approval has been granted. Testing of this kind may fail to embrace the entire range of potential operating conditions to which components might be exposed on BMW vehicles. Such products could conceivably fail to comply with BMW's own stringent quality standards.

California Proposition 65 Warning

California laws require us to state the following warning:

Engine exhaust and a wide variety of automobile components and parts, including components found in the interior furnishings in a vehicle, contain or emit chemicals known to the State of California to cause cancer and birth defects and reproductive harm. In addition, certain fluids contained in vehicles and certain products of component wear contain or emit chemicals known to the State of California to cause cancer and birth defects or other reproductive harm. Battery posts, terminals and related accessories contain lead and lead compounds. Wash your hands after handling. Used engine oil contains chemicals that have caused cancer in laboratory animals. Always protect your skin by washing thoroughly with soap and water.

Service and warranty

We recommend that you read this publication thoroughly. Your vehicle is covered by the following warranties:

- ▷ New Vehicle Limited Warranty.
- ▷ Rust Perforation Limited Warranty.
- ▷ Federal Emissions System Defect Warranty.
- ▷ Federal Emissions Performance Warranty.
- ▷ California Emission Control System Limited Warranty.

Detailed information about these warranties is listed in the Service and Warranty Information Booklet for US models or in the Warranty and Service Guide Booklet for Canadian models.

Your vehicle has been specifically adapted and designed to meet the particular operating conditions and homologation requirements in your country and continental region in order to deliver the full driving pleasure while the vehicle is operated under those conditions. If you wish to operate your vehicle in another country or region, you may be required to adapt your vehicle to meet different prevailing operating conditions and homologation requirements. You should also be aware of any applicable warranty limitations or exclusions for such country or region. In such case, please contact Customer Relations for further information.

Maintenance

Maintain the vehicle regularly to sustain the road safety, operational reliability and the New Vehicle Limited Warranty.

Specifications for required maintenance measures:

- ▷ BMW Maintenance system
- ▷ Service and Warranty Information Booklet for US models
- ▷ Warranty and Service Guide Booklet for Canadian models

If the vehicle is not maintained according to these specifications, this could result in serious damage to the vehicle. Such damage is not covered by the BMW New Vehicle Limited Warranty.

Data memory

Many electronic components on your vehicle are equipped with data memories that temporarily or permanently store technical information about the condition of the vehicle, events and faults. This technical information generally documents the state of a component, a module, a system or the environment:

- ▷ Operating states of system components, fill levels for instance.
- ▷ Status messages for the vehicle and from its individual components, e.g., wheel rotation speed/ vehicle speed, deceleration, transverse acceleration.
- ▷ Malfunctions and faults in important system components, e.g., lights and brakes.
- ▷ Responses by the vehicle to special situations, e.g., deployment of an airbag, engagement of stability control systems.
- ▷ Ambient conditions, such as temperature.

This data is purely technical in nature and is used to detect and correct faults and to optimize vehicle functions. Motion profiles over routes traveled cannot be created from this data. When service offerings are used, e.g., repair services, service processes, warranty claims, quality assurance, this technical information can be read out from the event and fault memories by the service personnel, including the manufacturer, using special diagnostic tools. You can obtain further information there if it is needed. After a fault is corrected, the information in the fault memory is deleted or overwritten on a continuous basis.

When the vehicle is in use, situations are conceivable in which it might be possible to associate this technical data with individuals if it is combined with other information, e.g., an accident report, damage to the vehicle, eye witness accounts — possibly with the assistance of an expert.

Additional functions that are contractually agreed with the customer, such as vehicle lo-

cating in an emergency, enable certain vehicle data to be transmitted from the vehicle.

Event Data Recorder EDR

This vehicle is equipped with an event data recorder EDR. The main purpose of an EDR is to record, in certain crash or near crash-like situations, such as an air bag deployment or hitting a road obstacle, data that will assist in understanding how a vehicle's systems performed. The EDR is designed to record data related to vehicle dynamics and safety systems for a short period of time, typically 30 seconds or less.

The EDR in this vehicle is designed to record such data as:

- ▶ How various systems in your vehicle were operating.
- ▶ Whether or not the driver and passenger safety belts were fastened.
- ▶ How far, if at all, the driver was depressing the accelerator and/or brake pedal.
- ▶ How fast the vehicle was traveling.

These data can help provide a better understanding of the circumstances in which crashes and injuries occur.

EDR data are recorded by your vehicle only if a nontrivial crash situation occurs; no data are recorded by the EDR under normal driving conditions and no personal data, e.g., name, gender, age, and crash location, are recorded.

However, other parties, such as law enforcement, could combine the EDR data with the type of personally identifying data routinely acquired during a crash investigation.

To read data recorded by an EDR, special equipment is required, and access to the vehicle or the EDR is needed. In addition to the vehicle manufacturer, other parties, such as law enforcement, that have the special equipment, can read the information if they have access to the vehicle or the EDR.

Reporting safety defects

For US customers

The following only applies to vehicles owned and operated in the US.

If you believe that your vehicle has a defect which could cause a crash or could cause injury or death, you should immediately inform the National Highway Traffic Safety Administration NHTSA, in addition to notifying BMW of North America, LLC, P.O. Box 1227, Westwood, New Jersey 07675-1227, Telephone 1-800-831-1117.

If NHTSA receives similar complaints, it may open an investigation, and if it finds that a safety defect exists in a group of vehicles, it may order a recall and remedy campaign.

However, NHTSA cannot become involved in individual problems between you, your dealer, or BMW of North America, LLC.

To contact NHTSA, you may call the Vehicle Safety Hotline toll-free at 1-888-327-4236 (TTY: 1-800-424-9153); go to <http://www.safercar.gov>; or write to: Administrator, NHTSA, 400 Seventh Street, SW., Washington, DC 20590. You can also obtain other information about motor vehicle safety from <http://www.safercar.gov>

For Canadian customers

Canadian customers who wish to report a safety-related defect to Transport Canada, Defect Investigations and Recalls, may telephone the toll-free hotline 1-800-333-0510. You can also obtain other information about motor vehicle safety from <http://www.tc.gc.ca/roadsafety>.



At a glance

These overviews of buttons, switches and displays are intended to familiarize you with your vehicle. You will also become quickly acquainted with the available control concepts and options.

Cockpit

Vehicle equipment

All standard, country-specific and optional equipment that is offered in the model series is described in this chapter. Therefore, equip-

ment is also described that is not available in a vehicle, e. g., because of the selected optional equipment or country variant. This also applies for safety-related functions and systems.

All around the steering wheel

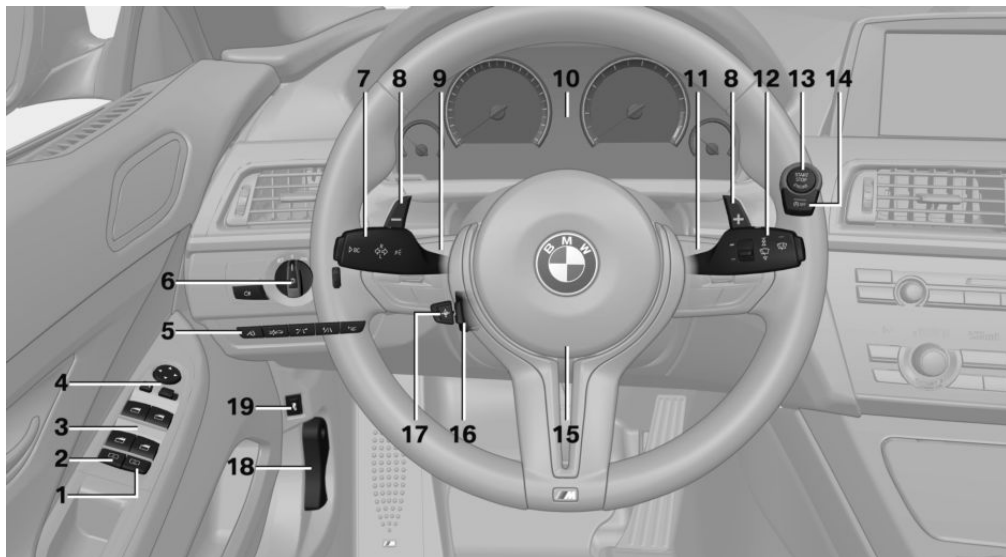

1 Opening and closing the rear window [42](#)

2 Open and close side windows and rear window together [42](#)

3 Open and close rear windows [41](#)

4 Open and close front windows [41](#)

5 Exterior mirror operation [57](#)

6 Driver assistance systems



Active Blind Spot Detection [115](#)



Intelligent Safety [105](#)



Lane departure warning [113](#)



Night Vision with pedestrian detection [110](#)



Head-up Display [133](#)

























7 Lamps



Parking lamps [93](#)









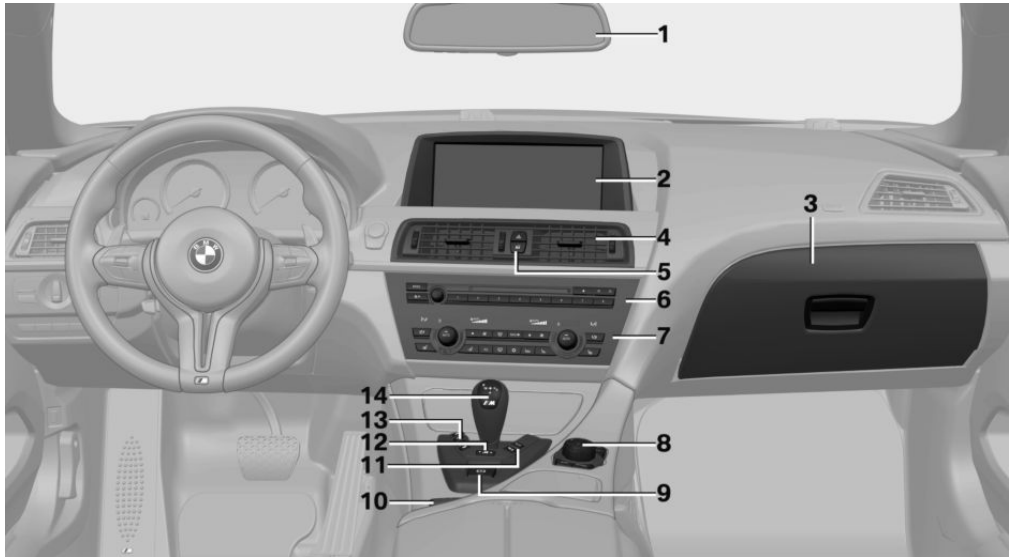



Low beams [93](#)

-  Automatic headlamp control [94](#)
 Daytime running lights [94](#)
 Adaptive Light Control [94](#)
 High-beam Assistant [95](#)
-  Instrument lighting [96](#)
- 8** Steering column stalk, left
-  Turn signal [75](#)
-  High beams, headlamp flasher [75](#)
-  High-beam Assistant [95](#)
-  Roadside parking lamps [94](#)
-  Computer [89](#)
- 9** Shift paddles [72](#)
- 10** Steering wheel buttons, left
-  M Drive 1 activation [60](#)
-  M Drive 2 activation [60](#)
-  Store speed [123](#)
-  Resume speed [124](#)
-  Cruise control on/off, interrupting [123](#)
- Cruise control rocker switch [124](#)
- 11** Instrument cluster [79](#)
- 12** Steering wheel buttons, right
-  Entertainment source
-  Volume
-  Voice activation [22](#)
-  Telephone, see user's manual for Navigation, Entertainment and Communication
- Thumbwheel for selection lists [88](#)
- 13** Steering column stalk, right
-  Windshield wipers [76](#)
-  Rain sensor [76](#)
-  Clean the windshields and headlamps [77](#)
- 14**  Start/stop the engine and switch the ignition on/off [65](#)
- 15**  Automatic Engine Start/Stop Function [66](#)
- 16** Horn
- 17**  Steering wheel heating [59](#)
- 18**  Adjust the steering wheel [59](#)
- 19** Unlocking the hood
- 20**  Open the trunk lid [37](#)

All around the center console



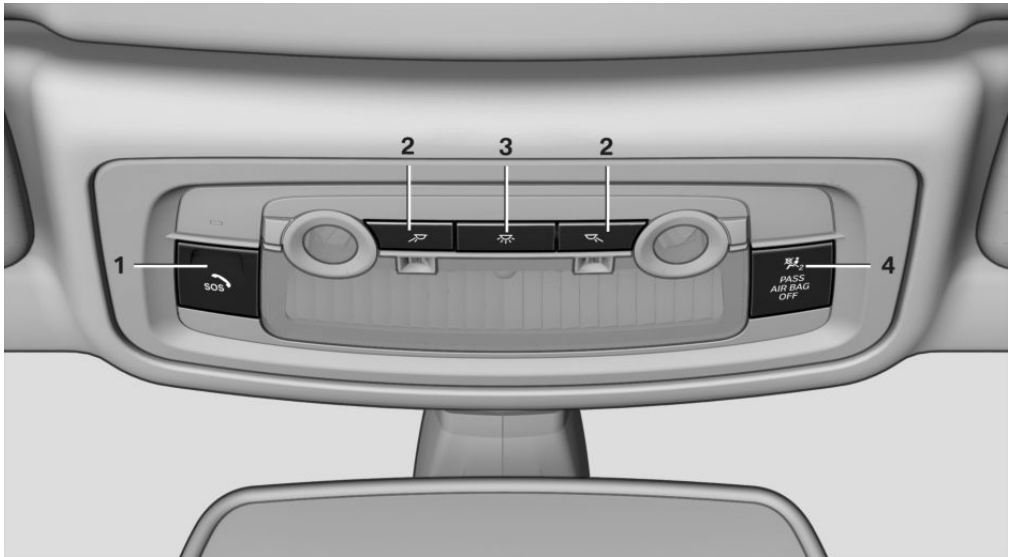

- | | |
|--|--|
| <p>1 All around the interior rearview mirror 15</p> <p>2 Control Display 16</p> <p>3 Glove compartment 146</p> <p>4 Air vent 139</p> <p>5  Hazard warning system 190</p> <p> Central locking system 36</p> <p>6 Radio/CD/Multimedia, see user's manual for Navigation, Entertainment and Communication</p> <p>7 Automatic climate control 136</p> <p>8 Controller with buttons 16</p> <p>9  Parking brake 68</p> <p>10  Opening and closing the convertible top 45</p> | <p>11  PDC Park Distance Control 125
Top View 130
Rearview camera 127
Side View 132</p> <p></p> <p>12  Drivelogic 72</p> <p>13  DSC Dynamic Stability Control 119
 Engine Dynamics 74
 Electronic Damping Control EDC 121
 Servotronic 122</p> <p>14 Transmission selector lever</p> |
|--|--|

All around the interior rearview mirror



1  Intelligent Emergency Request [190](#)

2  Reading lamps [96](#)

3  Interior lamps [96](#)

4  Indicator lamp, front passenger airbag [100](#)

iDrive

Vehicle equipment

All standard, country-specific and optional equipment that is offered in the model series is described in this chapter. Therefore, equipment is also described that is not available in a vehicle, e. g., because of the selected optional equipment or country variant. This also applies for safety-related functions and systems.

The concept

The iDrive combines the functions of a multitude of switches. Thus, these functions can be operated from a central location.

 Using the iDrive during a trip

To avoid becoming distracted and posing an unnecessary hazard to your vehicle's occupants and to other road users, never attempt to use the controls or enter information unless traffic and road conditions allow this. ◀

Controls at a glance

Controls



- 1 Control Display
- 2 Controller with buttons

The buttons can be used to open the menu directly. The controller can be used to select menu items and create the settings.

Control Display

Hints

- ▷ To clean the Control Display, follow the care instructions.
- ▷ Do not place objects close to the Control Display; otherwise, the Control Display can be damaged.

Switching off

1.  Press the button.
2. "Switch off control display"

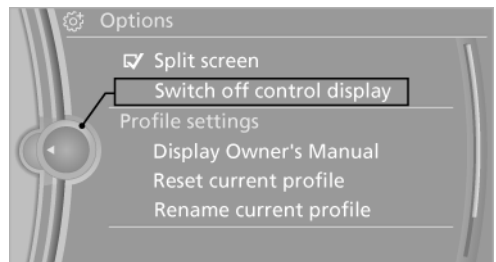

Switching on

Press the controller again to switch the screen back on.

Controller

Select menu items and create settings.

1. Turn.

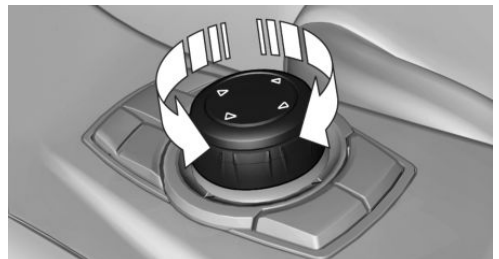

2. Press.

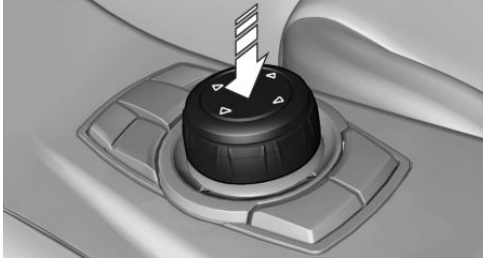

3. Move in four directions.

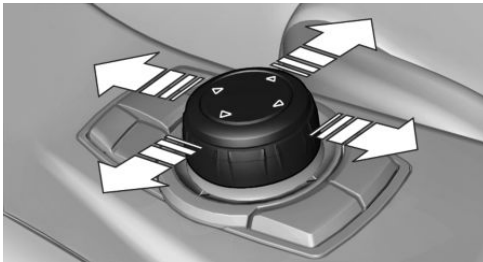

Buttons on controller

Press the button	Function
MENU	Open the main menu.
RADIO	Opens the Radio menu.
MEDIA	Opens the CD/Multimedia menu.
NAV	Opens the Navigation menu.
TEL	Opens the Telephone menu.
BACK	Displays the previous panel.
OPTION	Opens the Options menu.

Operating concept

Opening the main menu



Press the button.

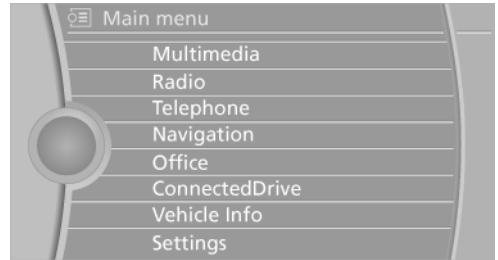

The main menu is displayed.

All iDrive functions can be called up via the main menu.

Selecting menu items

Menu items shown in white can be selected.

1. Turn the controller until the desired menu item is highlighted.

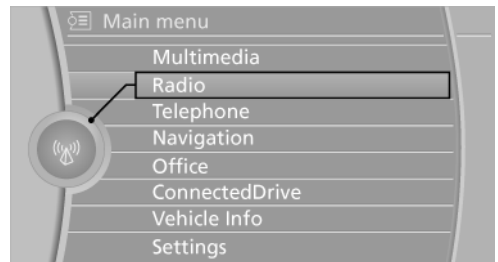

2. Press the controller.

Menu items in the Owner's Manual

In the Owner's Manual, menu items that can be selected are set in quotation marks, e.g., "Settings".

Changing between panels

After a menu item is selected, e.g., "Radio", a new panel is displayed. Panels can overlap.

- ▷ Move the controller to the left.
 - The current panel is closed and the previous panel is displayed.
 - The previous panel is opened again by pressing the BACK button. In this case, the current panel is not closed.
- ▷ Move the controller to the right.

A new panel is opened on top of the previous display.

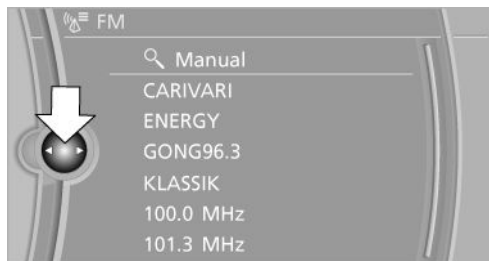

White arrows pointing to the left or right indicate that additional panels can be opened.

View of an opened menu

When a menu is opened, it generally opens with the panel that was last selected in that menu. To display the first panel of a menu:

- ▷ Move the controller to the left repeatedly until the first panel is displayed.
- ▷ Press the menu button on the controller twice.

Opening the Options menu

 Press the button.

The "Options" menu is displayed.

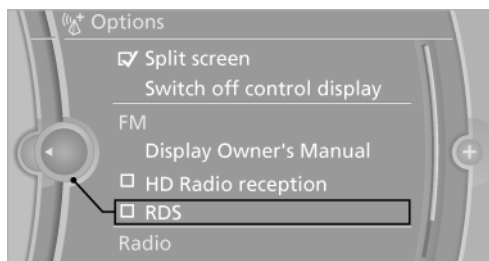

Additional options: move the controller to the right repeatedly until the "Options" menu is displayed.

Options menu

The "Options" menu consists of various areas:

- ▷ Screen settings, e.g., "Split screen".

This area remains unchanged.

- ▷ Control options for the selected main menu, e.g., for "Radio".
- ▷ If applicable, further operating options for the selected menu, e.g., "Store station".

Changing settings

1. Select a field.
2. Turn the controller until the desired setting is displayed.

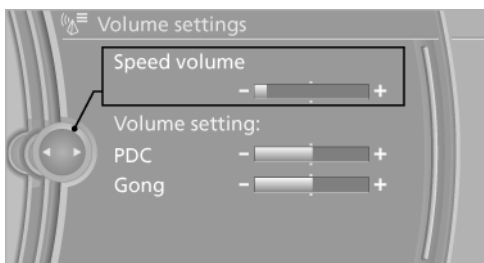

3. Press the controller.

Activating/deactivating the functions

Several menu items are preceded by a checkbox. It indicates whether the function is activated or deactivated. Selecting the menu item activates or deactivates the function.

The function is activated.

The function is deactivated.

Example: setting the clock

Setting the clock

1.  Press the button. The main menu is displayed.
2. Turn the controller until "Settings" is highlighted, and then press the controller.

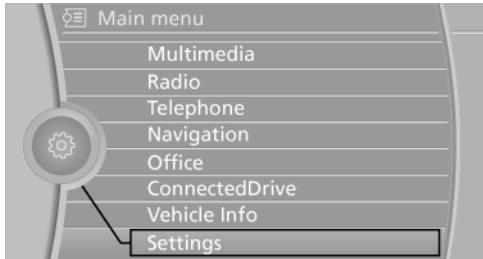

3. If necessary, move the controller to the left to display "Time/Date".
4. Turn the controller until "Time/Date" is highlighted, and then press the controller.



5. Turn the controller until "Time:" is highlighted, and then press the controller.

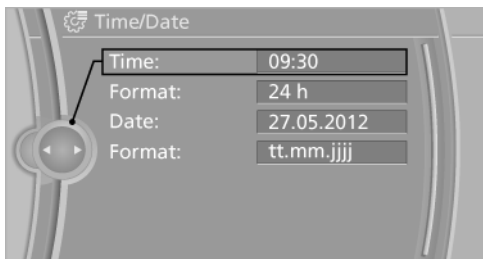

6. Turn the controller to set the hours and press the controller.
7. Turn the controller to set the minutes and press the controller.

Status information

Status field



The following information is displayed in the status field at the top right:

- ▷ Time.
- ▷ Current entertainment source.
- ▷ Sound output, on/off.
- ▷ Wireless network reception strength.
- ▷ Telephone status.
- ▷ Traffic bulletin reception.







Status field symbols

The symbols are grouped as follows.





Radio symbols

Symbol	Meaning
	HD Radio™ is switched on.
	Satellite radio is switched on.

Telephone symbols





Symbol	Meaning
	Incoming or outgoing call.
	Missed call.
	Wireless network reception strength Symbol flashes: searching for network.
	Wireless network is not available.
	Bluetooth is switched on.
	Roaming is active.

Symbol	Meaning
--------	---------

	Text message was received.
	Check the SIM card.
	SIM card is blocked.
	SIM card is missing.
	Enter the PIN.

Entertainment symbols

Symbol	Meaning
--------	---------

	CD/DVD player.
	Music collection.
	Gracenote® database.
	AUX-IN port.

Additional symbols

Symbol	Meaning
--------	---------

	Spoken instructions are switched off.
---	---------------------------------------

Split screen

General information

Additional information can be displayed on the right side of the split screen, e.g., information from the computer.

In the divided screen view, the so-called split screen, this information remains visible even when you change to another menu.

Switching the split screen on and off

-  Press the button.
- "Split screen"

Selecting the display

-  Press the button.
- "Split screen"
- Move the controller until the split screen is selected.
- Press the controller or select "Split screen content".
- Select the desired menu item.

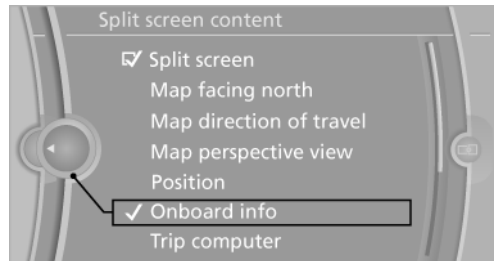

Programmable memory buttons

General information

The iDrive functions can be stored on the programmable memory buttons and called up directly, e.g., radio stations, navigation destinations, phone numbers and entry points into the menu.

The settings are stored for the remote control currently in use.

Saving a function

- Highlight the function via the iDrive.
-  Press the desired button for more than 2 seconds.

Running a function

-  Press the button.

The function will run immediately. This means, for example, that the number is dialed when a phone number is selected.

Displaying the button assignment

Use a finger to touch the buttons. Do not wear gloves or use objects.

The key assignment is displayed at the top edge of the screen.

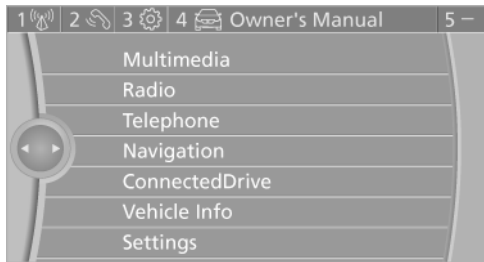

- ▷ To display short information: touch the button.
- ▷ To display detailed information: touch the button for an extended period.

Deleting the button assignments

1. Press buttons 1 and 8 simultaneously for approx. five seconds.
2. "OK"

Entering letters and numbers

General information

1. Turn the controller: select letters or numbers.
2. Select additional letters or numbers if needed.
3. "OK": confirm the entry.

Depending on the menu, you can switch between entering upper and lower case, letters and numbers:

Symbol	Function
⬅	Press the controller: delete the letter or number.
⬅	Press the controller for an extended period: delete all letters or numbers.



Switching between cases, letters and numbers

Depending on the menu, you can switch between entering upper and lower case, letters and numbers:

Symbol	Function
A ^B c	Enter the letters.
1@+	Enter the numbers.
abc or ABC	Move the controller up.

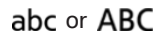

Without navigation system

@^A A^a a[@] Select the symbol.

Entry comparison

Entry of names and addresses: the selection is narrowed down every time a letter is entered and letters may be added automatically.

The entries are continuously compared to the data stored in the vehicle.

- ▷ Only those letters are offered during the entry for which data is available.
- ▷ Destination search: town/city names can be entered using the spelling of language available on the Control Display.

Voice activation system

Vehicle equipment

All standard, country-specific and optional equipment that is offered in the model series is described in this chapter. Therefore, equipment is also described that is not available in a vehicle, e. g., because of the selected optional equipment or country variant. This also applies for safety-related functions and systems.

The concept

- ▷ Most functions that are displayed on the Control Display can be operated by spoken commands via the voice activation system. The system prompts you to make your entries.
- ▷ Functions that can only be used when the vehicle is stationary cannot be operated using the voice activation system.
- ▷ The system uses a special microphone on the driver's side.
- ▷ ›...‹ Verbal instructions in the Owner's Manual to use with the voice activation system.

Requirements

Via the Control Display, set a language that is also supported by the voice activation system so that the spoken commands can be identified.

Set the language, refer to page 91.

Using voice activation

Activating the voice activation system

1.  Press the button on the steering wheel.
2. Wait for the signal.
3. Say the command.

The command is displayed in the instrument cluster.

 This symbol in the instrument cluster indicates that the voice activation system is active.

If no other commands are available, operate the function in this case via iDrive.

Terminating the voice activation system

 Briefly press the button on the steering wheel or ›Cancel‹.

Possible commands

Most menu items on the Control Display can be voiced as commands.

The available commands depend on which menu is currently displayed on the Control Display.

Short commands exist for many functions.

Some list entries, e.g., Phone book entries, can also be selected via the voice activation system. Speak these list entries exactly as they are displayed in the respective list.

Having possible commands read aloud

You can have the available commands read out loud for you: ›Voice commands‹

For example, if the "Settings" menu is displayed, the commands for the settings are read out loud.

Executing functions using short commands

Functions on the main menu can be performed directly by means of short commands, nearly irrespective of which menu item is currently selected, e.g., ›Vehicle status‹.

List of short commands of the voice activation system, see Navigation, Entertainment, Communication Owner's Manual.

Help dialog for the voice activation system

Calling up help dialog: ›Help‹

Additional commands for the help dialog:

- ▶ ›Help with examples‹: information about the current operating options and the most important commands for them are announced.
- ▶ ›Help with voice activation‹: information about the principle of operation for the voice activation system is announced.

Example: playing back a CD

Via the main menu

The commands of the menu items are spoken just as they are selected via the controller.

1. Switch on the Entertainment sound output if necessary.
2.  Press the button on the steering wheel.
3. ›Multimedia‹
The medium last played is played back.
4. ›C D‹
5. ›C D drive‹
6. ›Track ..., e.g., CD track 4.

Via short command

Playback of the CD can also be started via a short command.

1. Switch on the Entertainment sound output if necessary.
2.  Press the button on the steering wheel.
3. ›C D drive track ..., e.g., CD track 4.

Setting the voice dialog

You can set whether the system should use the standard dialog or a shorter version.

In the shorter variant of the voice dialog, the announcements from the system are issued in an abbreviated form.

On the Control Display:

1. "Settings"
2. "Language/Units"
3. "Speech mode:"
4. Select the setting.

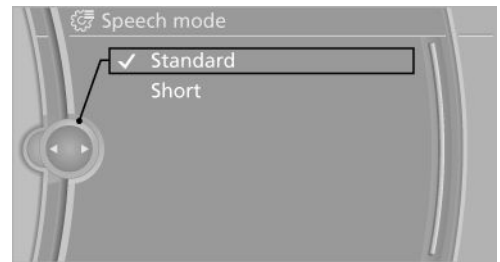

Adjusting the volume

Turn the volume button while giving an instruction until the desired volume is set.

- ▶ The volume remains constant even if the volume of other audio sources is changed.
- ▶ The volume is stored for the remote control currently in use.

Notes on Emergency Requests

Do not use the voice activation system to initiate an Emergency Request. In stressful situations, the voice and vocal pitch can change. This can unnecessarily delay the establishment of a telephone connection.

Instead, use the SOS button, refer to page 190, in the vicinity of the interior mirror.

Environmental conditions

- ▷ Say the commands, numbers, and letters smoothly and with normal volume, emphasis, and speed.
- ▷ Always say commands in the language of the voice activation system.
- ▷ Keep the doors, windows, and convertible top closed to prevent noise interference.
- ▷ Avoid making other noise in the vehicle while speaking.

Integrated Owner's Manual in the vehicle

Vehicle equipment

All standard, country-specific and optional equipment that is offered in the model series is described in this chapter. Therefore, equipment is also described that is not available in a vehicle, e. g., because of the selected optional equipment or country variant. This also applies for safety-related functions and systems.

Integrated Owner's Manual in the vehicle

The Integrated Owner's Manual can be displayed on the Control Display. The equipment and functions that are in the vehicle are described therein.

Components of the integrated Owner's Manual

The integrated Owner's Manual consists of three parts, which offer various levels of information or access possibilities.

Quick Reference Guide

Located in the Quick Reference is important information for the operation of the vehicle, the operation of basic vehicle functions or for what to do in the event of a flat tire. This information can also be displayed during driving.

Search by pictures

Information and descriptions based on illustrations can be searched via search by pictures. This is helpful, for example, if the description of an outfitting package that cannot be named is needed.

Owner's Manual

Information and descriptions can be searched by direct entry of a search term via the index.

Select components

1.  Press the button.
2. Turn the controller: open "Vehicle Info".
3. Press the controller.
4. Selecting desired range:
 - ▷ "Quick reference"
 - ▷ "Search by pictures"
 - ▷ "Owner's Manual"

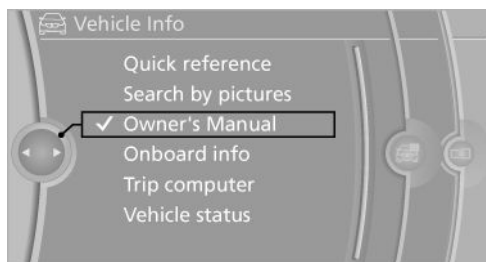

Leafing through the Owner's Manual

Page by page with link access

Turn the controller until the next or previous page is displayed.

Page by page without link access

Leaf through the pages directly while skipping the links.

Highlight the symbol once. Now simply press the controller to leaf from page to page.



Leaf back.



Leaf forward.

Context help - Owner's Manual to the temporarily selected function

The relevant information can be opened directly.

Opening via the iDrive

To move directly from the application on the Control Display to the options menu:

-  Press the button or move the controller to the right repeatedly until the "Options" menu is displayed.
- "Display Owner's Manual"



Opening when a Check Control message is displayed

Directly from the Check Control message on the Control Display:

"Display Owner's Manual"

Changing between a function and the Owner's Manual

To change from a function, e.g., radio, to the Owner's Manual on the Control Display and to switch between the two displays:

-  Press the button or move the controller to the right repeatedly until the "Options" menu is displayed.
- "Display Owner's Manual"
- Select the desired page in the Owner's Manual.
-  Press the button again to return to the function displayed last.
-  Press the button to return to the page of the Owner's Manual displayed last.

To switch back and forth repeatedly between the function displayed last and the page of the Owner's Manual displayed last, repeat steps 4 and 5. This opens a new panel every time.

Programmable memory buttons

General information

The Owner's Manual can be stored on the programmable memory buttons and called up directly.

Storing

- "Owner's Manual" Select via the iDrive.
-  Press the desired button for more than 2 seconds.

Executing

-  Press the button.
The Owner's Manual is displayed immediately.



Controls

This chapter is intended to provide you with information that will give you complete control of your vehicle. All features and accessories that are useful for driving and your safety, comfort and convenience are described here.

Opening and closing

Vehicle equipment

All standard, country-specific and optional equipment that is offered in the model series is described in this chapter. Therefore, equipment is also described that is not available in a vehicle, e. g., because of the selected optional equipment or country variant. This also applies for safety-related functions and systems.

Remote control/key

Buttons on the remote control

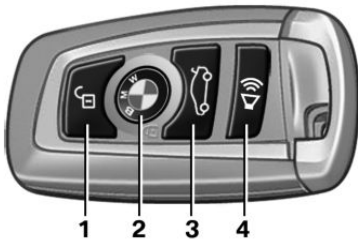

- 1 Unlocking
- 2 Locking
- 3 Trunk lid
- 4 Panic mode, headl. courtesy delay feat.

General information

The vehicle is supplied with two remote controls with keys.

Every remote control contains a replaceable battery.

The settings called up and implemented when the car is unlocked depend on which remote control is used to unlock the car. Personal Profile, refer to page 31.

Information on the required maintenance is stored in the remote control as well. Service data in the remote control, refer to page 182

Integrated key

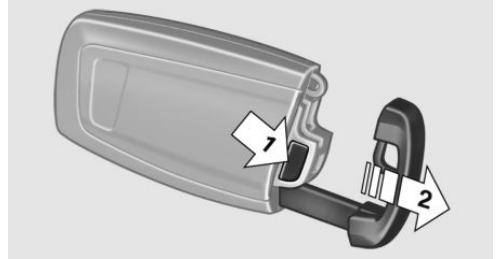

Press the button on the back of the remote control, arrow 1, and pull out the key, arrow 2.

The integrated key fits the following locks:

- ▷ Driver's door.
- ▷ Storage compartment in the center armrest.

The storage compartment contains a switch for separately securing the trunk lid, refer to page 37.

Replacing the battery

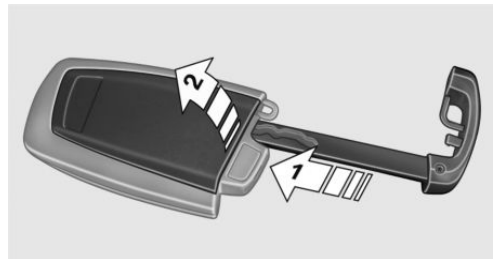

1. Take the integrated key out of the remote control.
2. Push in the catch with the key, arrow 1.
3. Remove the cover of the battery compartment; see arrow 2.
4. Insert a battery of the same type with the positive side facing upwards.
5. Press the cover closed.



Take the used battery to a recycling center or to your service center.

New remote controls

You can obtain new remote controls from your service center.

Loss of the remote controls

Lost remote controls can be blocked by your service center.

Emergency detection of remote control

It is possible to switch on the ignition or start the engine in situations such as the following:

- ▷ Interference of radio transmission to remote control by external sources.
- ▷ Discharged battery in the remote control.
- ▷ Interference of radio transmission by mobile devices in close proximity to the remote control.
- ▷ Interference of radio transmission by charger while charging items such as mobile devices in the vehicle.

A Check Control message is displayed if an attempt is made to switch on the ignition or start the engine.

Starting the engine with emergency detection of the remote control



Double-clutch transmission: if a corresponding Check Control message appears, hold the remote control, as shown, against the marked area on the steering column and press the

Start/Stop button within 10 seconds while pressing the brake.

Manual transmission: if a corresponding Check Control message appears, hold the remote control, as shown, against the marked area on the steering column and press the Start/Stop button within 10 seconds while pressing the clutch pedal.

Personal Profile

The concept

You can set several of your vehicle's functions to suit your personal needs and preferences.

- ▷ The settings are automatically saved in the profile currently activated.
- ▷ The remote control used is detected when the vehicle is unlocked and the stored profile is called up.
- ▷ Your personal settings will be recognized and called up again even if the vehicle has been used in the meantime by someone else with another remote control.

The individual settings are stored for three Personal Profiles and one guest profile.

Transmitting the settings

Your personal settings can be taken with you to another vehicle equipped with the Personal Profile function. For more information, contact your service center.

Transmission takes place via:

- ▷ The USB interface in the center armrest onto a USB device.
- ▷ BMW Online.

Profile management

Opening the profiles

A different profile can be called up than the one associated with the remote control currently in use.

1. "Settings"
2. "Profiles"
3. Select a profile.

Called up profile is assigned to the remote control being used at the time.

Renaming profiles

1. "Settings"
2. "Profiles"
The current profile is selected.
3. Open "Options".
4. "Rename current profile"

Resetting profiles

The settings of the active profile are reset to their default values.

1. "Settings"
2. "Profiles"
The current profile is selected.
3. Open "Options".
4. "Reset current profile"

Importing profiles

Existing settings and contacts are overwritten with the imported profile.

1. "Settings"
2. "Profiles"
3. "Import profile"
4. BMW Online: "BMW Online"
USB interface, refer to page 146: "USB device"

Exporting profiles

Most settings of the active profile and the saved contacts can be exported.

This can be helpful for securing and retrieving personal settings, before delivering the vehicle to a workshop for example.

1. "Settings"
2. "Profiles"
3. "Export profile"
4. BMW Online: "BMW Online"
USB interface, refer to page 146: "USB device"

Using the guest profile

The guest profile can be used to make individual settings without affecting the three Personal Profiles.

This can be useful for drivers who are using the vehicle temporarily and do not have their own profile.

1. "Settings"
2. "Profiles"
The current profile is selected.
3. Open "Guest".
4. Create the settings.

Note: the guest profile cannot be renamed.

Display profile list during start

The profile list can be displayed during each start for selecting the desired profile.

1. "Settings"
2. "Profiles"
3. Open "Options".
4. "Display user list at startup"

Personal Profile settings

The following functions and settings can be stored in a profile.

- ▷ Collision warning; warning time.

- ▷ Exterior mirror position.
- ▷ CD/Multimedia: audio source listened to last.
- ▷ Unlocking/locking of the vehicle: settings.
- ▷ Driver's seat position: automatic retrieval after unlocking.
- ▷ Programmable memory buttons: assignment.
- ▷ Head-up Display: selection, brightness, position and rotation of the display.
- ▷ Headlamp courtesy delay feature: time setting.
- ▷ Tone: tone settings.
- ▷ Automatic climate control: settings.
- ▷ Steering wheel position.
- ▷ M Drive: configurations.
- ▷ Navigation: map views, route criteria, voice output on/off.
- ▷ Night Vision with pedestrian detection.
- ▷ Intelligent Safety: individual settings.
- ▷ Park Distance Control PDC: adjusting the signal tone volume.
- ▷ Radio: stored stations, station listened to last, special settings.
- ▷ Rearview camera: selection of functions and type of display.
- ▷ Side View: selection of the display type.
- ▷ Language on the Control Display.
- ▷ Lane departure warning: last setting, on/off.
- ▷ Active Blind Spot Detection: last setting, on/off.
- ▷ Daytime running lights: current setting.
- ▷ Triple turn signal activation.
- ▷ Locking the vehicle: after a brief period or after starting to drive.

Central locking system

The concept

The central locking system becomes active when the driver's door is closed.

The system simultaneously engages and releases the locks on the following:

- ▷ Doors.
- ▷ Compartment in the center armrest.
- ▷ Trunk lid.
- ▷ Fuel filler flap.

Operating from the outside

- ▷ Via the remote control.
- ▷ Via the driver's door lock.
- ▷ Via the door handles.
- ▷ Via the button in the trunk lid.

The following takes place simultaneously when locking/unlocking the vehicle via the remote control:

- ▷ Depending on how the vehicle is equipped, the theft protection is activated/deactivated. Theft protection prevents the doors from being unlocked using the lock buttons or the door opener.
- ▷ The welcome lamps, interior lamps and courtesy lamps are switched on and off.
- ▷ The alarm system, refer to page 40, is armed or disarmed.

Operating from the inside

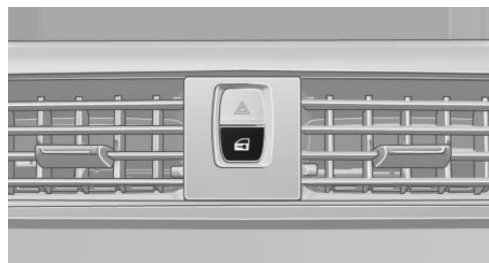

Via the button for the central locking system.

If the vehicle has been locked from inside, the fuel filler flap and the compartment in the center armrest remain unlocked.

If an accident of a certain severity occurs, the central locking system unlocks automatically. The hazard warning system and interior lamps come on.

Opening and closing: from the outside

Using the remote control

General information

 Take the remote control with you. People or animals left unattended in a parked vehicle can lock the doors from the inside. Always take the remote control with you when leaving the vehicle so that the vehicle can then be opened from the outside. ◀

Unlocking

 Press the button on the remote control.

The vehicle is unlocked.

Welcome lamps, interior lamp and courtesy lamps are switched on.

You can set how the vehicle is to be unlocked. Create the settings, refer to page 39.

Convenient opening

 Press and hold the button on the remote control.

The side windows and the rear window are fully opened.

With Comfort Access, the remote control can be used to open the convertible top when in the vicinity of the vehicle.



Press and hold the button on the remote control until the convertible top is fully opened and the convertible top well storage cover is fully closed.



Danger of pinching
Monitor the opening process to ensure that no one becomes trapped; otherwise, injuries may result. ◀

Releasing the button stops the motion.

Leaving the vicinity of the vehicle stops the motion of the convertible top.

After a short period, the convertible top and the convertible top well storage cover are lowered slowly. The convertible top and the convertible top well storage cover are not locked. Press the button again until the convertible top operation is completed.

Locking



Press the button on the remote control.



Locking from the outside
Do not lock the vehicle from the outside if there are people in it, as the vehicle cannot be unlocked from inside without special knowledge. ◀

Convenient closing

With Comfort Access, the remote control can be used to close the convertible top, the side windows, and the rear window when in the vicinity of the vehicle.



Hold down the remote control button until the closing operation is completed.



Monitor the closing process
Monitor the closing process to ensure that no one becomes trapped. ◀

Releasing the button or leaving the vicinity of the vehicle stops the motion.

After a short period, the convertible top and the convertible top well storage cover are lowered slowly. The convertible top and the convertible top well storage cover are not locked. Press the button again until the convertible top operation is completed.

Switching on interior lamps and courtesy lamps



Press the button on the remote control with the vehicle locked.

Panic mode

You can trigger the alarm system if you find yourself in a dangerous situation.



Press the button on the remote control for at least 3 seconds.

To switch off the alarm: press any button.

Switching on the headlamp courtesy delay feature



Briefly press the button on the remote control.

The duration can be set in the Control Display.

Opening the trunk lid



Press the button on the remote control for approx. 1 second.

The trunk lid opens, regardless of whether it was previously locked or unlocked.

In some vehicle equipment variants, the trunk lid can only be opened using the remote control if the vehicle has been unlocked.



Do not place the remote control in the cargo area

Take the remote control with you and do not leave it in the cargo area; otherwise, the remote control is locked inside the vehicle when the trunk lid is closed. ◀

The trunk lid is locked again as soon as it is pushed closed.

Malfunction

If the vehicle can no longer be locked or unlocked with the remote control, the battery may be discharged or there may be interference from external sources such as mobile phones, metal objects, overhead power lines, transmission towers, etc.

If this occurs, lock or unlock the driver's door at the door lock using the integrated key.

For US owners only

The transmitter and receiver units comply with part 15 of the FCC/Federal Communication Commission regulations. Operation is governed by the following:

FCC ID:

- ▷ LX8766S.
- ▷ LX8766E.
- ▷ LX8CAS.
- ▷ LX8CAS2.
- ▷ MYTCAS4.

Compliance statement:

This device complies with part 15 of the FCC Rules. Operation is subject to the following two conditions:

- ▷ This device may not cause harmful interference, and
- ▷ this device must accept any interference received, including interference that may cause undesired operation.

Any unauthorized modifications or changes to these devices could void the user's authority to operate this equipment.

Using the door lock

General information

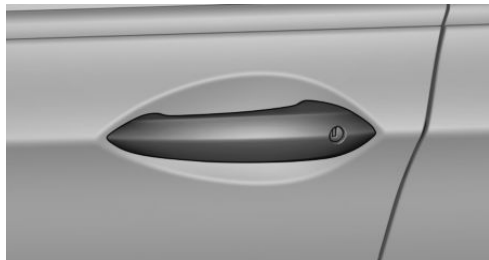

Locking from the outside

Do not lock the vehicle from the outside if there are people in it, as the vehicle cannot be unlocked from inside without special knowledge. ◀

Remove the key before pulling the door handle

Before pulling the outside door handle, remove the key to avoid damaging the paintwork and the key. ◀

In some country-specific versions, the alarm system is triggered if the vehicle is unlocked via the door lock.

In order to terminate this alarm, unlock vehicle with the remote control or switch on the ignition, if necessary, by emergency detection of the remote control.

In some vehicle equipment versions, only the driver's door can be unlocked or locked via the door lock.

Locking the doors and trunk lid at once

To lock all doors and the trunk lid at once:

1. With the doors closed, lock the vehicle using the button for the central locking system in the interior.
2. Unlock and open the driver's or front passenger door.
3. Lock the vehicle.

- ▷ Lock the driver's door using the integrated key in the door lock, or
- ▷ Press down the lock button of the front passenger door and close the door from the outside.

The fuel filler flap can only be locked using the remote control.

Manual operation

If an electrical malfunction occurs, lock or unlock the vehicle using the integrated key via the door lock on the driver's door.

Opening and closing: from the inside

Locking and unlocking

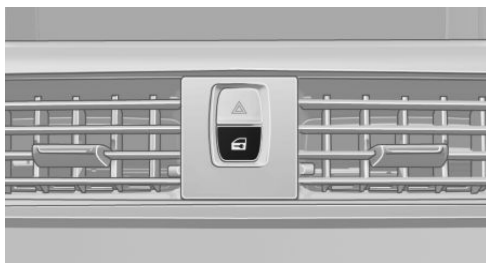

Pressing the buttons locks and unlocks the doors and the trunk lid when the doors are closed, but they are not secured against theft.

The fuel filler flap remains unlocked.

Unlocking and opening

- ▷ Either unlock the doors together using the button for the central locking system and then pull the door handle above the armrest or
- ▷ Pull the door opener twice individually on each door: the first time unlocks the door, the second time opens it.

Doors

Automatic Soft Closing

To close the doors, push lightly.
It is closed automatically.

-  Danger of pinching
Make sure that the closing path of the doors is clear; otherwise, injuries may result. ◀

Trunk lid

Opening

During opening, the trunk lid pivots back and up.

Ensure that adequate clearance is available before opening.

Opening from the outside

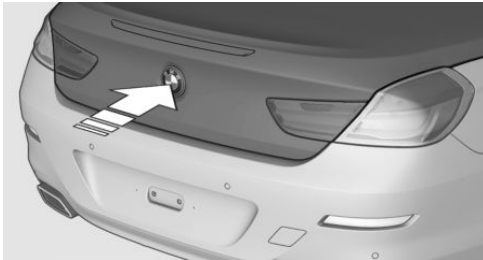

- ▷ Press on the top half of the BMW emblem.
- ▷  Press the button on the remote control for approx. 1 second.

The trunk lid cannot be opened if the convertible top is not fully opened or closed.

Opening from the inside

-  Push the button in the driver's footwell.

If the vehicle is stationary, the trunk lid opens if it is not locked.

Closing



Recessed grips in the interior trim of the trunk lid make it easier to pull down the lid.

-  Keep the closing path clear
Make sure that the closing path of the trunk lid is clear; otherwise, injuries may result. ◀

-  Do not place the remote control in the cargo area

Take the remote control with you and do not leave it in the cargo area; otherwise, the remote control is locked inside the vehicle when the trunk lid is closed. ◀

Locking the vehicle



Press the button on the inside of the trunk lid. When the driver's door is closed, the vehicle is completely locked.

Locking separately

The trunk lid can be locked separately with the switch in the front passenger glove compartment.



- ▷ Trunk lid secured, arrow 1.
- ▷ Trunk lid not secured, arrow 2.

Slide the switch into the arrow 1 position. This secures the trunk lid and disconnects it from the central locking system.

If the center arm rest is locked with the integrated key, the trunk lid cannot be opened.

This is beneficial when the vehicle is parked using valet service. The infrared remote control can be handed out without the key.

Emergency unlocking



Pull the handle inside the cargo area.
The trunk lid unlocks.

Comfort Access

The concept

The vehicle can be accessed without activating the remote control.

All you need to do is to have the remote control with you, e.g., in your jacket pocket.

The vehicle automatically detects the remote control when it is nearby or in the passenger compartment.

Comfort Access supports the following functions:

- ▷ Unlocking/locking of the vehicle.
- ▷ Unlocking of the trunk lid separately.

- ▷ Start the engine.

Functional requirements

- ▷ There are no external sources of interference nearby.
- ▷ To lock the vehicle, the remote control must be located outside of the vehicle.
- ▷ The next unlocking and locking cycle is not possible until after approx. 2 seconds.
- ▷ The engine can only be started if the remote control is inside the vehicle.

Comparison with ordinary remote control

The functions can be controlled by pressing the buttons of the remote control or Comfort Access.

Unlocking

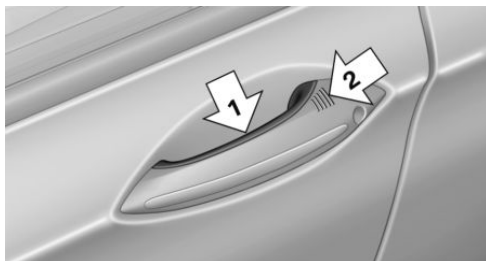

Fully grasp a door handle, arrow 1.

This corresponds to pressing the  button on the remote control.

Locking

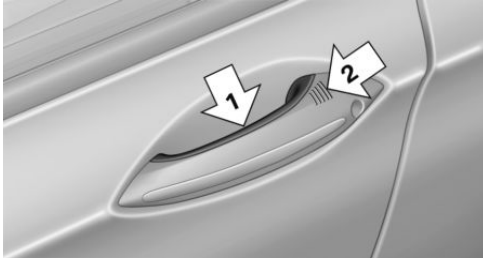

Press the area on the door handle, arrow 2, with your finger for approx. 1 second.

This corresponds to pressing the  button on the remote control.

To save battery power, ensure that the ignition and all electronic systems and/or power consumers are switched off before locking the vehicle.

Unlocking the trunk lid separately

Press on the top half of the BMW emblem on the trunk lid.

This corresponds to pressing the  button on the remote control.

 Do not place the remote control in the cargo area

Take the remote control with you and do not leave it in the cargo area; otherwise, the remote control is locked inside the vehicle when the trunk lid is closed. ◀

Malfunction

Comfort Access may not function properly if it experiences interference from external sources such as mobile phones, metal objects, overhead power lines, transmission towers, etc.

In this case, open or close the vehicle using the buttons on the remote control or use the integrated key in the door lock.

Adjusting

Unlocking

The setting is stored for the remote control currently in use.

1. "Settings"
2. "Doors/key"
3.  Select symbol or "Unlock button:"
4. Select the desired function:
 - ▷ "Driver's door only"

Only the driver's door and the fuel filler flap are unlocked. Pressing again unlocks the entire vehicle.
 - ▷ "All doors"

The entire vehicle is unlocked.

Depending on how the vehicle is equipped or the country-specific variant, you can set whether the doors are also unlocked with the  button on the remote control.

Confirmation signals from the vehicle

1. "Settings"
2. "Doors/key"
3. Deactivate or activate the desired confirmation signals.
 - ▷ "Acoustic sig. lock/unlock"
 - ▷ "Flash when lock/unlock"

Automatic locking

The setting is stored for the remote control currently in use.

1. "Settings"
2. "Doors/key"
3. Select the desired function:
 - ▷ "Lock if no door opened"

The vehicle locks automatically after a short period of time if a door is not opened.
 - ▷ "Lock after start driving"

The vehicle locks automatically after you drive away.

Retrieving the seat, mirror, and steering wheel settings

The driver's seat, exterior mirror, and steering wheel positions selected last are stored for the currently used remote control.

When the vehicle is unlocked, these positions are automatically retrieved if this function was activated.

 Pinch hazard when moving back the seat

If this function is used, first make sure that the footwell behind the driver's seat is empty. Otherwise, people can be injured or objects damaged when the seat is moved back. ◀

The adjustment procedure is interrupted:

- ▷ When a seat position switch is pressed.
- ▷ When a button of the seat, mirror, and steering wheel memory is pressed briefly.

Activating the setting

1. "Settings"
2. "Doors/key"
3. "Last seat position autom."

Alarm system

The concept

The vehicle alarm system responds to:

- ▷ Opening of a door, the hood or the trunk lid.
- ▷ Movements in the vehicle.
- ▷ Changes in the vehicle tilt, e.g., during attempts to steal a wheel or when towing the car.
- ▷ Interruptions in battery voltage.

The alarm system briefly indicates tampering:

- ▷ By sounding an acoustic alarm.

- ▷ By switching on the hazard warning system.
- ▷ By flashing the high beams.

Arming and disarming the alarm system

General information

When you lock or unlock the vehicle, either with the remote control, Comfort Access or at the door lock the alarm system is armed or disarmed at the same time.

Door lock and armed alarm system

Unlocking via the door lock will trigger the alarm on some country-specific versions.

In order to terminate this alarm, unlock vehicle with the remote control or switch on the ignition, if necessary, by emergency detection of the remote control.

Trunk lid and armed alarm system

The trunk lid can be opened even when the alarm system is armed.



Press the button on the remote control for approx. 1 second.

After the trunk lid is closed, it is locked and monitored again if the doors are locked. The hazard warning system flashes once.

In some vehicle equipment variants, the trunk lid can only be opened using the remote control if the vehicle was unlocked first.

Panic mode

You can trigger the alarm system if you find yourself in a dangerous situation.



Press the button on the remote control for at least 3 seconds.

To switch off the alarm: press any button.

Switching off the alarm

- ▶ Unlock the vehicle using the remote control.
- ▶ With Comfort Access: If you are carrying the remote control with you, pull on the driver side or front passenger side door handle.

Indicator lamp on the interior rearview mirror

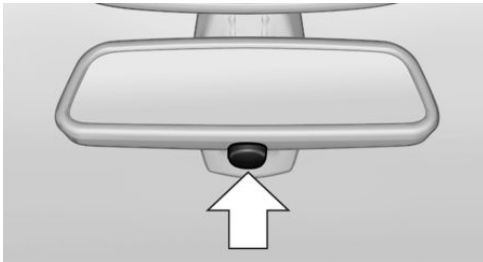

- ▶ The indicator lamp flashes briefly every 2 seconds:
The system is armed.
- ▶ The indicator lamp flashes after locking:
The doors, hood or trunk lid is not closed properly, but the rest of the vehicle is secured.
After 10 seconds, the indicator lamp flashes continuously. Interior motion sensor and tilt alarm sensor are not active.
- ▶ The indicator lamp goes out after unlocking:
The vehicle has not been tampered with.
- ▶ The indicator lamp flashes after unlocking until the engine ignition is switched on, but no longer than approx. 5 minutes:
An alarm has been triggered.

Tilt alarm sensor

The tilt of the vehicle is monitored.

The alarm system responds in situations such as attempts to steal a wheel or when the car is towed.

Interior motion sensor

The interior is monitored to the height of the seat cushions. The alarm system is armed together with the interior motion sensor even when the convertible top is open. Falling objects such as leaves can trigger the alarm unintentionally.

Avoiding unintentional alarms

The tilt alarm sensor and interior motion sensor can be switched off together, such as in the following situations:

- ▶ In automatic car washes.
- ▶ In duplex garages.
- ▶ During transport on car-carrying trains, at sea or on a trailer.
- ▶ When animals are to remain in the vehicle.

Switching off the tilt alarm sensor and interior motion sensor

 Press the remote control button again within 10 seconds as soon as the vehicle is locked.

The indicator lamp lights up for approx. 2 seconds and then continues to flash.

The tilt alarm sensor and interior motion sensor are switched off until the vehicle is locked again.

Power windows

General information

 Take the remote control with you
Take the remote control with you when leaving the vehicle so that children, for example, cannot operate the power windows and injure themselves. ◀





Closing the windows when driving

To close the side windows when driving, first close the rear windows or all four windows at the same time; otherwise, the windows may not close tightly at high speeds. ◀



Opening individually

- ▷  Press the switch to the resistance point.
The window opens while the switch is held.
- ▷  Press the switch beyond the resistance point.
The window opens automatically.

Pressing the switch again stops the motion.



Convenient opening, refer to page 34, via the remote control.

Closing individually





Keep the closing path clear

Monitor the closing process and make sure that the closing path of the window is clear; otherwise, injuries may result. ◀



- ▷  Pull the switch to the resistance point.
The window closes while the switch is held.
- ▷  Pull the switch beyond the resistance point.
The window closes automatically.

Pressing the switch stops the motion.

Opening together



- ▷  Press the switch to the resistance point.
All windows, including the rear window, open while the switch is being pressed.
- ▷  Press the switch beyond the resistance point.
All windows, including the rear window, open automatically.
Pressing again stops the motion.

Closing together

- ▷  Pull the switch to the resistance point.
All windows, including the rear window, are closed while the switch is being pressed.
- ▷  Pull the switch beyond the resistance point.
All windows, including the rear window, are closed while the switch is being pressed. As soon as the rear window is closed, the side windows are automatically closed by pulling the switching beyond the resistance point.
Pressing the switch stops the motion.

Rear window

Opening

- ▷  Press the switch to the resistance point.
The rear window opens while the switch is being held.
- ▷  Press the switch beyond the resistance point.
The rear window opens automatically.

The rear window opens and closes automatically when the convertible top is opened or closed.

Closing



Pull the switch.

The rear window closes while the switch is being held.

Pinch protection system

If the closing force exceeds a specific value as a window closes, the closing action is interrupted.

The window reopens slightly.

The rear window is not equipped with pinch protection.



Danger of pinching even with pinch protection

Even with the pinch protection system, check that the window's closing path is clear; otherwise, the closing action may not stop in certain situations, e.g., if thin objects are present. ◀



No window accessories

Do not install any accessories in the range of movement of the windows; otherwise, the pinch protection system will be impaired. ◀

Closing without the pinch protection system



Keep the closing path clear

Monitor the closing process and make sure that the closing path of the window is clear; otherwise, injuries may result. ◀

For example, if there is an external danger or if ice on the windows prevents a window from closing normally, proceed as follows:

1. Pull the switch past the resistance point and hold it there.

The pinch protection is limited and the window reopens slightly if the closing force exceeds a certain value.

2. Pull the switch past the resistance point again within approx. 4 seconds and hold it there.

The window closes without pinch protection.

Convertible top

General information

The convertible top can be opened or closed at speeds up to approx. 25 mph/40 km/h.

If the vehicle is accelerated above a speed of approx. 30 mph/50 km/h while the convertible top is being moved, the convertible top movement stops.

Tips about the convertible top:

- ▶ If possible, close the convertible top when the vehicle is parked. A closed convertible top protects it from weather-related damage and to some extent from theft.
- ▶ Event when the convertible top is closed, only store valuables in the locked cargo area.
- ▶ At higher speeds, vacuum produced in the passenger compartment cause the convertible top to begin to flatten. Increase the amount of air via the automatic climate control so that no vacuum is produced in the vehicle.

Hints

The trunk lid cannot be opened if the convertible top is not fully opened or closed.



Safety information about the convertible top

- ▶ With temperatures below +14 °F/-10 °C do not open the convertible top; otherwise damages could result.

- ▷ Do not leave the open convertible top in the convertible top well longer than one day while the top is still wet; otherwise, damage could result due to moisture.
- ▷ When opening the convertible top, make sure there are no foreign bodies on top of it.
- ▷ The convertible top pivots up during opening and closing. When the top is moved, e.g., in garages, make sure that there is a minimum height of 79 inches/2 meters; otherwise, it damages may result.
- ▷ Do not place any objects on the convertible top, otherwise, they could fall and cause damage or injuries.
- ▷ When the rollover protection system is extended, do not under any circumstances move the convertible top.
- ▷ Always open or close the convertible top completely. Convertible top and convertible top well storage cover are locked in the final positions. Driving with the convertible tope or convertible top well storage cover unlocked can result in damage.
- ▷ Do not reach into the convertible top mechanism during the opening and closing operation. Keep children away from the opening path of the convertible top, otherwise, there is a risk of injury.
- ▷ When the convertible top is opened during driving, be alert to traffic; otherwise, it may result in an accident. If possible, do not move the convertible top while driving in reverse because rearward vision is severely impaired while the convertible top is in motion. During windy conditions, do not operate the convertible top while driving. Do not drive faster than 30 mph/50 km/h; otherwise, vehicle damage may occur.
- ▷ Do not attach any roof carrier systems; otherwise, an accident may occur. ◀

Functional requirements

The ignition or radio ready state must be switched on.

It is not possible to start the engine and operate the convertible top simultaneously. When the engine is started, the convertible top movement is briefly interrupted.

Under the following conditions, the convertible top movement cannot be moved and a Check Control message is displayed.

- ▷ Cargo area partition is flipped up.
- ▷ Trunk lid is open.
- ▷ External temperature is too low.
- ▷ Vehicle system too low.
- ▷ Convertible top drive is overheating.
- ▷ Movement of the convertible top not allowed because of national regulations.
- ▷ Vehicle speed is too high.

Before opening and closing

- ▷ Follow the safety instructions for the convertible top.
- ▷ Make sure that the cargo area partition in the cargo area is folded down.
- ▷ Make sure that the cargo does not push against the cargo area partition from below.
- ▷ Make sure that the trunk lid is closed.

Convertible top switch





- 1 Switch
- 2 LEDs

Opening and closing from the inside

In order to protect the battery, move the convertible top only when the engine is running if possible.

Before closing the convertible top, remove any foreign objects from the windshield frame; otherwise, closing may be prevented.

- ▶  Press and hold the switch. The convertible top opens while the switch is being pressed.
- ▶  Pull the switch and hold it. The convertible top closes while the switch is being pulled.

Push or pull switch until the convertible top is completely open or closed and the end of the procedure is indicated by a corresponding Check Control message. Always make sure that the convertible top well storage cover is completely closed. If the convertible top is completely open or closed, convertible top and convertible top well storage cover are latched.

The side windows and the rear window go down when the convertible top control switch is pulled or pushed.

LEDs

- ▶ Left LED lights up green: convertible top is opened or closed. If the operation is completed, the LED goes out and a corresponding Check Control message is displayed.
- ▶ Right LED flashes red after the switch is released: operating sequence has not yet concluded.
- ▶ Right LED comes on red when the switch is pressed: cargo area partition is flipped up, trunk lid is not closed or there is a malfunction. Convertible top cannot be moved.

In addition to the red LED, a check control message is displayed.

Interruption



Always open/close the convertible top completely

A convertible top that is not opened or closed completely is not locked and represents a hazard. ◀

The convertible top movement is interrupted if the switch is released. The sequence can be continued in the desired direction using the switch.

If there is a longer interruption, convertible top and convertible top well storage cover remain approx. 10 minutes in the current position before they slowly go down. The convertible top and the convertible top well storage cover are not locked. Operate switch again until the convertible operation is terminated.

Convenient operation from outside

When equipped with Comfort Access the convertible top can also be operated from outside:

- ▶ Convenient opening with remote operation, refer to page 34.
- ▶ Convenient closing with the remote control, refer to page 34.

Cargo area partition

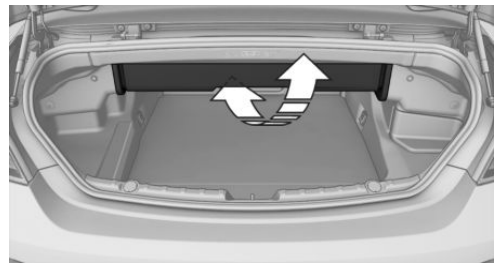

Fold down cargo area partition in the back so that the convertible top can be opened.

Fold down cargo area partition in the front in order to enlarge the cargo area capacity when the convertible top is closed.

Manually close convertible top

If there is a defect, the convertible top can be manually closed. Two persons are necessary to do this.

 Do not manually open convertible top and close it manually only in emergency situations.

Do not manually open the convertible top. The convertible top well storage cover cannot latch if there is an electrical defect and would open during driving.

Manually close the convertible top only in emergency situations.

Damage can result from improper handling. ◀

Tools

Tools for manually closing the convertible top are located in the insert of the rear seat backrest under the first aid kit.

1. Remove insert, refer to page 191.
2. Remove the first aid kit.
3. Remove tools.

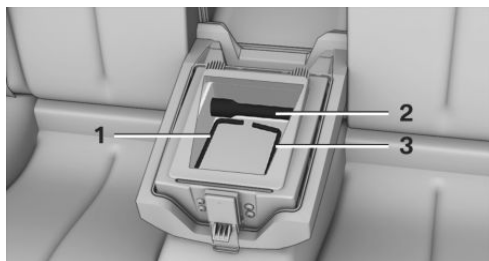

- 1 Convertible top tool
- 2 Adapter
- 3 Rear window tool

Before closing

1. Switch off the ignition.
2. Lower the side window and the rear window completely.

If the rear window cannot be lowered electrically, it must be lowered manually.

3. Carefully open the trunk lid, refer to page 37, taking care not to damage the convertible top well storage cover.
4. Remove the two large caps from the trim. If necessary, use a screwdriver to help with this.



5. Unlock convertible top well storage cover. To do this, pull on the right cap and simultaneously slightly raise the front right convertible top well storage cover in front of the rear window.
Proceed accordingly on the left side.
6. When the convertible top is closed manually, the trunk lid can no longer be opened.

Remove urgently needed items from the cargo area and close the trunk lid.

Manually lowering rear window

The spindle for lowering the rear window is located in front of the rear window in the center beneath the convertible top well storage cover.

1. Have a second person slightly raise the convertible top well storage cover, arrow 1, and hold it.

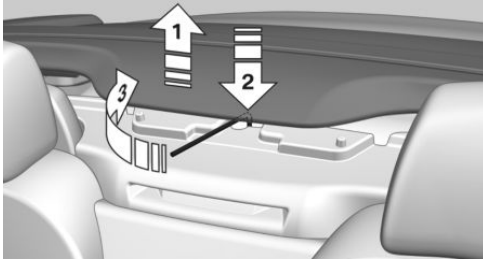

2. Insert the rear window tool through the funnel-shaped opening into the spindle, arrow 2. Turn the spindle clockwise, arrow 3, until the rear window is all the way down.

Lifting out convertible top



Only close the convertible top with two people

Carry out the following steps with the aid of a second person and with the doors open; otherwise, it may result in damage to the convertible top. ◀

1. Switch off the ignition.
2. Grasp the convertible top well storage cover on both sides, swing it up until it reaches its limit position and hold it in place.

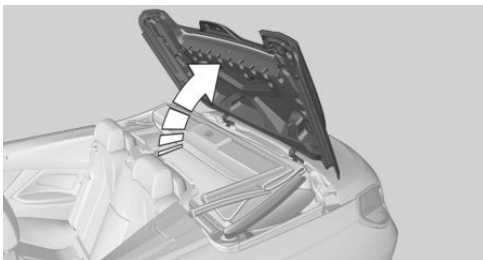

3. Remove the cover in the center of the front convertible top frame. If necessary, use a screwdriver to help with this.

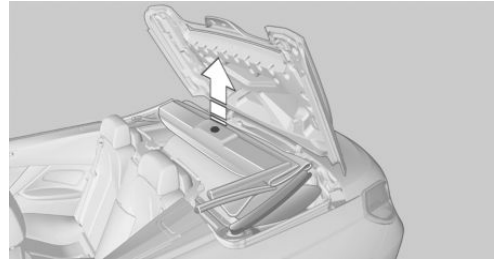

4. Insert the convertible top tool into the convertible top lock. Turn the convertible top tool approx. one half turn clockwise to open the convertible top lock. Be careful not to damage the convertible top fabric. Remove the convertible top tool.

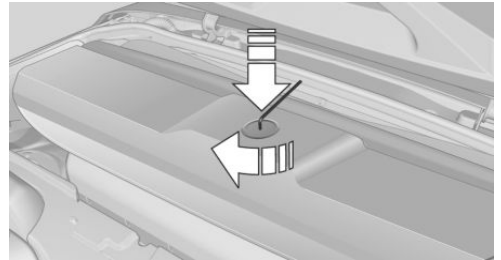

5. On both sides of the vehicle, grasp the front edge of the convertible top frame with one hand. With the other hand, grasp the end of the convertible top on the bottom edge. Keep the convertible top well storage cover open, e.g., with your shoulder.

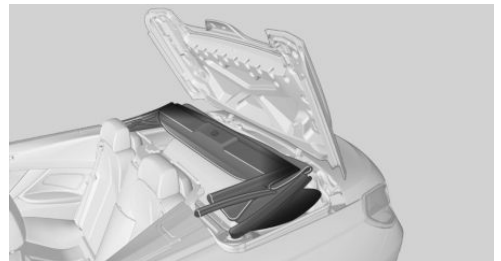

6. Lift out the convertible top and the convertible top ends on both sides simul-

taneously and swing it forward. When you do this, make sure that the convertible top ends do not push against other parts.

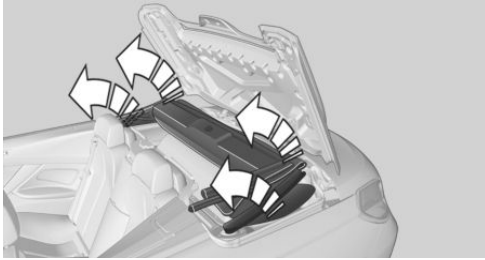

7. With the cover ends placed high, close the convertible top well storage cover.

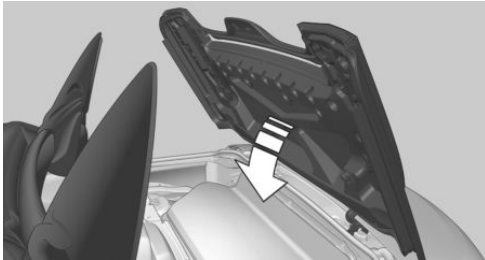

8. Fold down the two convertible top ends on the convertible top well storage cover.

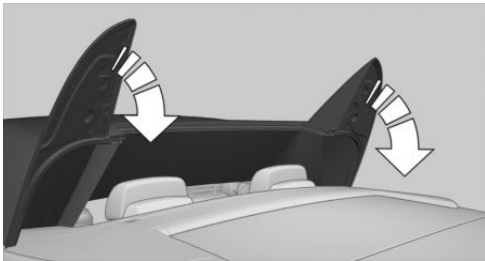

Lock convertible cover

1. Insert the cover tool on the front edge of the convertible top frame into the convertible top lock.
2. Turn the cover tool counterclockwise until the front convertible top frame is locked with the front windshield frame. Simultaneously, have a second person push from the

outside toward the center on the front windshield frame.

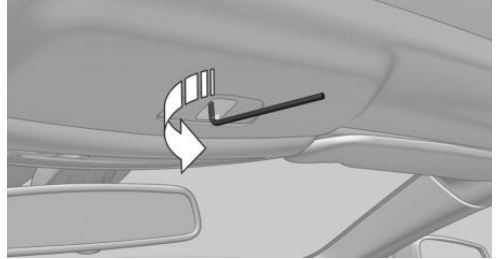

3. Insert the convertible top tool with the long end into the adapter from the onboard vehicle tool kit.
4. In the rear, raise the inner lining of the convertible top. Place the adapter on the red-marked pin of the convertible top mechanism.



5. Push the rear convertible top end down and simultaneously have a second person push the tool all the way up to the stop. In this way, the convertible top end is pushed against the convertible top well storage cover and locked.

Proceed accordingly on the other end of the convertible top.

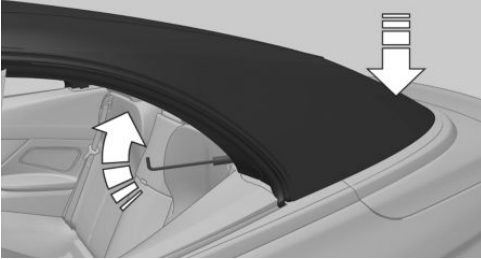

6. If possible, close the rear window electrically. To do this, switch on the ignition again. The rear window cannot be manually closed.
7. Have the convertible top checked by the service center.

Wind deflector

The concept

The wind deflector reduces the air movement in the passenger compartment when driving with the top down.

Installation

1. Remove wind deflector from the protective jacket and unfold it.

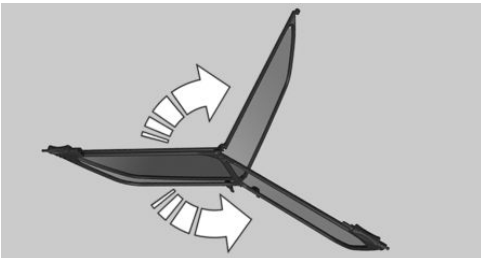

2. Press the upper and lower parts together until the latch engages.

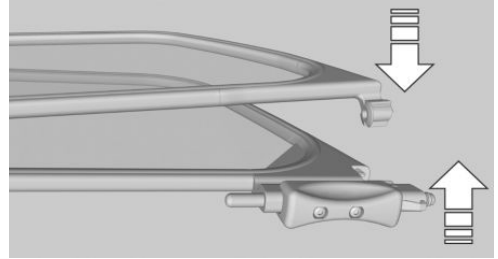

3. Push out the right retaining pin until the latch engages and flip out the two rear retaining pins.

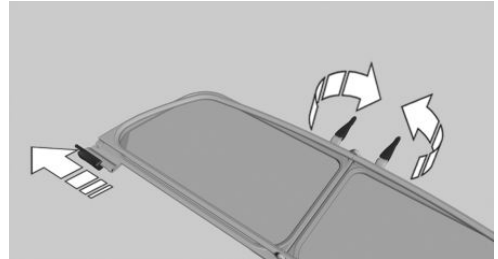

4. Install the wind deflector on the vehicle with the right retaining pin and the two rear ones in the corresponding openings.

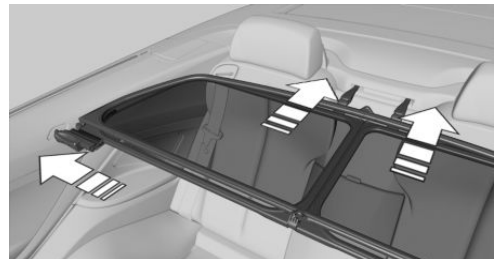

5. Push the left retaining pin into the provided opening until it latches.



6. Flip up the top half of the wind deflector.

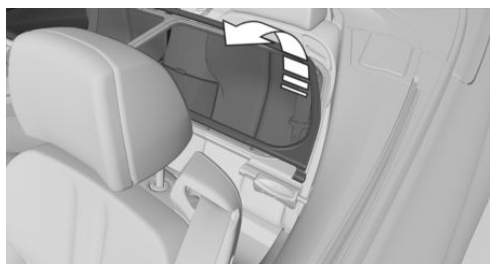

 Do not tilt the front seat backrest too far back

Do not tilt the front seat backrest too far back with the wind deflector installed if the seat is to be moved all the way back. Otherwise, the wind deflector will be damaged. ◀

Removing

Proceed in reverse sequence.

To release the two lateral retaining pins, pull the corresponding handle forward a little and then pull it to the side.

Folding up

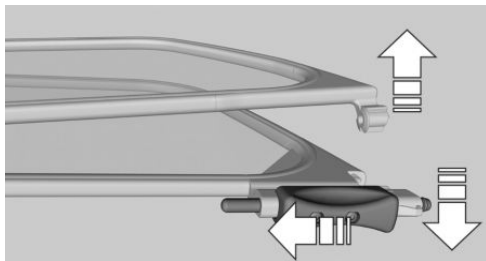

On the left side, pull the handle of the retaining pin on the wind deflector all the way back and release the latch. Fold in top and bottom part.

Adjusting

Vehicle equipment

All standard, country-specific and optional equipment that is offered in the model series is described in this chapter. Therefore, equipment is also described that is not available in a vehicle, e. g., because of the selected optional equipment or country variant. This also applies for safety-related functions and systems.

Sitting safely

The ideal seating position can make a vital contribution to relaxed, fatigue-free driving.

The seating position plays an important role in an accident in combination with:

- ▶ Safety belts, refer to page 54.
- ▶ Head restraints, refer to page 55.
- ▶ Airbags, refer to page 98.

Seats

Adjusting

General information

 Do not adjust the seat while driving
Do not adjust the driver's seat while driving, or the seat could respond with unexpected movement and the ensuing loss of vehicle control could lead to an accident. ◀

 Do not incline the backrest too far to the rear

Also on the front passenger side, do not incline the backrest on the front passenger side too far to the rear during driving, or there is a risk of slipping under the safety belt in the event of an accident. This would eliminate the protection normally provided by the belt. ◀

At a glance

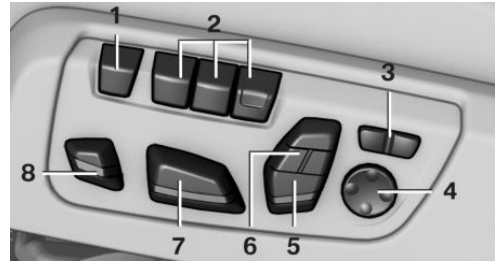

- 1 Active seat
- 2 Seat, mirror, and steering wheel memory
- 3 Backrest width
- 4 Lumbar support
- 5 Backrest, head restraint
- 6 Shoulder support
- 7 Forward/back, height, tilt
- 8 Thigh support

Note

The seat setting for the driver's seat is stored for the remote control currently in use. When the vehicle is unlocked via the remote control, the position is automatically retrieved if the Function, refer to page 40, for this is activated.

Adjustments in detail

1. Forward/back.

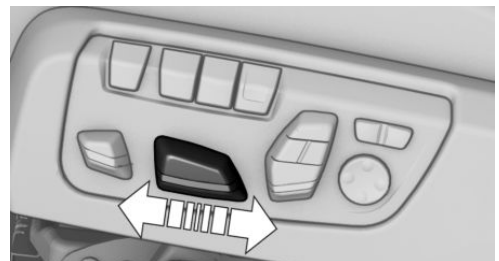

2. Height.

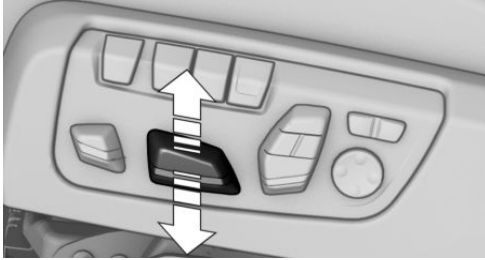

3. Seat tilt.

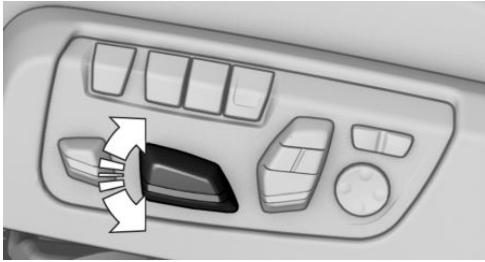

4. Backrest tilt.

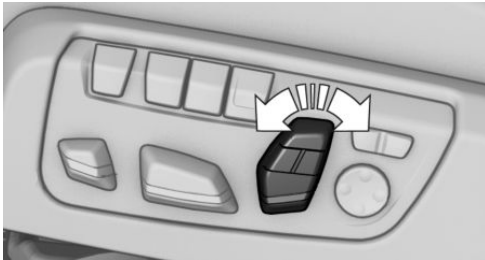

Thigh support

Multifunctional seat

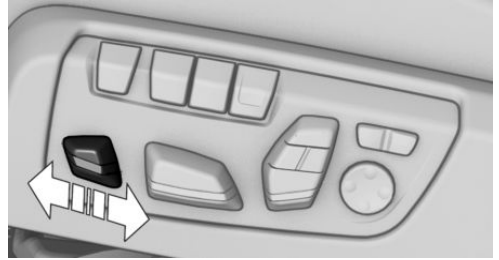

Adjust the position using the lever.

Lumbar support

The curvature of the seat backrest can be adjusted in such a way that it supports the lumbar region of the spine. The lower back and the spine are supported for upright posture.



- ▶ Press the front/rear section of the switch.
The curvature is increased/decreased.
- ▶ Press the upper/lower section of the switch.
The curvature is shifted up/down.

Backrest width



Change the width of the backrest using the side wings to adjust the lateral support.

To make it easier to enter and exit the vehicle, the backrest width temporarily opens fully.

Shoulder support

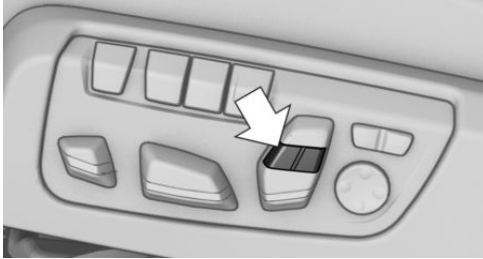

Also supports the back in the shoulder area:

- ▶ Results in a relaxed seating position.
- ▶ Reduces strain on the shoulder muscles.

Active seat

Active adjustment of the seat cushion's contours reduces muscular tension and fatigue to help prevent lower back pain.

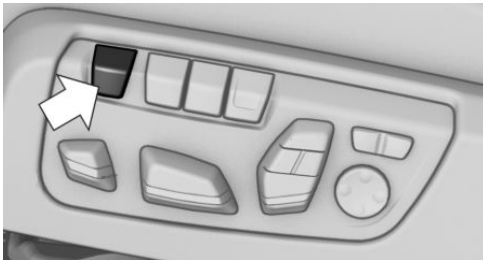

Press the button. The LED lights up.

Front seat heating



Switching on



Press the button once for each temperature level.

The maximum temperature is reached when three LEDs are lit.

If the drive is continued within approx. 15 minutes, the seat heating is activated automatically with the temperature selected last.

Switching off



Press the button longer.

The LEDs go out.

Temperature distribution

The heating action in the seat cushion and backrest can be distributed in different ways.

1. "Climate"
2. "Front seat heating"
3. Select the required seat.
4. Turn the controller to set the temperature distribution.

Active seat ventilation, front

The seat cushion and backrest surfaces are cooled by means of integrated fans.

The ventilation cools the seat, e. g., if the vehicle interior is overheated or for continuous cooling at high temperatures.



Switching on



Press the button once for each ventilation level.

The highest level is active when three LEDs are lit.

After a short time, the system automatically moves down one level in order to prevent excessive cooling.

Switching off



Press the button longer.

The LEDs go out.

Safety belts

Seats with safety belt

The vehicle has four seats, each of which is equipped with a safety belt.

Hints

Always make sure that safety belts are being worn by all occupants before driving away.

Although airbags enhance safety by providing added protection, they are not a substitute for safety belts.



One person per safety belt

Never allow more than one person to wear a single safety belt. Never allow infants or small children to ride on a passenger's lap. ◀



Putting on the belt

Lay the belt, without twisting, snugly across the lap and shoulders, as close to the body as possible. Make sure that the belt lies low around the hips in the lap area and does not press on the abdomen. Otherwise, the belt can slip over the hips in the lap area in a frontal impact and injure the abdomen.

The safety belt must not lie across the neck, rub on sharp edges, be routed over solid or breakable objects, or be pinched. ◀



Reduction of restraining effect

Avoid wearing clothing that prevents the belt from fitting properly, and pull the shoulder belt periodically to readjust the tension across your lap; otherwise, the retention effect of the safety belt may be reduced. ◀

Buckling the belt

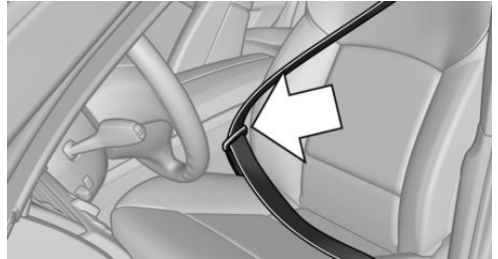

Make sure you hear the latch plate engage in the belt buckle.

Unbuckling the belt

1. Hold the belt firmly.
2. Press the red button in the belt buckle.
3. Guide the belt back into its reel.

Safety belt reminder for driver's and passenger's seat



The indicator lamp flashes or lights up and a signal sounds. Make sure that the safety belts are positioned correctly.

The safety belt reminder is active at speeds above approx. 5 mph/8 km/h. It can also be activated if objects are placed on the front passenger seat.

Damage to safety belts

In the case of strain caused by accidents or damage:

Have the safety belts, including the safety belt tensioners, replaced and have the belt anchors checked.



Checking and replacing safety belts

Have the work performed only by your service center; otherwise, it cannot be ensured that this safety feature will function properly. ◀

Front Head restraints

Correctly adjusted head restraint

A correctly adjusted head restraint reduces the risk of injury to cervical vertebrae in the event of an accident.



Adjusting the head restraint

Correctly adjust the head restraints of all occupied seats; otherwise, there is an increased risk of injury in an accident. ◀

Height

Adjust the head restraint so that its center is approximately at ear level.

Distance

Adjust the distance so that the head restraint is as close as possible to the back of the head.

Active head restraint

In the event of a rear-end collision with a certain severity, the active head restraint automatically reduces the distance from the head.



Reduced protective function

- ▶ Do not use seat or head restraint covers.
- ▶ Do not hang objects, e.g., clothes hangers, on the head restraints.
- ▶ Only attach accessories approved by BMW to the seat or head restraint.

Otherwise, the protective function of the active head restraint will be impaired and the personal safety of the occupants will be endangered. ◀

In the case of strain caused by accidents or damage:

Have the active headrest checked and if necessary replaced.

Adjusting the height

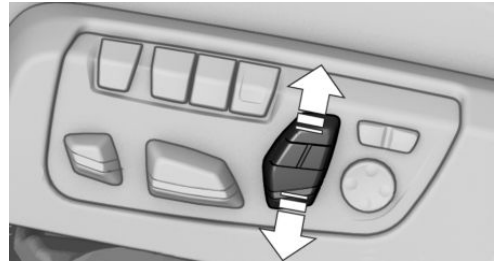

Adjusting electrically.

Distance to the back of the head



- ▶ Forward: pull.
- ▶ Back: press the button and push the head restraint toward the rear.

Adjusting the side extensions

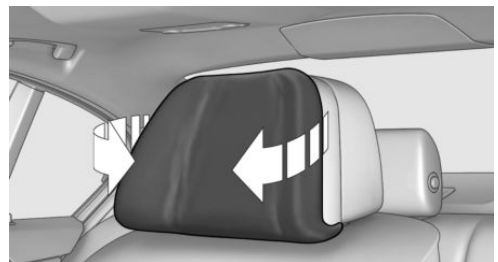

Fold forward for increased lateral support in the resting position.

Removing

The head restraints cannot be removed.

Entering the rear

Note

 Folding back and locking the backrest
Before driving away, fold back and lock the backrests; otherwise, an unexpected seat movement may cause an accident. ◀

Unlocking the backrest



1. Pull lever up to the stop.
2. Fold backrest forward.

Changing the seat position

Requirements

- ▷ Vehicle at a standstill.
- ▷ When the door is open, the seat is accessible from the side on which the door is open.

Controls

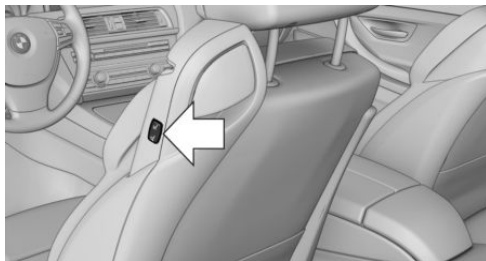

- ▷ Press and hold the button until the seat has moved to the desired position. Releasing the button stops the motion.
- ▷ Press the button briefly. The seat automatically moves to the respective end position. Pressing again stops the motion.

Folding back and locking the backrest

After entering the rear, fold the backrest back and lock it.



Press the button. The seat moves to its original position. Pressing again stops the motion.

Seat, mirror, and steering wheel memory

General information



Two different driver's seat, exterior mirror, and steering wheel positions can be stored and retrieved for each remote control. The adjustment of the lumbar support is not stored.

Storing

1. Switch on the ignition.
2. Set the desired position.
3.  Press the button. The LED in the button lights up.
4. Press the desired button 1 or 2. The LED goes out.

If the M button is pressed accidentally:

-  Press the button again.
The LED goes out.

Calling up settings

-  Do not retrieve the memory while driving
Do not retrieve the memory setting while driving, as an unexpected movement of the seat or steering wheel could result in an accident. ◀

Comfort function

1. Open the driver's door.
2. Switch off the ignition.
3. Briefly press the desired button 1 or 2.

The corresponding seat position is performed automatically.

The procedure stops when a switch for adjusting the seat or one of the buttons is pressed.

Safety mode

1. Close the driver's door or switch on the ignition.
2. Press and hold the desired button 1 or 2 until the adjustment procedure is completed.

Calling up of a seat position deactivated

After a brief period, the calling up of stored seat positions is deactivated to save battery power.

To reactivate calling up of a seat position:

- ▷ Open or close the door or trunk lid.
- ▷ Press a button on the remote control.
- ▷ Press the Start/Stop button.

Mirrors

Exterior mirrors

At a glance

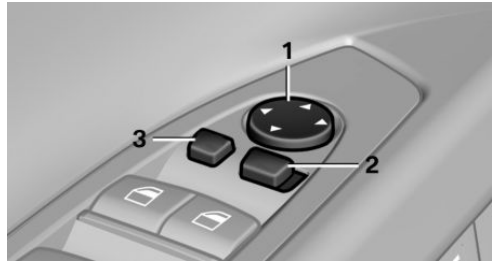

- 1 Adjusting
- 2 Left/right, Automatic Curb Monitor
- 3 Fold in and out

General information

The mirror on the passenger side is more curved than the driver's side mirror.

-  Estimating distances correctly
Objects reflected in the mirror are closer than they appear. Do not estimate the distance to the traffic behind you based on what you see in the mirror, as this will increase your risk of an accident. ◀

Depending on how the vehicle is equipped, the mirror setting is stored for the remote control in use. When the vehicle is unlocked via the remote control, the position is automatically retrieved if the setting for this function is active.

Selecting a mirror

-  To change over to the other mirror:
Slide the mirror changeover switch.

Adjusting electrically



The setting corresponds to the direction in which the button is pressed.

Saving positions

Seat, mirror, and steering wheel memory, refer to page 56.

Adjusting manually

If an electrical malfunction occurs, for example, press the edges of the mirror glass.

Automatic Curb Monitor

When the reverse gear is engaged, the mirror glass tilts downward slightly on the front passenger side. This improves your view of the curb and other low-lying obstacles when parking, for example.

Activating

1.  Slide the mirror changeover switch to the driver's side mirror position.
2. Engage transmission position R.

Deactivating

Slide the mirror changeover switch to the passenger's side mirror position.

Fold in and out

 Press the button.

Possible up to approx. 15 mph/20 km/h.

For example, this is advantageous

- ▷ In car washes.
- ▷ In narrow streets.
- ▷ For folding back mirrors that were folded away manually.

Mirrors that were folded in are folded out automatically at a speed of approx. 25 mph/40 km/h.



Fold in the mirror in a car wash

Before washing the car in an automatic car wash, fold in the exterior mirrors by hand or with the button; otherwise, the mirrors could be damaged, depending on the width of the vehicle. ◀

Automatic heating

Both exterior mirrors are automatically heated whenever the engine is running.

Automatic dimming feature

Both exterior mirrors are automatically dimmed. Photocells are used for control in the interior rear view mirror, refer to page 58.

Interior rearview mirror, automatic dimming feature

The concept

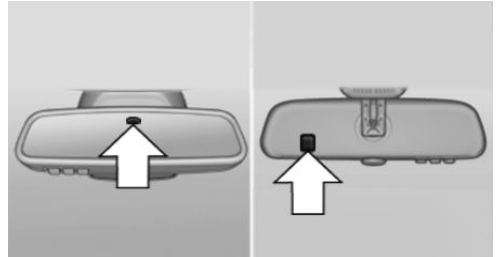

Photocells are used for control:

- ▷ In the mirror glass.
- ▷ On the back of the mirror.

Functional requirement

For proper operation:

- ▷ Keep the photocells clean.
- ▷ Do not cover the area between the inside rearview mirror and the windshield.

Steering wheel

General information



Do not adjust while driving

Do not adjust the steering wheel while driving; otherwise, an unexpected movement could result in an accident. ◀

Adjusting

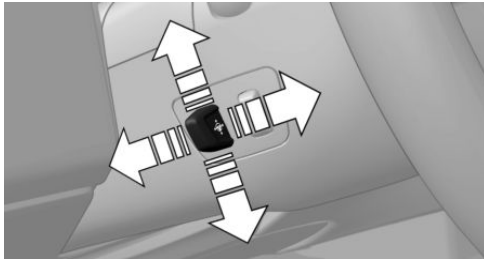

The steering wheel can be adjusted in four directions.

Storing the position

Seat, mirror, and steering wheel memory, refer to page 56.

Assistance getting in and out

The steering wheel temporarily moves into the highest position to make it easier to enter and exit the vehicle.

Steering wheel heating



Switching on/off



Press the button.

- ▷ On: the LED lights up.
- ▷ Off: the LED goes out.

M Drive

The concept

Individual settings can be carried out in two preassigned configurations for the vehicle.

When the engine is started, an efficient driving state is active by default. M Drive is deactivated.





At a glance

Configurations

The configurations are preassigned as follows:

- ▷ "M Drive 1": relaxed, comfortable driving.
- ▷ "M Drive 2": sporty, dynamic driving.

Setting options

Symbol	Meaning
	Dynamic Stability Control DSC, refer to page 119, and M Dynamic Mode MDM.
	Programs of M Engine Dynamics Control, refer to page 74.
	Programs of Electronic Damper Control EDC, refer to page 121.
	Programs of Servotronic, refer to page 122.

Symbol	Meaning
	M double-clutch transmission with Drivelogic, refer to page 70: shift modes and Drivelogic driving programs.
	Views of the Head-Up Display, refer to page 133.

Configuring M Drive

The preassigned configurations can be individually adjusted.

1. "Settings"
2. "M Drive 1" or "M Drive 2"
3. Select the desired setting option.
4. Select the desired channel.



The individual settings are stored for the remote control currently in use.

If M Drive is activated, a change in the setting on the Control Display is immediately adopted.

Activating/deactivating M Drive

Activating

Press the corresponding button on the steering wheel:

- ▷  Activate M Drive 1.
- ▷  Activate M Drive 2.

If DSC OFF or MDM is set in M Drive, a message appears in the instrument cluster. This message is confirmed by pressing the button again.

Deactivating

Press the corresponding button on the steering wheel.

Indicator lamps



- ▷ Indicator lamp comes on: corresponding M Drive is activated.
- ▷ Indicator lamp flashes: M Drive could not be activated. Antilock braking system ABS or Dynamic Stability Control DSC directly regulate the driving stability.
Reactivate M Drive if indicator lamp is no longer flashing.

Notes

If M Drive is activated, individual settings can also be modified outside of M Drive, e. g. using the buttons in the center console. This deactivates M Drive.

To reactivate all settings made for M Drive on the Control Display, briefly press one of the following buttons:



To adopt the changed settings in M Drive, press and hold the corresponding button.

Resetting M Drive

Individual settings can be reset to default values.

1. "Settings"
2. "M Drive 1" or "M Drive 2"
3. "Reset M Drive 1" or "Reset M Drive 2"
4. "Yes"

To cancel resetting: "No"

Transporting children safely

Vehicle equipment

All standard, country-specific and optional equipment that is offered in the model series is described in this chapter. Therefore, equipment is also described that is not available in a vehicle, e. g., because of the selected optional equipment or country variant. This also applies for safety-related functions and systems.

The right place for children

Note



Children in the vehicle

Do not leave children unattended in the vehicle; otherwise, they could endanger themselves and other persons, e.g., by opening the doors. ◀

Children should always be in the rear

Accident research shows that the safest place for children is in the back seat.



Transporting children in the rear

Only transport children younger than 13 years of age or shorter than 5 ft/150 cm in the rear in child restraint fixing systems provided in accordance with the age, weight and size of the child; otherwise, there is an increased risk of injury in an accident.

Children 13 years of age or older must wear a safety belt as soon as a suitable child restraint fixing system can no longer be used, due to their age, weight and size. ◀

Children on the front passenger seat

Should it ever be necessary to use a child restraint fixing system in the front passenger seat, make sure that the front, knee and side airbags on the front passenger side are deacti-

vated. Automatic deactivation of front passenger side airbags, refer to page 100.

Note



Deactivated front passenger airbags

If a child restraint fixing system is used in the front passenger seat, the front passenger airbags must be deactivated; otherwise, there is an increased risk of injury to the child when the airbags are triggered, even with a child restraint fixing system. ◀

Installing child restraint fixing systems

Hints



Manufacturer's information for child restraint fixing systems

To select, mount and use child restraint fixing systems, observe the information provided by the system manufacturer; otherwise, the protective effect can be impaired. ◀



Lock the rear seat backrests in position

Before installing a child restraint system, make sure that the rear seat backrests are locked; otherwise, the protective effect is not guaranteed and there is an increased risk of injury for the child in the event of an accident. ◀

On the front passenger seat

Deactivating airbags

After installing a child restraint fixing system in the front passenger seat, make sure that the front, knee and side airbags on the front passenger side are deactivated.

Deactivate the front passenger airbags automatically, refer to page 100.



Deactivating the front passenger airbags

If a child restraint fixing system is used in the front passenger seat, the front passenger airbags must be deactivated; otherwise, there is an increased risk of injury to the child when the airbags are triggered, even with a child restraint fixing system. ◀

Seat position and height

Before installing a child restraint fixing system, move the front passenger seat as far back as possible and adjust its height to the highest position to obtain the best possible position for the belt and to offer optimal protection in the event of an accident.

Do not change the seat position and height after this.

Backrest width

Adjustable backrest width: before installing a child restraint fixing system in the front passenger seat, open the backrest width completely. Do not change the backrest width again and do not call up a memory position.



Backrest width for the child seat

Before installing a child restraint fixing system in the front passenger seat, the backrest width must be opened completely. Do not change the adjustment after this; otherwise, the stability of the child seat will be reduced. ◀

Child seat security



The rear safety belts and the front passenger safety belt can be locked against pulling out for mounting the child restraint fixing systems.

Locking the safety belt

1. Pull out the belt webbing completely.
2. Secure the child restraint fixing system with the belt.
3. Allow the belt webbing to be pulled in and pull it taut against the child restraint fixing system. The safety belt is locked.

Unlocking the safety belt

1. Unbuckle the belt buckle.
2. Remove the child restraint fixing system.
3. Allow the belt webbing to be pulled in completely.

LATCH child restraint fixing system

LATCH: Lower Anchors and Tether for Children.

Note



Manufacturer's information for LATCH child restraint fixing systems

To mount and use the LATCH child restraint fixing systems, observe the operating and safety information from the system manufacturer; otherwise, the level of protection may be reduced. ◀

Mounts for the lower LATCH anchors

The lower anchors may be used to attach the CRS to the vehicle seat up to a combined child and CRS weight of 65 lb/30 kg when the child is restrained by the internal harnesses.

 Correctly engage the lower LATCH anchors

Make sure that the lower LATCH anchors have properly engaged and that the child restraint fixing system is resting snugly against the backrest; otherwise, the degree of protection offered may be reduced. ◀

Before mounting the LATCH child restraint fixing system, pull the belt away from the child restraint fixing system.

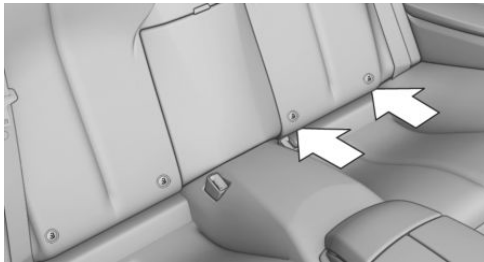

Mounts for the lower LATCH anchors are located in the gap between the seat and backrest.

Mounting ISOFIX child restraint fixing systems

1. Mount the child restraint fixing system; refer to the user's manual of the system.
2. Ensure that both LATCH anchors are properly connected.

Child restraint fixing system with a tether strap

For Canadian customers Only

The following statement is required by Transport Canada:

This vehicle is not equipped with user-ready tether anchorages. As such neither a child restraint system, nor a booster cushion, requiring the use of a tether strap can be properly secured in the vehicle.

Driving

Vehicle equipment

All standard, country-specific and optional equipment that is offered in the model series is described in this chapter. Therefore, equipment is also described that is not available in a vehicle, e. g., because of the selected optional equipment or country variant. This also applies for safety-related functions and systems.

Start/Stop button

The concept



Pressing the Start/Stop button switches the ignition on or off and starts the engine.

Double-clutch transmission:
The engine starts if the brake is

depressed while pressing the Start/Stop button.

Manual transmission: the engine starts if the clutch pedal is depressed when the Start/Stop button is pressed.

Ignition on

Double-clutch transmission: Press the Start/Stop button but do not depress the brake.

Manual-shift transmission: press the Start/Stop button, and do not press on the clutch pedal at the same time.

All vehicle systems are ready for operation.

Most of the indicator and warning lamps in the instrument cluster light up for varying lengths of time.

To save battery power when the engine is off, switch off the ignition and any unnecessary electronic systems/power consumers.

The ignition switches off automatically:

- ▷ When locking the vehicle, even if the low beams are switched on.
- ▷ Shortly before the battery is discharged completely, so that the engine can still be started.

Note

If the engine is switched off and the ignition is switched on, the system automatically switches to the radio ready state when the door is opened if the lights are switched off or the daytime running lights are switched on.

Ignition off

Double-clutch transmission: Press the Start/Stop button again, but do not depress the brake.

Manual-shift transmission: press the Start/Stop button again, and do not press on the clutch pedal at the same time.

All indicator lamps in the instrument cluster go out.

To save battery power when the engine is off, switch off the ignition and any unnecessary electronic systems/power consumers.

 Transmission position P with the ignition off

When the ignition is switched off, position P is engaged automatically. When in an automatic car wash, for example, ensure that the ignition is not switched off accidentally. ◀

The ignition automatically cuts off while the vehicle is stationary and the engine is stopped:

- ▷ When locking the vehicle, and when the low beams are activated.
- ▷ Shortly before the battery is discharged completely, so that the engine can still be started. This function is only available when the low beams are switched off.

- ▷ When opening or closing the driver door, if the driver's seat belt is unbuckled and the low beams are switched off.
- ▷ While the driver's seat belt is unbuckled, if the driver's door is open and the low beams are switched off.

When the ignition is switched off, by opening or closing the driver's door or unbuckling the driver's seat belt, the radio ready state remains active.

Radio ready state

Activate radio ready state:

- ▷ When the engine is running: press the Start/Stop button.

Some electronic systems/power consumers remain ready for operation.

The radio ready state switches off automatically:

- ▷ After approx. 8 minutes.
- ▷ When the vehicle is locked using the central locking system.
- ▷ Shortly before the battery is discharged completely, so that the engine can still be started.

Starting the engine

Hints



Enclosed areas

Do not let the engine run in enclosed areas; otherwise, breathing of exhaust fumes may lead to loss of consciousness and death. The exhaust gases contain carbon monoxide, an odorless and colorless but highly toxic gas. ◀



Unattended vehicle

Do not leave the vehicle unattended with the engine running; doing so poses a risk of danger.

Before leaving the vehicle with the engine running, set the parking brake and engage transmission position P; otherwise, the vehicle may begin to roll. ◀



Repeated starting in quick succession

Avoid repeated unsuccessful attempts to start the vehicle or starting the vehicle several times in quick succession. Otherwise, the fuel is not burned or is inadequately burned, posing a risk of overheating and damage to the catalytic converter. ◀

Do not wait for the engine to warm-up while the vehicle remains stationary. Start driving at moderate engine speeds.

Manual transmission

Starting the engine

1. Depress the brake pedal.
2. Press on the clutch pedal and shift to neutral.
3. Press the Start/Stop button.

The ignition is activated automatically for a certain time and is stopped as soon as the engine starts.

Double-clutch transmission

Starting the engine

1. Depress the brake pedal.
2. Press the Start/Stop button.

The ignition is activated automatically for a certain time and is stopped as soon as the engine starts.

Engine stop

Hints

 Take the remote control with you when leaving the vehicle so that children, for example, cannot start the engine. ◀

 Set the parking brake and further secure the vehicle as required

Set the parking brake firmly when parking; otherwise, the vehicle could roll. On steep upward and downward inclines, further secure the vehicle, for example, by turning the steering wheel in the direction of the curb. ◀

Before driving into a car wash

In order for the vehicle to be able to roll into a car wash, heed the information regarding Washing in automatic car washes, refer to page 196.

Manual transmission

Switching off the engine

1. With the vehicle at a standstill, press the Start/Stop button.
2. Shift into first gear or reverse.
3. Set the parking brake.

Double-clutch transmission

Switching off the engine

1. Apply the brakes until the vehicle comes to a stop.
2. Press the Start/Stop button.
The engine is switched off.
The radio ready state is switched on.
3. Set the parking brake.

Automatic Engine Start/Stop Function

The concept

The Auto Start/Stop function helps save fuel. The system switches off the engine during a stop, e.g., in a traffic congestion or at traffic lights. The ignition remains switched on. The engine starts again automatically for driving off.

Certain vehicle components may experience additional wear as a result of this system.

Semi-automatic mode

After every start of the engine, the Auto Start Stop function is in the last selected state, refer to page 68. When the Auto Start Stop function is active, it is available when the vehicle is traveling faster than about 3 mph, approx. 5 km/h.

Engine stop

The engine is switched off automatically during a stop under the following conditions:

Double-clutch transmission:

- ▶ The selector lever is in transmission position D.
- ▶ Brake pedal remains depressed while the vehicle is stopped.
- ▶ The driver's seat belt is buckled or the driver's door is closed.

The air volume of the air conditioner is reduced when the engine is switched off.

Displays in the instrument cluster



The display indicates that the automatic engine start-stop function is ready for an automatic engine start.



The display indicates that the conditions for an automatic engine stop have not been satisfied.

Note

The engine is not switched off automatically in the following situations:

- ▷ External temperature too low.
- ▷ The external temperature is high and automatic climate control is running.
- ▷ The passenger compartment has not yet been heated or cooled to the required level.
- ▷ The engine is not yet at operating temperature.
- ▷ The wheels are at a sharp angle or the steering wheel is being turned.
- ▷ After driving in reverse.
- ▷ Fogging of the windows when the automatic climate control is switched on.
- ▷ Vehicle battery is heavily discharged.
- ▷ The engine compartment lid is unlocked.
- ▷ Stop-and-go traffic.
- ▷ Use of fuel with high ethanol content.

Starting the engine

The engine starts automatically under the following conditions:

- ▷ Manual transmission:
The clutch pedal is pressed.
- ▷ Double-clutch transmission:
By releasing the brake pedal.

After the engine starts, accelerate as usual.

Safety mode

After the engine switches off automatically, it will not start again automatically if any one of the following conditions are met.

- ▷ The driver's safety belt is unbuckled and the driver's door is open.
- ▷ The hood was unlocked.

Some indicator lamps light up for varying lengths of time.

The engine can only be started via the Start/Stop button.

Note

Even if driving away was not intended, the deactivated engine starts up automatically in the following situations:

- ▷ Excessive warming of the passenger compartment when the cooling function is switched on.
- ▷ The steering wheel is turned.
- ▷ Double-clutch transmission: Change of the transmission from D to N, R or D/S.
- ▷ Double-clutch transmission: Accelerating while simultaneously applying the brake.
- ▷ Fogging of the windows when the automatic climate control is switched on.
- ▷ Vehicle battery is heavily discharged.
- ▷ Excessive cooling of the passenger compartment when the heating is switched on.

Preventing an automatic engine stop with a double-clutch transmission

The concept

To make it possible to drive away very quickly, such as at an intersection, the automatic engine stop can be actively prevented.

Preventing an engine stop using the brake pedal

The engine stop can be actively prevented within one second after the vehicle comes to a standstill.

- ▷ Immediately after the vehicle comes to a standstill, briefly press the brake pedal forcefully.

- ▶ Then press the brake pedal with normal braking force.

Activating/deactivating the system manually

Using the button



Press the button.

- ▶ LED comes on: Auto Start Stop function is deactivated.
The engine is started during an automatic engine stop.
The engine can only be stopped or started via the Start/Stop button.
- ▶ LED goes out: Auto Start Stop function is activated.

Switching off the vehicle during an automatic engine stop

During an automatic engine stop, the vehicle can be switched off permanently, e.g., when leaving it.

1. Press the Start/Stop button. The ignition is switched off. The Auto Start/Stop function is deactivated.
Transmission position P is engaged automatically.
2. Set the parking brake.
Engine start as usual via Start/Stop button.

Automatic deactivation

In certain situations, the Auto Start/Stop function is deactivated automatically for safety reasons, such as when the driver is detected to be absent.

Malfunction

The Auto Start/Stop function no longer switches of the engine automatically. A Check Control message is displayed. It is possible to continue driving. Have the system checked.

Parking brake

The concept

The parking brake is used to prevent the vehicle from rolling when it is parked.



Setting



Pull the switch.

The LED lights up.



The indicator lamp lights up red. The parking brake is set.



Lower lamp: indicator lamp in Canadian models



Set the parking brake and further secure the vehicle as required

Set the parking brake firmly when parking; otherwise, the vehicle could roll. On steep upward and downward inclines, further secure the ve-

hicle, for example, by turning the steering wheel in the direction of the curb. ◀

While driving

Use while driving serves as an emergency braking function:

Pull the switch and hold it. The vehicle brakes hard while the switch is being pulled.

 The indicator lamp lights up red, a signal sounds and the brake lamps light up.

 Lower lamp: indicator lamp in Canadian models.

If the vehicle is braked to a speed of approx. 2 mph/3 km/h, the parking brake remains set.

Releasing

With the ignition switched on:

 Manual transmission: Press the switch while the brake or clutch pedal is pressed.

Double-clutch transmission: Press the switch while pressing on the brake pedal.

The LED and indicator lamp go out.

The parking brake is released.

Automatic Release

For automatic release, operate the accelerator pedal.

The LED and indicator lamp go out.

Subject to the following requirements, the parking brake is automatically released by operation of the accelerator pedal:

- ▷ Engine on.
- ▷ Drive position engaged.
- ▷ Driver buckled in and doors closed.

 Inadvertent operation of the accelerator pedal

Make sure that the accelerator pedal is not operated unintentionally; otherwise, the vehicle is

set in motion and there is a risk of an accident. ◀

Automatic release for manual transmission

Drive off as usual. The parking brake disengages when the clutch pedal is released.

The LED and indicator lamp go out.

Under the following conditions, the parking brake is automatically released:

- ▷ Engine on.
- ▷ Gear engaged.
- ▷ Driver buckled in and doors closed.
- ▷ Engine power is sufficient to drive off.

 Inadvertent operation of the clutch pedal
Make sure that the clutch pedal is not operated unintentionally; otherwise, the vehicle is set in motion when the clutch is released, and there is a risk of an accident. ◀

Malfunction

In the event of a failure or malfunction of the parking brake, secure the vehicle against rolling using a wheel chock, for example, when leaving it.

After a power failure

 Only put the parking brake into operation after a power failure

The parking brake should only be put into operation again if it was manually released due to an interruption in the supply of electrical power. Otherwise, it cannot be ensured that the parking brake will function properly. ◀

Putting the parking brake into operation

1. Switch on the ignition.
2.  Press the switch while the brake is depressed or transmission position P is engaged.

It may take several seconds for the brake to be put into operation. Any sounds associated with this are normal.

PARK

The indicator lamp in the instrument cluster goes out as soon as the parking brake is ready for operation.

(P)

Lower lamp: indicator lamp in Canadian models.

M double-clutch transmission with Drivelogic

The concept

The M double-clutch transmission with Drivelogic is an automatic shift transmission with two clutches and partial transmissions in which the gears can be changed without interrupting the tractive force.

The operation is via the shift lever or two shift paddles on the steering wheel.

Functions

- ▷ Sequential mode or drive mode.
- ▷ Various drive programs, Drivelogic.
- ▷ Upshifting display, Shift Lights.
- ▷ Automatic downshifting and protection from misshifting even in sequential mode.
- ▷ Launch Control.
- ▷ Automatic double-clutching.
- ▷ Low Speed Assistant.

Selector lever, transmission positions

At a glance



- ▷ R: reverse gear.
- ▷ N: neutral.
- ▷  Center position, forward position.
- ▷ +: manual upshifting.
- ▷ -: manual downshifting.
- ▷ D/S: switch between drive mode and sequential mode.

Engaging the transmission position

Pull or push lever in the corresponding direction.

As soon as the selector lever is released, it reverts to the center position. In position R, the selector lever locks.

The engaged transmission position is displayed in the instrument cluster and on the selector lever.

With the transmission position engaged, the vehicle can be moved very slowly when maneuvering or in stop and go traffic. To do this, depress the accelerator briefly while the vehicle is stationary.

Shift lock

To shift out of neutral, apply the brake while the vehicle is stationary.

R is Reverse

Select only when the vehicle is stationary.

It is also possible to rock the vehicle up to 6 mph/10 km/h. To do this, switch between forward and reverse gear.

N is Neutral

Use in automatic car washes, for example. The vehicle can then roll.

S Sequential mode

Use the shift paddles or the shift lever to up-shift or downshift without letting off the gas.

Automatic Functions:

- ▶ Upshifting or downshifting is done only if the rpm and vehicle speed are appropriate.

For example, there is no downshifting if the engine speed is too high.

- ▶ Shortly before falling below a gear-dependent minimum speed, the transmission is automatically downshifted.

It is also possible to start out in 2nd gear, e. g. on icy roads.

Kickdown: for maximum acceleration, e. g. when passing. To do this, depress the accelerator pedal past the resistance point, and pull the left shift paddle once or push the shift lever forward once.

Switch to Drive mode: push selector lever in D/S direction.

D Drive mode

In Drive mode, all forward gears are automatically changed.

Kickdown: for maximum acceleration, e. g. when passing. To do this, depress the accelerator pedal past the resistance point.

Switch to Sequential mode: shift using the shift paddles or the selector lever, or push the selector lever in the D/S direction.

P Park

The drive wheels are blocked.

P is engaged automatically:

- ▶ After the engine is switched off in ignition off, refer to page 64, if position R or D is engaged.
- ▶ If the ignition is switched off and position N is engaged.

Displays in the instrument cluster

Sequential mode



- ▶ Engaged gear, arrow 1.
- ▶ Selected driving program, Drivelogic, refer to page 72, arrow 2.

Drive mode

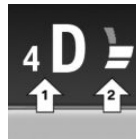

- ▶ Engaged gear together with a D, arrow 1.
- ▶ Selected driving program, Drivelogic, refer to page 72, arrow 2.

Note

When the external temperature is very low, the display may not work. Current driving direction is recognizable at the engaged selector lever position.

Gear change

Shifting in Sequential mode possible.

A shift in Drive mode causes a switch to Sequential mode.

Using the selector lever

- ▶ To shift up: pull the selector lever rearwards.
- ▶ To shift down: press the selector lever forward.

Using the shift paddles on the steering wheel

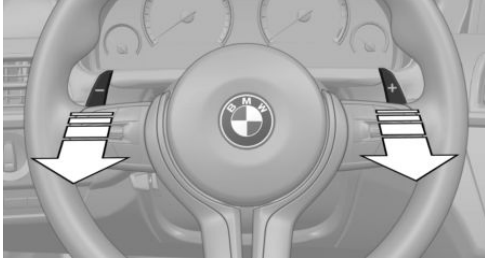

- ▷ Shift up: pull right shift paddle.
- ▷ Shift down: pull left shift paddle.

Drivelogic

Various driving programs are available.

After each switch between Sequential mode and Drive mode, the last program selected is an active.

Exception: after each engine start, driving program 1 is active in Drive mode.

In Drive mode

Choice of three driving programs:

- ▷ 1: efficient driving.
- ▷ 2: relaxed driving.
- ▷ 3: sporty driving.

In Sequential mode

Choice of three driving programs:

- ▷ 1: comfortable shifting operations.
- ▷ 2: sporty, fast shifting operations.
- ▷ 3: maximum shifting speed, Launch Control, refer to page 73.

Selecting driving program using rocker switch in center console



 Press button repeatedly until the desired driving program is displayed in the instrument cluster.

Selecting driving program using M Drive

1. Switch on the ignition.
2. "Settings"
3. "M Drive 1" or "M Drive 2"
4.  Select the symbol.
5. "Mode"
6. Turn the controller until the desired setting is reached and press the controller.
 - ▷ "D": drive mode
 - ▷ "S": sequential mode.
7. "Shift position"
8. Turn the controller until the desired setting is reached and press the controller.
9. Selecting another driving program.

When M Drive is active, setting is immediately applied.

To activate M Drive with the selected settings, press the corresponding button on the steering wheel:

- ▷ 
- ▷ 



Risk of an accident

Use the settings for DSC in M Drive; otherwise, driving stability may be impaired, and there is risk of an accident. ◀

Display in the instrument cluster



Selected driving program corresponds to the number of illuminated fields.

Launch Control

The concept

Launch Control enables optimum acceleration on surfaces with good traction.



Component wear

Do not use Launch Control too often; otherwise, this may result in premature wear of components due to the high stress placed on the vehicle. ◀

Activate Launch Control

Launch Control is available when the engine is warmed up, that is, after uninterrupted driving of at least 6 miles/10 km.

1. Deactivate Dynamic Stability Control, refer to page 120.
2. Select Sequential mode with driving program 3.
3. With the engine running, lightly apply the brakes with the left foot.
4. While the vehicle is stationary, press the selector lever forward and hold it.
A flag symbol appears in the instrument cluster.
5. Fully depress the accelerator pedal.
The starting engine speed adjusts.

6. If necessary, change the starting engine speed by 500 rpm via cruise control.
7. Release brake. When the selector lever is released, the vehicle accelerates. Keep the accelerator pedal depressed.

Upshifting occurs automatically as long as the accelerator pedal is fully depressed.

Hints

Launch Control is available only after a certain distance has been driven.

Did not use Launch Control during the break-in, refer to page 154, period.

To maintain driving stability, always activate DSC if possible.

Shift Lights

The concept

Shift Lights in the Head-Up Display indicate the optimum shifting point in Sequential mode, refer to page 71. Thus, with a sporty driving style, the best possible vehicle acceleration is achieved.

Display in the Head-up Display

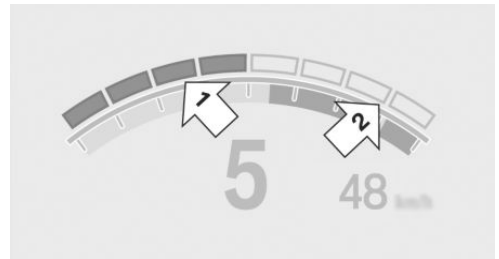

- ▷ Current engine speed is lightly highlighted in the display.
- ▷ Arrow 1: successive yellow illuminated fields indicate the upcoming upshift moment.
- ▷ Arrow 2: fields are illuminated in red. Do not wait any further to shift.

When the maximum possible speed is reached, the entire speed display flashes.

When the maximum speed is exceeded, the supply of fuel is interrupted in order to protect the engine. Speeds in this range must be avoided.

Displaying Shift Lights

Shift Lights can only be displayed in M view, refer to page 134.

1. Switch on Head-Up Display, refer to page 134.
2. "Settings"
3. "Head-Up Display"
4. "Displayed information"
5. "M View"

Low Speed Assistant

The Low Speed Assistant gives assistance at very low speeds. The vehicle travels at walking speed and automatically controls the speed of the engine.

This can also be used for rocking the vehicle in the snow. To do this, switch between reverse gear and forward gear without stepping on the brakes in the process.

Activating

1. Engage a driving position.
2. Briefly tap the accelerator pedal.

The vehicle rolls at minimum speed.

This is possible in 1st and 2nd gear and in reverse gear.



Overheating

Do not ride the brake; otherwise, the transmission may overheat. ◀

Deactivating

Apply the brakes until the vehicle comes to a stop.

System limits

This transmission has an overheating protection mechanism, which protects the clutch from extreme stress.



- ▶ Indicator lamp lights up yellow: transmission too hot.
Avoid high engine stress and frequent starts.
- ▶ Indicator lamp lights up red: transmission is overheating.
Further driving at a moderate pace is possible. At the next opportunity, stop the car, shut off the engine and allow the transmission to cool down.

Avoid fast starts, and on inclines did not accelerate lightly while letting the clutch slip; otherwise, the transmission may overheat.

During traffic jams or at very low speeds, use the Low Speed Assistant, refer to page 74.

M Driving Dynamics Control

The concept

The M Driving Dynamics Control affects the response of the vehicle to accelerator pedal movements.

Programs

Response behavior options:

- ▶ "Efficient": comfortable. Minimal fuel consumption.
Ideal e. g. in city traffic or on snow.
- ▶ "Sport": sporty, dynamic.
- ▶ "Sport Plus": spontaneous, direct. Maximum dynamics.

Selecting a channel

Via M Drive

1. "Settings"
2. "M Drive 1" or "M Drive 2"
3.  Select the symbol.
4. Select the desired channel.

When M Drive is active, setting is immediately applied.

To activate M Drive with the selected settings, press the corresponding button on the steering wheel:



Using the button



 Press button repeatedly until the desired program is displayed in the instrument cluster.

Display in the instrument cluster

 Engine Dynamics Control with selected program with activated Display of the system states of the driving dynamics, refer to page [85](#).

Turn signal, high beams, headlamp flasher

Turn signal

Using turn signals

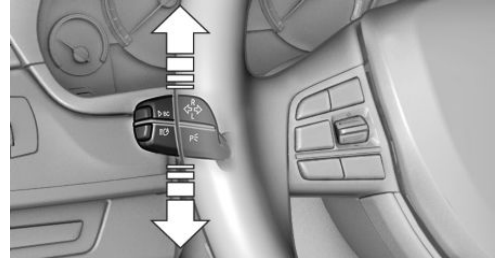

Press the lever beyond the resistance point.
To switch off manually, press the lever to the resistance point.

Unusually rapid flashing of the indicator lamp indicates that a turn signal bulb has failed.

Triple turn signal activation

Press the lever to the resistance point.

The turn signal flashes three times.

The function can be activated or deactivated:

1. "Settings"
2. "Lighting"
3. "Triple turn signal"

Signaling briefly

Press the lever to the resistance point and hold it there for as long as you want the turn signal to flash.

High beams, headlamp flasher

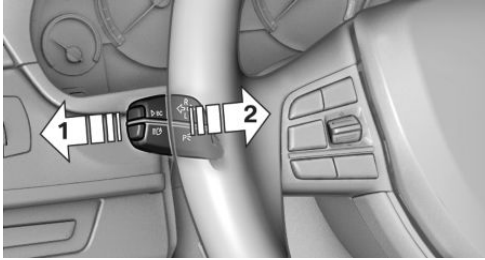

- ▷ High beams, arrow 1.
- ▷ Headlamp flasher, arrow 2.

Washer/wiper system

Switching the wipers on/off and brief wipe



Do not switch on the wipers if frozen

Do not switch on the wipers if they are frozen onto the windshield; otherwise, the wiper blades and the windshield wiper motor may be damaged. ◀



No wiper operation on dry windshield

Do not use the windshield wipers if the windshield is dry, as this may damage the wiper blades or cause them to become worn more quickly. ◀

Switching on

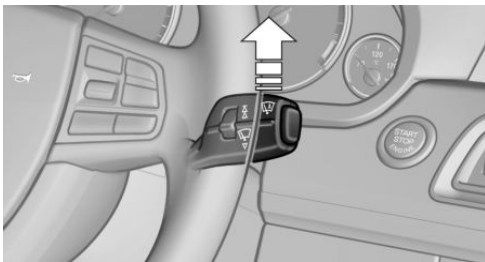

Press the wiper levers up.

The lever automatically returns to its initial position when released.

- ▷ Normal wiping speed: press up once.

The wipers switch to intermittent operation when the vehicle is stationary.

- ▷ Fast wiping speed: press up twice or press once beyond the resistance point.

The wipers switch to normal speed when the vehicle is stationary.

Switching off and brief wipe

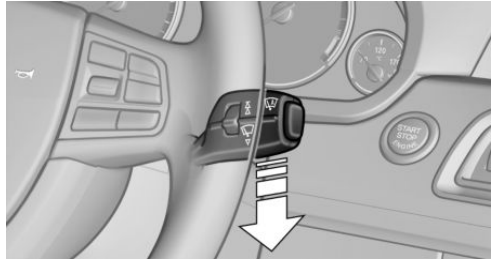

Press the wiper levers down.

The lever automatically returns to its initial position when released.

- ▷ Brief wipe: press down once.
- ▷ To switch off normal wipe: press down once.
- ▷ To switch off fast wipe: press down twice.

Rain sensor

The concept

The rain sensor automatically controls the time between wipes depending on the intensity of the rainfall. The sensor is located on the windshield, directly behind the interior rearview mirror.

Activating/deactivating

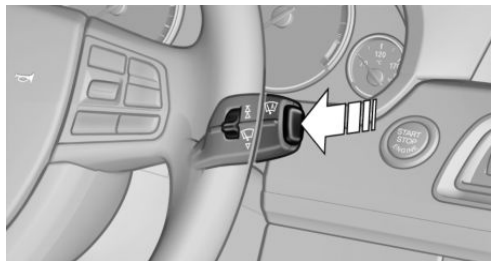

Press the button on the wiper lever.

The LED in the wiper lever lights up and a wiping operation is started. At temperatures below 32 °F/0 °C, a wiping operation is not started.

! Deactivate the rain sensor in car washes
Deactivate the rain sensor when passing through an automatic car wash; otherwise, damage could be caused by undesired wiper activation. ◀

Rain sensor, sensitivity

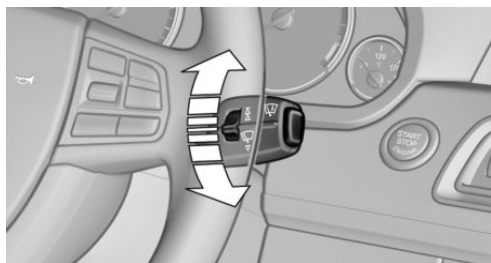

Turn the thumbwheel.

Clean the windshield, headlamps

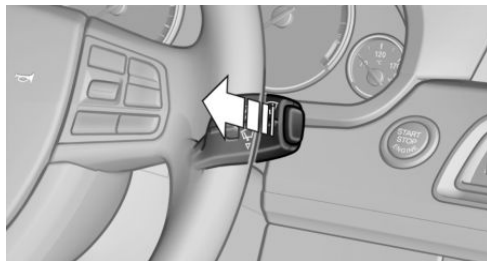

Pull the wiper lever.

The system sprays washer fluid on the windshield and activates the wipers briefly.

In addition, the headlamps are cleaned at regular intervals when the vehicle lights are switched on.

! Do not use the washer system at freezing temperatures

Do not use the washers if there is any danger that the fluid will freeze on the windshield; otherwise, your vision could be obscured. For this reason, use antifreeze.

Avoid using the washer when the reservoir is empty; otherwise, you could damage the pump. ◀

Windshield washer nozzles

The windshield washer nozzles are automatically heated while the ignition is switched on.

Fold-out position of the wipers

Required when changing the wiper blades or under frosty conditions, for example.

1. Switch the ignition on and off again.
2. Under frosty conditions, ensure that the wiper blades are not frozen onto the windshield.
3. Press the wiper lever up beyond the point of resistance and hold it for approx. 3 seconds, until the wiper remains in a nearly vertical position.

After the wipers are folded back down, the wiper system must be reactivated.



Fold the wipers back down

Before switching the ignition on, fold the wipers back down to the windshield; otherwise, the wipers may become damaged when they are switched on. ◀

1. Switch on the ignition.
2. Press the wiper levers down. The wipers move to their resting position and are ready for operation.

Washer fluid

General information



Antifreeze for washer fluid

Antifreeze is flammable and can cause injury if it is used incorrectly.

Therefore, keep it away from sources of ignition.

Only keep it in the closed original container and inaccessible to children.

Follow the notes and instructions on the container.

United States: The washer fluid mixture ratio is regulated by the U.S. EPA and many individual states; do not exceed the allowable washer fluid dilution ratios limits that apply. Follow the usage instructions on the washer fluid container. Use BMW's Windshield Washer Concentrate or the equivalent. ◀

Washer fluid reservoir



Adding washer fluid

Only add washer fluid when the engine is cool, and then close the cover completely to avoid contact between the washer fluid and hot engine parts.

Otherwise, there is the danger of fire and a risk to personal safety if the fluid is spilled. ◀

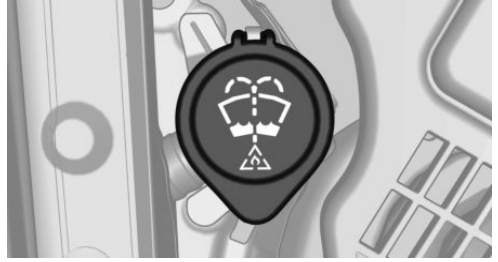

All washer nozzles are supplied from one reservoir.

Fill with a mixture of windshield washer concentrate and tap water and – if required – with a washer antifreeze, according to the manufacturer's recommendations.

Mix the washer fluid before adding to maintain the correct mixing ratio.

Do not add windshield washer concentrate and antifreeze undiluted and do not fill with pure water; this could damage the wiper system.

Do not mix window washer concentrates of different manufacturers, because otherwise it can result in clogging of the windshield washer nozzles.

For the capacity, refer to technical data.

Displays

Vehicle equipment

All standard, country-specific and optional equipment that is offered in the model series is described in this chapter. Therefore, equip-

ment is also described that is not available in a vehicle, e. g., because of the selected optional equipment or country variant. This also applies for safety-related functions and systems.

Instrument cluster

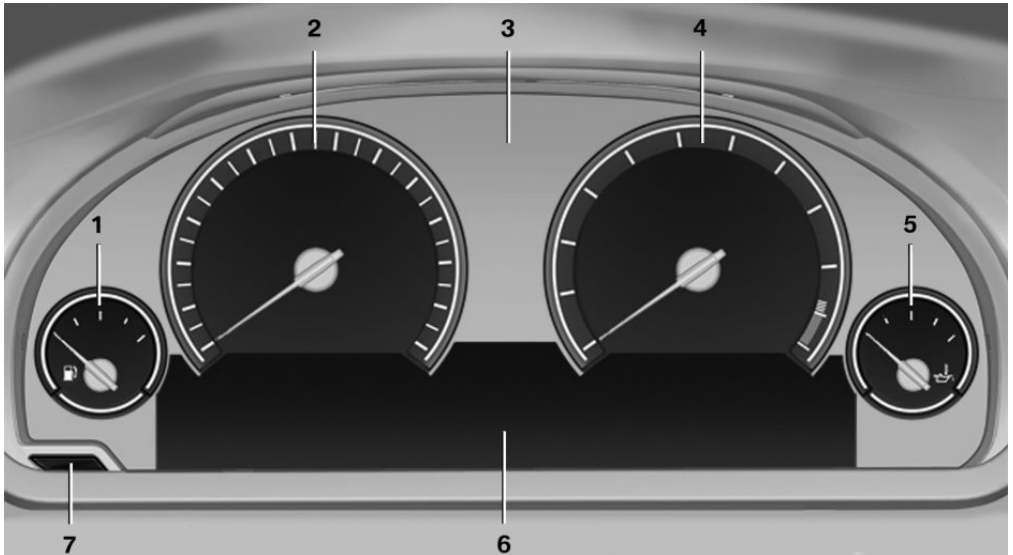

- | | |
|--|--|
| 1 Fuel gauge 82 | 5 Oil temperature 82 |
| 2 Speedometer | 6 Electronic displays 80 |
| 3 Indicator/warning lamps 80 | 7 Reset miles 83 |
| 4 Tachometer 82 | |

Electronic displays

Overview, instrument cluster

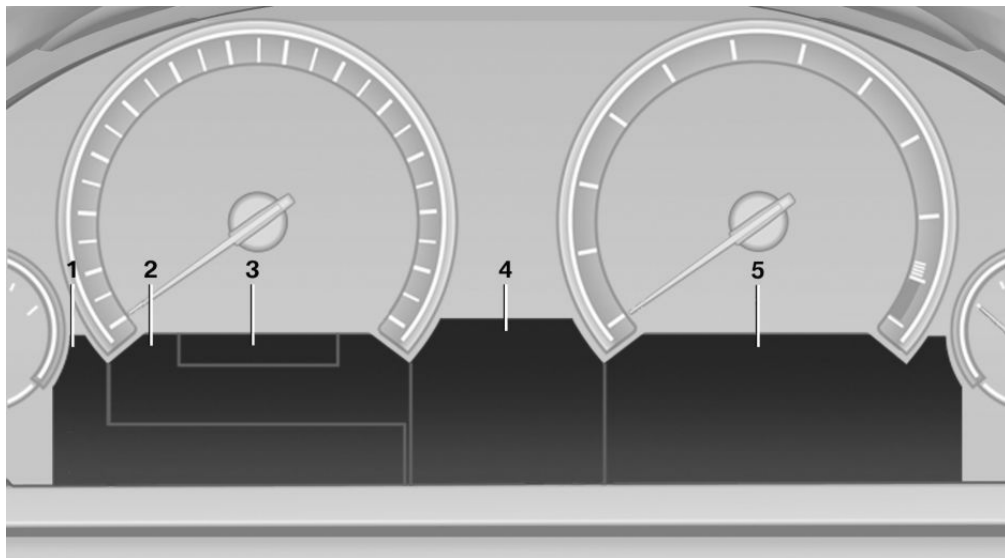

1 Messages, e.g. Check Control 80

Time 83

Digital tachometer 83

2 Range 84

3 Computer 89

4 Transmission display, Drivelogic 84

Gear shift indicator 86

Service requirements 85

Miles/trip miles 83

5 Selection list, such as for the radio 88

System states of driving dynamics 85

Current fuel consumption 84

Energy recovery 84

External temperature 83

Auto Start/Stop function 66

Check Control

The concept

The Check Control system monitors functions in the vehicle and notifies you of malfunctions in the monitored systems.

A Check Control message is displayed as a combination of indicator or warning lamps and text messages in the instrument cluster and in the Head-up Display.















In addition, an acoustic signal may be output and a text message may appear on the Control Display.











Indicator/warning lamps

The indicator and warning lamps in the instrument cluster can light up in a variety of combinations and colors.

Several of the lamps are checked for proper functioning and light up temporarily when the engine is started or the ignition is switched on.

Overview: indicator/warning lamps

Symbol	Function or system
	Turn signal.
	Parking brake.
	Parking brake in Canadian models.
	High beams.
	High-beam Assistant.
	Parking lamps, headlamp control.
	Vehicle detection, Active Cruise Control: collision warning.
	Cruise control.
	Lane departure warning.
	DSC Dynamic Stability Control.
	DSC Dynamic Stability Control.
	Tire Pressure Monitor. Flat Tire Monitor.
	Safety belts.
	Airbag system.

Symbol	Function or system
	Steering system.
	Engine functions.
	Engine functions in Canadian models.
	Brake system.
	Brake system in Canadian models.
	ABS Antilock Brake System.
	ABS Antilock Brake System in Canadian models.
	At least one Check Control message is displayed or is stored.
	M Drive 1.
	M Drive 2.
	M Dynamic Mode.

Text messages

Text messages in combination with a symbol in the instrument cluster explain a Check Control message and the meaning of the indicator and warning lamps.



Supplementary text messages

Additional information, such as on the cause of a fault or the required action, can be called up via Check Control.

The supplementary text of urgent messages is automatically displayed on the Control Display.

Symbols

Depending on the Check Control message, the following functions can be selected.

- ▷  "Owner's Manual"
Display additional information about the Check Control message in the Integrated Owner's Manual.
- ▷  "Service request"
Contact the service partner.
- ▷  "Roadside Assistance"
Contact Roadside Assistance.

Hiding Check Control messages

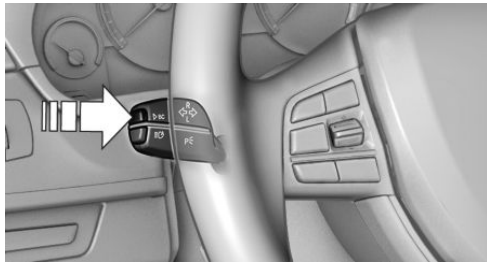

Press the computer button on the turn signal lever.

- ▷ Some Check Control messages are displayed continuously and are not cleared until the malfunction is eliminated. If several malfunctions occur at once, the messages are displayed consecutively.
These messages can be hidden for approx. 8 seconds. After this time, they are displayed again automatically.
- ▷ Other Check Control messages are hidden automatically after approx. 20 seconds. They are stored and can be displayed again later.

Displaying stored Check Control messages

1. "Vehicle Info"
2. "Vehicle status"
3.  "Check Control"
4. Select the text message.

Messages after trip completion

Special messages that are displayed during driving are displayed again after the ignition is switched off.

Fuel gauge



The vehicle inclination may cause the display to vary.

US models: the arrow beside the fuel pump symbol shows which side of the vehicle the fuel filler

flap is on.

Hints on refueling, refer to page [164](#).

Tachometer



Always avoid engine speeds in the red warning field. In this range, the fuel supply is interrupted to protect the engine.

Engine oil temperature



- ▷ Cold engine: the pointer is at the low temperature end. Drive at moderate engine and vehicle speeds.
- ▷ Normal operating temperature: the pointer is in the middle or in the left half of the temperature display.

- ▶ Hot engine: the pointer is at the high temperature end. A Check Control message is also displayed.

Coolant temperature

If the coolant along with the engine becomes too hot, a Check Control message is displayed. Check the coolant level, refer to page 181.

Odometer and trip odometer

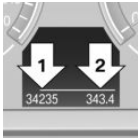

- ▶ Odometer, arrow 1.
- ▶ Trip odometer, arrow 2.

Display/reset miles



Press the knob.

- ▶ When the ignition is switched off, the time, the external temperature and the odometer are displayed.
- ▶ When the ignition is switched on, the trip odometer is reset.

External temperature

External temperature warning

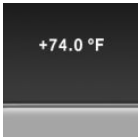

If the indicator drops to +37 °F/+3 °C or lower, a signal sounds.

A Check Control message is displayed.

There is the increased danger of ice.



Ice on roads

Even at temperatures above +37 °F/+3 °C, there can be a risk of ice on roads.

Therefore, drive carefully on bridges and shaded roads, for example, to avoid the increased risk of an accident. ◀

Time

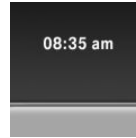

The time is displayed at the bottom of the instrument cluster.

Setting the time and time format, refer to page 91.

Date

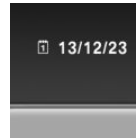

The date is displayed in the computer.

Setting the date and date format, refer to page 91.

Digital tachometer

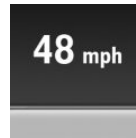

The current speed is displayed in the instrument cluster.

Activate display

1. "Settings"
2. "Info display"
3. "Digital speedometer"

Adjusting the unit

1. "Settings"
2. "Language/Units"
3. "Dig. speedo:"
4. Select the desired unit.

The setting is stored for the remote control currently in use.

Gear display with Drivelogic

Sequential mode



- ▷ Engaged gear, arrow 1.
- ▷ Selected driving program, Drivelogic, refer to page 72, arrow 2.

Drive mode

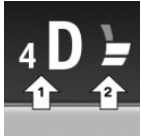

- ▷ Engaged gear together with a D, arrow 1.
- ▷ Selected driving program, Drivelogic, refer to page 72, arrow 2.

Range



After the reserve range is reached:

- ▷ A Check Control message is displayed briefly.
 - ▷ The remaining range is shown on the computer.
- ▷ When a dynamic driving style is used, such as when cornering quickly, operation of the engine is not always ensured.

The Check Control message appears continuously below a range of approx. 30 miles/50 km.



Refuel promptly

Refuel no later than at a range of 30 miles/50 km, or operation of the engine is not ensured and damage may occur. ◀

Displaying the cruising range

1. "Settings"
2. "Info display"
3. "Range"

The range is displayed in the instrument cluster.

Range when destination guidance is activated in the navigation system



When destination guidance is activated in the navigation system, the range up to the destination is displayed.

Current fuel consumption

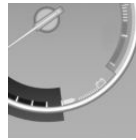

Displays the current fuel consumption. You can check whether you are currently driving in an efficient and environmentally-friendly manner.

Displaying the current fuel consumption

1. "Settings"
2. "Info display"
3. If necessary, "M dynamic driving syst."
 - The display for the current fuel consumption is active.
 - Display of the dynamic driving systems, refer to page 85.

The bar display for the current fuel consumption is displayed in the instrument cluster.

Energy recovery



The kinetic energy of the vehicle is converted to electrical energy while coasting. The vehicle battery is partially charged and fuel consumption can be lowered.

Displaying energy recovery

1. "Settings"
2. "Info display"
3. If necessary, "M dynamic driving syst."

The display for the energy recovery is active.

Display of the dynamic driving systems, refer to page 85.

EfficientDynamics display

Information on fuel consumption and technology can be displayed during driving.

1. "Vehicle Info"
2. "EfficientDynamics"

Displaying fuel consumption history

The average fuel consumption can be displayed within an adjustable time frame.

 "Consumption history"

Adjusting fuel consumption history time frame

 Select the symbol.

Resetting fuel consumption history

1. Open "Options".
2. "Reset consumption history"

Displaying EfficientDynamics info

The current efficiency can be displayed.

 "EfficientDynamics info"

The following systems are displayed:

- ▶ Automatic engine Start/Stop function.
- ▶ Energy recovery.
- ▶ Climate control output.

Driving dynamics systems



The system states of the driving dynamics are displayed in the instrument cluster.

Symbols Description



Engine Dynamics Control, refer to page 74.



Electronic Damper Control EDC, refer to page 121.



Servotronic, refer to page 122.

Activate display

1. "Settings"
2. "Info display"
3. If necessary. "M dynamic driving syst."

The display for the Driving Dynamics System is active.

Display Current fuel consumption, refer to page 84, and Energy recovery, refer to page 84.

Service requirements

Display



The driving distance or the time to the next scheduled maintenance is displayed briefly after the ignition is switched on.

The current service requirements can be read out from the remote control by the service specialist.



With TeleService, data regarding the service status or legally mandated inspections of your vehicle are automatically transmitted to your service center before the service due date.

Detailed information on service requirements

More information on the scope of service required can be displayed on the Control Display.

1. "Vehicle Info"
2. "Vehicle status"
3.  "Service required"
Required maintenance procedures and legally mandated inspections are displayed.
4. Select an entry to call up detailed information.

Symbols

Symbols	Description
	No service is currently required.
	The deadline for service or a legally mandated inspection is approaching.
	The service deadline has already passed.

Entering appointment dates

Enter the dates for the required inspections. Ensure that the vehicle date and time are set correctly.

1. "Vehicle Info"
2. "Vehicle status"
3.  "Service required"
4. "§ Vehicle inspection"
5. "Date:"
6. Adjust the settings.
7. Confirm.
The entered date is stored.

Automatic Service Request

Data regarding the service status or legally mandated inspections of the vehicle are automatically transmitted to your service center before a service due date.

You can check when your service center was notified.

1. "Vehicle Info"
2. "Vehicle status"
3. Open "Options".
4. "Last Service Request"

Gear shift indicator

The concept





The system recommends the most fuel efficient gear in the current driving situation.

Depending on how the vehicle is equipped and the country-specific version of the vehicle, the gear shift indicator is active in the manual mode of the automatic transmission and in the manual transmission.

Indicators to shift up or down are displayed in the instrument cluster.

On vehicles without a gear shift indicator, the engaged gear is displayed.

Displays

Symbol	Description
	Fuel efficient gear is engaged.
	Shift up to fuel efficient gear.
	Shift down to fuel efficient gear.
	Shift into neutral.

Speed limit detection with No Passing Information

The concept

Speed limit detection

Speed limit detection uses a symbol in the shape of a traffic sign to display the currently detected speed limit. The camera at the base of the interior rearview mirror detects traffic signs at the edge of the road as well as variable overhead sign posts. Traffic signs with extra symbols for wet road conditions, etc. are also detected and compared with vehicle interior data, such as for the rain sensor, and are displayed depending on the situation. The system takes into account the information stored in the navigation system and also displays speed limits present on routes without signs.

No Passing Information

No Passing Information in the instrument cluster displays the beginnings and ends of no passing zones detected by the camera. The system accounts for only the beginnings and ends of No Passing zones marked by signs.

No display is shown:

- ▶ In countries where No Passing zones are primarily identified with road markings.
- ▶ On routes without signage.
- ▶ Where there are railroad crossings, highway markings or other situations where no signage is present, but passing would not be permitted.

Hints



Personal judgment

The system cannot serve as a substitute for the driver's personal judgment of the traffic situation.

The system assists the driver and does not replace the human eye. ◀

At a glance

Camera

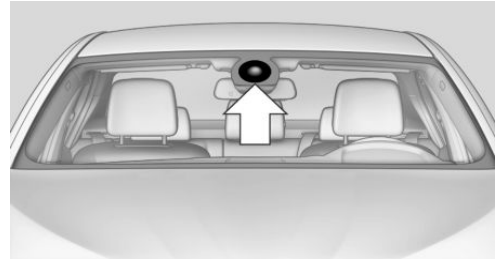

The camera is located near the base of the mirror.

Keep the windshield in the area behind the interior rear view mirror clean and clear.

Switching on/off

1. "Settings"
2. "Info display"
3. "Speed limit information"

If speed limit detection is switched on, it can be displayed on the info display in the instrument cluster via the onboard computer. No Passing Information is displayed together with the activated speed limit information.

Display

The following is displayed in the instrument cluster.

Speed limit detection

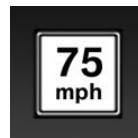

Current speed limit.



Speed limit detection is not available.

Speed limit detection can also be displayed in the Head-up Display.

No Passing Information



- ▷ Start of No Passing zone.
- ▷ End of No Passing zone.
- ▷ No Passing Information not available.

No Passing Information can also be displayed in the Head-up Display.

System limits

The system may not be fully functional and may provide incorrect information in the following situations:

- ▷ In heavy fog, rain or snowfall.
- ▷ When signs are concealed by objects.
- ▷ When driving very close to the vehicle in front of you.
- ▷ When driving toward bright lights.
- ▷ When the windshield behind the interior rearview mirror is fogged over, dirty or covered by a sticker, etc.
- ▷ In the event of incorrect detection by the camera.
- ▷ If the speed limits stored in the navigation system are incorrect.
- ▷ In areas not covered by the navigation system.
- ▷ When roads differ from the navigation, such as due to changes in the road network.
- ▷ When passing buses or trucks with a speed sticker.
- ▷ If the traffic signs are non-conforming.
- ▷ During calibration of the camera immediately after vehicle shipment.

Selection lists in the instrument cluster

The concept



The following can be operated using the buttons and the thumbwheel on the steering wheel:

- ▷ Current audio source.
- ▷ Redial on telephone.
- ▷ Activation of the voice activation system.

Activating a list and creating the setting

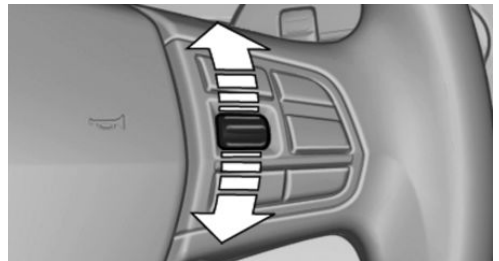

On the right side of the steering wheel, turn the thumbwheel to activate the corresponding list.

Using the thumbwheel, select the desired setting and confirm it by pressing the thumbwheel.

Computer

Indication in the info display



The information from the on-board computer is shown in the info display in the instrument cluster.

Calling up information on the info display

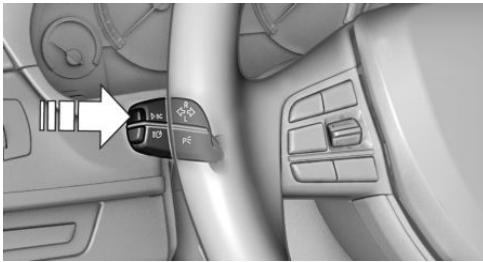

Press the on-board computer button on the turn signal lever.

Information is displayed on the info display of the instrument cluster.

Information at a glance

Repeatedly pressing the button on the turn signal lever calls up the following information on the info display:

- ▷ Range.
- ▷ Average fuel consumption.
- ▷ Average speed.
- ▷ Date.
- ▷ Speed limit detection.
- ▷ Time of arrival.

When destination guidance is activated in the navigation system.

- ▷ Distance to destination.
When destination guidance is activated in the navigation system.
- ▷ Arrow view of navigation system.

When destination guidance is activated in the navigation system.

When the arrow view in the Head-up Display is inactive.

Adjusting the info display

You can select what information from the on-board computer is to be displayed on the info display of the instrument cluster.

1. "Settings"
2. "Info display"
3. Select the desired displays.

Information in detail

Range

Displays the estimated cruising range available with the remaining fuel.

It is calculated based on your driving style over the last 20 miles/30 km. If there is only enough fuel left for less than 45 miles/80 km, the color of the display changes.

Average fuel consumption

The average fuel consumption is calculated for the period during which the engine is running.

The average fuel consumption is calculated for the distance traveled since the last reset by the on-board computer.

Average speed

Periods in which the vehicle is parked with the engine manually stopped do not enter into the calculation of the average speed.

Resetting average values

Press and hold the computer button on the turn signal lever.

Distance to destination

The distance remaining to the destination is displayed if a destination is entered in the navigation system before the trip is started.

The distance to the destination is adopted automatically.

Time of arrival

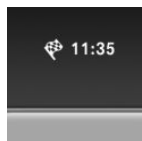

The estimated time of arrival is displayed if a destination is entered in the navigation system before the trip is started.

The time must be correctly set.

Speed limit detection

Description of the speed limit detection, refer to page 87, function.

Speed limit

Display of a speed limit which, when reached, should cause a warning to be issued.

The warning is repeated if the vehicle speed drops below the set speed limit once by at least 3 mph/5 km/h.

Displaying, setting or changing the limit

1. "Settings"
2. "Speed"
3. "Warning at:"
4. Turn the controller until the desired limit is displayed.
5. Press the controller.

The speed limit is stored.

Activating/deactivating the limit

1. "Settings"
2. "Speed"
3. "Warning"
4. Press the controller.

Setting your current speed as the limit

1. "Settings"
2. "Speed"

3. "Select current speed"

4. Press the controller.

The current vehicle speed is stored as the limit.

Trip computer

The vehicle features two types of computer.

- ▷ "Onboard info": the values can be reset as often as necessary.
- ▷ "Trip computer": the values provide an overview of the current trip.

Resetting the trip computer

1. "Vehicle Info"
2. "Trip computer"
3. "Reset": all values are reset.
"Automatically reset": all values are reset approx. 4 hours after the vehicle comes to a standstill.

Display on the Control Display

Display the onboard computer or trip computer on the Control Display.

1. "Vehicle Info"
2. "Onboard info" or "Trip computer"

Resetting the fuel consumption or speed

1. "Vehicle Info"
2. "Onboard info"
3. "Consumpt." or "Speed"
4. "Yes"

Settings on the Control Display

Time

Setting the time zone

1. "Settings"
2. "Time/Date"
3. "Time zone"
4. Select the desired time zone.

The time zone is stored.

Setting the time

1. "Settings"
2. "Time/Date"
3. "Time:"
4. Turn the controller until the desired hours are displayed.
5. Press the controller.
6. Turn the controller until the desired minutes are displayed.
7. Press the controller.

The time is stored.

Setting the time format

1. "Settings"
2. "Time/Date"
3. "Format:"
4. Select the desired format.

The time format is stored.

Date

Setting the date

1. "Settings"
2. "Time/Date"
3. "Date:"
4. Turn the controller until the desired day is displayed.

5. Press the controller.
6. Make the necessary settings for the month and year.

The date is stored.

Setting the date format

1. "Settings"
2. "Time/Date"
3. "Format:"
4. Select the desired format.

The date format is stored.

Language

Setting the language

To set the language on the Control Display:

1. "Settings"
2. "Language/Units"
3. "Language:"
4. Select the desired language.

The setting is stored for the remote control currently in use.

Setting the voice dialog

Voice dialog for the voice activation system, refer to page [23](#).

Units of measure

Setting the units of measure

To set the units for fuel consumption, route/distance and temperature:

1. "Settings"
2. "Language/Units"
3. Select the desired menu item.
4. Select the desired unit.

The setting is stored for the remote control currently in use.

Brightness

Setting the brightness

To set the brightness of the Control Display:

1. "Settings"
2. "Control display"
3. "Brightness"
4. Turn the controller until the desired brightness is set.
5. Press the controller.

The setting is stored for the remote control currently in use.

Depending on the light conditions, the brightness control may not be clearly visible.

Lamps

Vehicle equipment

All standard, country-specific and optional equipment that is offered in the model series is described in this chapter. Therefore, equipment is also described that is not available in a vehicle, e. g., because of the selected optional equipment or country variant. This also applies for safety-related functions and systems.

At a glance



- 1 Rear fog lamps
- 2 Automatic headlamp control, Adaptive Light Control, High-beam Assistant, Welcome lamps, Daytime running lights
- 3 Lamps off, daytime running lights
- 4 Parking lamps, daytime running lights
- 5 Low beams, welcome lamps, High-beam Assistant
- 6 Instrument lighting

Parking lamps/low beams, headlamp control

General information

Switch position: 0,   , 

If the driver door is opened with the ignition switched off, the exterior lighting is automatically switched off at these switch settings.

Parking lamps

Switch position  : the vehicle lamps light up on all sides, e.g., for parking.



Do not use the parking lamps for extended periods; otherwise, the battery may become discharged and it would then be impossible to start the engine.

When parking, it is preferable to switch on the one-sided roadside parking lamps, refer to page 94.

Low beams

Switch position  with the ignition switched on: the low beams light up.

Welcome lamps

When parking the vehicle, leave the switch in position  or  : the parking and interior lamps light up briefly when the vehicle is unlocked.

Activating/deactivating

1. "Settings"
2. "Lighting"
3. "Welcome lights"

The setting is stored for the remote control currently in use.

Headlamp courtesy delay feature

The low beams stay lit for a short while after the ignition is switched off, if the lamps are switched off and the headlamp flasher is switched on.

Setting the duration

1. "Settings"
2. "Lighting"
3. "Pathway lighting:"
4. Set the duration.

The setting is stored for the remote control currently in use.

Automatic headlamp control

Switch position  : the low beams are switched on and off automatically, e.g., in tunnels, in twilight or if there is precipitation. The indicator lamp in the instrument cluster lights up.

A blue sky with the sun low on the horizon can cause the lights to be switched on.



The low beams always stay on when the fog lamps are switched on.

Personal responsibility

The automatic headlamp control cannot serve as a substitute for your personal judgment in determining when the lamps should be switched on in response to ambient lighting conditions.

For example, the sensors are unable to detect fog or hazy weather. To avoid safety risks, you should always switch on the lamps manually under these conditions. ◀

Daytime running lights

With the ignition switched on, the daytime running lights light up in position 0,  or  . After the ignition is switched off, the parking lamps light up in position  .

Activating/deactivating

In some countries, daytime running lights are compulsory, so it may not be possible to deactivate the daytime running lights.

1. "Settings"
2. "Lighting"
3. "Daytime running lamps"

The setting is stored for the remote control currently in use.

Roadside parking lamps

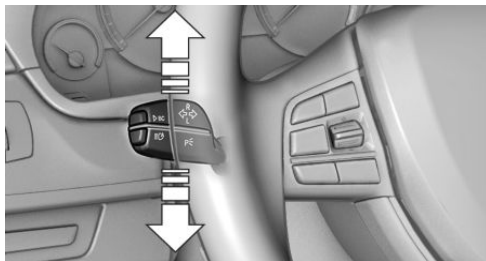

The vehicle can be illuminated on one side.

Switching on

With the ignition switched off, press the lever either up or down past the resistance point for approx. 2 seconds.

Switching off

Briefly press the lever to the resistance point in the opposite direction.

Adaptive light control

The concept

Adaptive Light Control is a variable headlamp control system that enables dynamic illumination of the road surface.

Depending on the steering angle and other parameters, the light from the headlamp follows the course of the road.

In tight curves, e.g., on mountainous roads or when turning, an additional, corner-illuminating lamp is switched on that lights up the inside of the curve when the vehicle is moving below a certain speed.

Activating

Switch position  with the ignition switched on.

The turning lamps are automatically switched on depending on the steering angle or the use of turn signals.

To avoid blinding oncoming traffic, the Adaptive Light Control does not swivel to the driver's side when the vehicle is at a standstill.

When driving in reverse, only the turning lamp is active.

Self-leveling headlamps

The self-leveling headlamps compensate for acceleration and braking operations in order not to blind the oncoming traffic and to achieve optimum illumination of the roadway.

Malfunction

A Check Control message is displayed.

Adaptive light control is malfunctioning or has failed. Have the system checked as soon as possible.



High-beam Assistant

The concept

When the low beams are switched on, this system automatically switches the high beams on and off. The procedure is controlled by a sensor on the front of the interior rearview mirror. The assistant ensures that the high beams are switched on whenever the traffic situation allows. The driver can intervene at any time and switch the high beams on and off as usual.

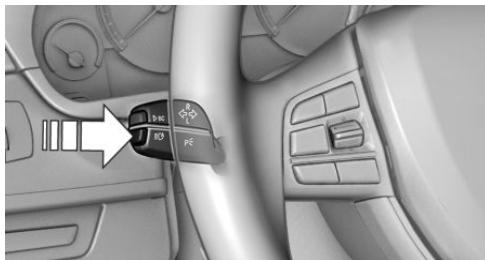
Activating



1. Turn the light switch to  or .
2. Press the button on the turn signal lever, arrow.



The indicator lamp in the instrument cluster lights up.

When the lights are switched on, the high beams are switched on and off automatically.

The system responds to light from oncoming traffic and traffic driving ahead of you, and to adequate illumination, e.g., in towns and cities.



The blue indicator lamp in the instrument cluster lights up when the system switches on the high beams.

Switching the high beams on and off manually

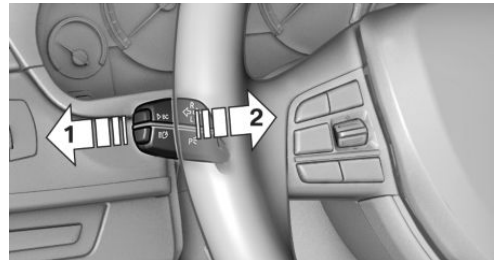

- ▷ High beams on, arrow 1.
- ▷ High beams off/headlamp flasher, arrow 2.

The High-beam Assistant can be switched off when manually adjusting the light. To reactivate the High-beam Assistant, press the button on the turn signal lever.

System limits



Personal responsibility

The high-beam assistant cannot serve as a substitute for the driver's personal judgment of when to use the high beams. Therefore, manually switch off the high beams in situations where this is required to avoid a safety risk. ◀

The system is not fully functional in situations such as the following, and driver intervention may be necessary:

- ▷ In very unfavorable weather conditions, such as fog or heavy precipitation.
- ▷ In detecting poorly-lit road users, such as pedestrians, cyclists, horseback riders and wagons; when driving close to train or ship traffic; and at animal crossings.
- ▷ In tight curves, on hilltops or in depressions, in cross traffic or half-observed on-coming traffic on freeways.
- ▷ In poorly-lit towns and cities and in the presence of highly reflective signs.
- ▷ At low speeds.
- ▷ When the windshield in front of the interior rearview mirror is fogged over, dirty or covered with stickers, etc.

Camera

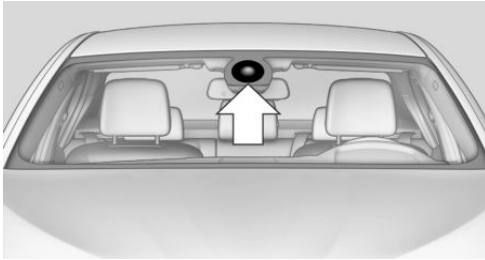

The camera is located near the base of the mirror.

Keep the windshield in the area behind the interior rear view mirror clean and clear.

Instrument lighting

Adjusting



The parking lamps or low beams must be switched on to adjust the brightness.

Adjust the brightness using the thumbwheel.

Interior lamps

General information

The interior lamps, footwell lamps, entry lamps and courtesy lamps are controlled automatically.

The brightness of some of these lamps is influenced by the thumbwheel for the instrument lighting.

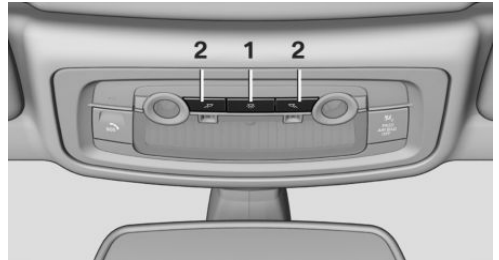

- 1 Interior lamps
- 2 Reading lamp

Switching the interior lamps on and off



Press the button.

To switch off permanently: press the button for approx. 3 seconds.

Switch back on: press button.

Reading lamps



Press the button.

When the interior lamps are switched off permanently, the reading lamps cannot be switched on.

Bang & Olufsen High End Surround Sound System

Adjusting speaker lighting

Some speakers in the vehicle are illuminated. The lighting can be individually set.

1. "Settings"
2. "Lighting"
3. "B & O"
4. Select the desired lighting setting.
 - ▷ "Off": no lighting.
 - ▷ "Reduced": the speakers in the field of view are hidden while driving.
 - ▷ "On": the speakers are always illuminated.

Safety

Vehicle equipment

All standard, country-specific and optional equipment that is offered in the model series is described in this chapter. Therefore, equip-

ment is also described that is not available in a vehicle, e. g., because of the selected optional equipment or country variant. This also applies for safety-related functions and systems.

Airbags

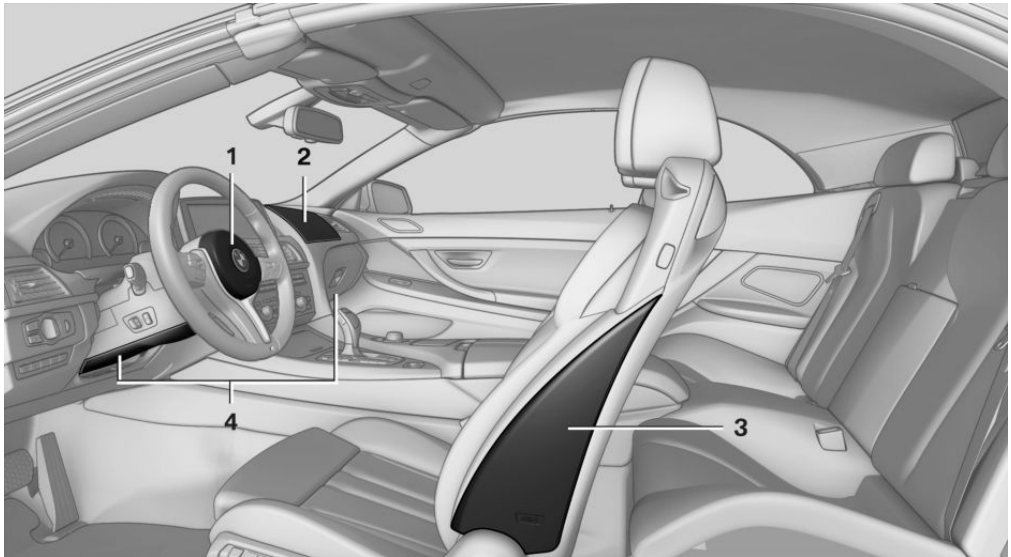

1 Front airbag, driver

2 Front airbag, front passenger

3 Side airbag

4 Knee airbags

Front airbags

Front airbags help protect the driver and front passenger by responding to frontal impacts in which safety belts alone cannot provide adequate restraint.

Side airbags

In a lateral impact, the side airbag supports the side of the body in the chest, lap, and head area.

Knee airbag

The knee airbag supports the legs in a frontal impact.

Protective action

Airbags are not triggered in every impact situation, e.g., in less severe accidents or rear-end collisions.



Information on how to ensure the optimal protective effect of the airbags

- ▷ Keep at a distance from the airbags.
- ▷ Always grasp the steering wheel on the steering wheel rim, holding your hands at the 3 o'clock and 9 o'clock positions, to keep the danger of injury to your hands or arms as low as possible if the airbag is triggered.
- ▷ There should be no people, animals, or objects between an airbag and a person.
- ▷ Do not use the cover of the front airbag on the front passenger side as a storage area.
- ▷ Keep the dashboard and window on the front passenger side clear, i.e., do not cover with adhesive labels or coverings, and do not attach holders such as for navigation instruments and mobile phones.
- ▷ Make sure that the front passenger is sitting correctly, i.e., keeps his or her feet and legs in the footwell; otherwise, leg injuries can occur if the front airbag is triggered.
- ▷ Do not place slip covers, seat cushions or other objects on the front passenger seat that are not approved specifically for seats with integrated side airbags.
- ▷ Do not hang pieces of clothing, such as jackets, over the backrests.
- ▷ Make sure that occupants keep their heads away from the side airbag; otherwise, injuries can occur if the airbags are deployed.
- ▷ Do not remove the airbag restraint system.
- ▷ Do not remove the steering wheel.
- ▷ Do not apply adhesive materials to the airbag cover panels, cover them or modify them in any way.
- ▷ Never modify either the individual components or the wiring in the airbag system. This also applies to steering wheel covers, the dashboard, and the seats. ◀

Even when all instructions are followed closely, injury from contact with the airbags cannot be ruled out in certain situations.

The ignition and inflation noise may lead to short-term and, in most cases, temporary hearing impairment in sensitive individuals.



In the case of a malfunction, deactivation and after triggering of the airbags

Do not touch the individual components immediately after the system has been triggered; otherwise, there is the danger of burns.

Only have the airbags checked, repaired or dismantled and the airbag generator scrapped by your service center or a workshop that has the necessary authorization for handling explosives.

Non-professional attempts to service the system could lead to failure in an emergency or undesired triggering of the airbag, either of which could result in injury. ◀

Warnings and information on the airbags are also found on the sun visors.

Functional readiness of the airbag system



When the ignition is switch on, the warning lamp in the instrument cluster lights up briefly and thereby indicates the operational readiness of the entire airbag system and the belt tensioner.

Airbag system malfunctioning

- ▷ Warning lamp does not come on when the ignition is turned on.
- ▷ The warning lamp lights up continuously.



When there is a malfunction, have the airbag system checked immediately

When there is a malfunction, have the airbag system checked immediately; otherwise, there is a risk that the system does not function as expected in the event of an accident despite corresponding severity of the accident. ◀

Automatic deactivation of the front passenger airbags

The system determines whether the front passenger seat is occupied by measuring the resistance of the human body.

The front, knee, and side airbag on the front passenger side are activated or deactivated accordingly.

 Leave feet in the footwell

Make sure that the front passenger keeps his or her feet in the footwell; otherwise, the front passenger airbags may not function properly. ◀

 Child restraint fixing system in the front passenger seat

Before transporting a child on the front passenger seat, refer to the safety notes and instructions under Children on the front passenger seat. ◀

Malfunction of the automatic deactivation system

When transporting older children and adults, the front passenger airbags may be deactivated in certain sitting positions. In this case, the indicator lamp for the front passenger airbags lights up.

In this case, change the sitting position so that the front passenger airbags are activated and the indicator lamp goes out.

If it is not possible to activate the airbags, have the person sit in the rear.

To make sure that the occupied seat cushion can be evaluated correctly

- ▶ Do not attach covers, cushions, ball mats or other items to the front passenger seat unless they are specifically recommended by the manufacturer of your vehicle.
- ▶ Do not place any electronic devices on the passenger seat if a child restraint system is to be installed on it.

- ▶ Do not place objects under the seat that could press against the seat from below.

Indicator lamp for the front passenger airbags

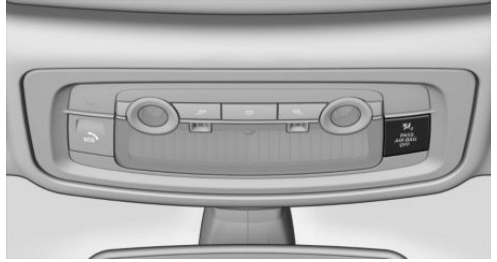

The indicator lamp for the front passenger airbags indicates the operating state of the front passenger airbags.

The lamp indicates whether the airbags are activated or deactivated.



- ▶ The indicator lamp lights up when a child who is properly seated in a child restraint fixing system intended for that purpose is detected on the seat or the seat is empty. The airbags on the front passenger side are not activated.
- ▶ The indicator lamp does not light up when, for example, a correctly seated person of sufficient size is detected on the seat. The airbags on the front passenger side are activated.

Detected child seats

The system generally detects children seated in a child seat, especially in the child seats that were required by NHTSA when the vehicle was manufactured. After installing a child seat, make sure that the indicator lamp for the front passenger airbags lights up. This indicates that the child seat has been detected and the front passenger airbags are not activated.

Strength of the driver's and front passenger airbag

The strength with which the driver's and front passenger airbags are triggered depends on the position of the driver's and front passenger seats.

To maintain the accuracy of this function over the long-term, calibrate the front seats when a corresponding message appears on the Control Display.

Calibrating the front seats

A corresponding message appears on the Control Display.

1. Move the respective seat forward all the way.
2. Move the respective seat forward again. It moves forward briefly.
3. Readjust the seat to the desired position.

The calibration procedure is completed when the message on the Control Display disappears.

If the message continues to be displayed, repeat the calibration.

If the message does not disappear after a repeat calibration, have the system checked as soon as possible.

-  **Unobstructed area of movement**
Ensure that the area of movement of the seats is unobstructed to avoid personal injury or damage to objects. ◀

Rollover protection system

The concept

The rollover protection system is automatically activated in the event of a sufficiently serious accident or if the longitudinal axis is tilted excessively. The safety frames located behind the rear headrests extend within fractions of a second.

Supplementing the reinforced front windshield frame, the rollover protection system further increases passenger safety.

-  **Maintaining movement space**
Always keep the movement space of the rollover protection system clear. Otherwise, there may be damage or injuries when the rollover protection system is triggered. ◀

Triggered rollover protection system

-  **After deployment or damage**
After deployment of the rollover protection system or in the event of damage, have the system checked and replaced.
Have this work performed only by your service center; otherwise, it cannot be ensured that this safety feature will function properly. ◀

-  **Do not move convertible top**
When the rollover protection system is extended, do not move the convertible top. Otherwise, damages or injuries may result. ◀

If the rollover protection system was not placed under any stress after an automatic triggering, it can be pushed back by hand, e.g. to close the convertible top. Three people are necessary for this.

1. Push the lever to the side and hold it in this position.

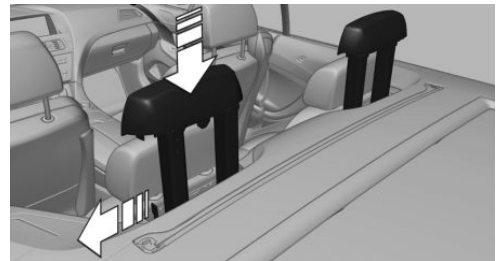

2. Push down the safety frame.
3. Release lever.
4. Hold down the safety frame.

5. Proceed likewise with the second safety frame.
6. Close the convertible top



In the event of malfunctions, deactivation or after deployment

Only have the airbags checked, repaired or dismantled and the system scrapped by your service center. Non-professional attempts to service the system could lead to failure in an emergency or undesired triggering of the airbag, either of which could result in injury. ◀

Malfunction



A Check Control message is displayed when there is a malfunction.

Tire Pressure Monitor TPM

The concept

The system monitors tire pressure in the four mounted tires. The system warns you if there is a significant loss of pressure in one or more tires. For this purpose, sensors in the tire valves measure the tire pressure and tire temperature.

Hints



Tire damage due to external factors

Sudden tire damage caused by external influences cannot be indicated in advance. ◀

Pay attention to the other information and indications under Tire inflation pressure, refer to page 167, as well when using the system.

Functional requirements

The system must have been reset with the correct tire inflation pressure; otherwise, reliable signaling of tire pressure loss is not ensured.

Reset the system again after each correction of the tire inflation pressure and after every tire or wheel change.

Always use wheels with TPM electronics to ensure that the system will operate properly.

Status display

The current status of the Tire Pressure Monitor TPM can be displayed on the Control Display, e.g., whether or not the TPM is active.

1. "Vehicle Info"
2. "Vehicle status"
3. (⚠) "Tire Pressure Monitor"

The status is displayed.

Status display

The tire and system status is indicated by the color of the wheels and a text message on the Control Display.

All wheels green

System is active and will issue a warning relative to the tire inflation pressures stored during the last reset.

One wheel is yellow

A flat tire or major drop in inflation pressure in the indicated tire.

All wheels are yellow

A flat tire or major drop in inflation pressure in several tires.

Wheels, gray

The system cannot detect a flat tire. Reasons for this may be:

- ▷ The system is being reset.
- ▷ Malfunction.

Additional information

The status display additionally shows the current tire inflation pressures and tire temperatures. The values shown are current measurement values and may vary depending on driving style or weather conditions.

Carry out reset

Reset the system after each correction of the tire inflation pressure and after every tire or wheel change.

1. "Vehicle Info"
2. "Vehicle status"
3.  "Perform reset"
4. Start the engine - do not drive away.
5. Carry out the reset with "Perform reset".
6. Drive away.

The tires are shown in gray and the status is displayed.

After driving faster than 19 mph/30 km/h for a short period, the tire inflation pressures set are accepted as reference values. The reset is completed automatically during driving.

After a successfully completed Reset, the wheels on the Control Display are shown in green and "Tire Pressure Monitor (TPM) active" is displayed.

The trip can be interrupted at any time. If you drive away again, the reset resumes automatically.

Low tire pressure message



The yellow warning lamp lights up. A Check Control message is displayed.

- ▶ There is a flat tire or a major loss in tire inflation pressure.
 - ▶ No reset was performed for the system. The system therefore issues a warning based on the tire pressures before the last reset.
1. Reduce your speed and stop cautiously. Avoid sudden braking and steering maneuvers.
 2. Identify the damaged wheel. Do so by checking the tire inflation pressure using the Mobility System. Correcting the tire inflation pressure, refer to page 175.

3. Repair flat tire with the Mobility System, refer to page 172, or replace the damaged wheel.

Required inflation pressure check message

A Check Control message is displayed.

Check the tire inflation pressure and carry out a reset of the system.

In some cases, a wheel was changed without having carried out a reset.

System limits

The system does not function properly if a reset has not been carried out, e.g., a flat tire is reported even though the tire inflation pressures are correct.

The tire pressure depends on the temperature of the tire. If the tire temperature rises, e.g., due to driving or because of the heat of the Sun, the tire inflation pressure increases also. The tire pressure is reduced when the tire temperature falls again. This behavior may cause a warning to be issued if temperatures fall very sharply.

Malfunction



The yellow warning lamp flashes and then lights up continuously. A Check Control message is displayed. No flat tire or loss of tire pressure can be detected.

Display in the following situations:

- ▶ A wheel without TPM electronics is fitted: have the service center check it if necessary.
- ▶ Malfunction: have the system checked by your service center.
- ▶ TPM was unable to complete the reset. Reset the system again.
- ▶ Disturbance by systems or devices with the same radio frequency: after leaving the area of the disturbance, the system automatically becomes active again.

Declaration according to NHTSA/ FMVSS 138 Tire Pressure Monitoring System

Each tire, including the spare (if provided) should be checked monthly when cold and inflated to the inflation pressure recommended by the vehicle manufacturer on the vehicle placard or tire inflation pressure label. (If your vehicle has tires of a different size than the size indicated on the vehicle placard or tire inflation pressure label, you should determine the proper tire inflation pressure for those tires.) As an added safety feature, your vehicle has been equipped with a tire pressure monitoring system (TPMS) that illuminates a low tire pressure telltale when one or more of your tires is significantly under-inflated. Accordingly, when the low tire pressure telltale illuminates, you should stop and check your tires as soon as possible, and inflate them to the proper pressure. Driving on a significantly under-inflated tire causes the tire to overheat and can lead to tire failure. Under-inflation also reduces fuel efficiency and tire tread life, and may affect the vehicle's handling and stopping ability. Please note that the TPMS is not a substitute for proper tire maintenance, and it is the driver's responsibility to maintain correct tire pressure, even if under-inflation has not reached the level to trigger illumination of the TPMS low tire pressure telltale. Your vehicle has also been equipped with a TPMS malfunction indicator to indicate when the system is not operating properly. The TPMS malfunction indicator is combined with the low tire pressure telltale. When the system detects a malfunction, the telltale will flash for approximately one minute and then remain continuously illuminated. This sequence will continue upon subsequent vehicle start-ups as long as the malfunction exists. When the malfunction indicator is illuminated, the system may not be able to detect or signal low tire pressure as intended. TPMS malfunctions may occur for a variety of reasons, including the installation of replacement or alternate tires or wheels on the vehicle

that prevent the TPMS from functioning properly. Always check the TPMS malfunction telltale after replacing one or more tires or wheels on your vehicle to ensure that the replacement or alternate tires and wheels allow the TPMS to continue to function properly.

FTM Flat Tire Monitor

The concept

The system does not measure the actual inflation pressure in the tires.

It detects a pressure loss in a tire by comparing the rotational speeds of the individual wheels while moving.

In the event of a pressure loss, the diameter and therefore the rotational speed of the corresponding wheel change. This is detected and reported as a flat tire.

Functional requirements

The system must have been initialized when the tire inflation pressure was correct; otherwise, reliable signaling of a flat tire is not ensured. Initialize the system after each correction of the tire inflation pressure and after every tire or wheel change.

Status display

The current status of the Flat Tire Monitor can be displayed on the Control Display, e.g., whether or not the FTM is active.

1. "Vehicle Info"
2. "Vehicle status"
3. (⚠) "Flat Tire Monitor (FTM)"

The status is displayed.

Initialization

The initialization process adopts the set inflation tire pressures as reference values for the detection of a flat tire. Initialization is started by confirming the inflation pressures.

Do not initialize the system when driving with snow chains.

1. "Vehicle Info"
2. "Vehicle status"
3.  "Perform reset"
4. Start the engine - do not drive away.
5. Start the initialization with "Perform reset".
6. Drive away.

The initialization is completed while driving, which can be interrupted at any time.

The initialization automatically continues when driving resumes.

Indication of a flat tire



The yellow warning lamp lights up. A Check Control message is displayed.

There is a flat tire or a major loss in tire inflation pressure.

1. Reduce your speed and stop cautiously. Avoid sudden braking and steering maneuvers.
2. Identify the damaged wheel. Do so by checking the tire inflation pressure using the Mobility System. If the tire inflation pressure in all tires is correct, the Flat Tire Monitor may not have been initialized. In this case, initialize the system.
3. Repair flat tire with the Mobility System, refer to page 172, or replace the damaged wheel.

System limits



Sudden tire damage

Sudden serious tire damage caused by external influences cannot be indicated in advance. ◀

A natural, even pressure loss in all four tires cannot be detected. Therefore, check the tire inflation pressure regularly.

The system could be delayed or malfunction in the following situations:

- ▷ When the system has not been initialized.
- ▷ When driving on a snowy or slippery road surface.
- ▷ Sporty driving style: slip in the drive wheels, high lateral acceleration.
- ▷ When driving with snow chains.

Intelligent Safety

The concept

Depending on how the vehicle is equipped, Intelligent Safety consists of one or more of the following systems, which can help to avoid an imminent collision. These systems are active automatically every time the engine is started using the Start/Stop button:

- ▷ Collision warning with City Braking function, refer to page 106.
- ▷ Pedestrian warning, refer to page 108.

Note



Personal responsibility

The system does not serve as a substitute for the driver's personal judgment of the traffic situation.

Be aware of the traffic situation and the vehicle's surroundings at all times, otherwise an accident is still possible despite all warnings. ◀

At a glance

Button in the vehicle



Intelligent Safety button

Switching on/off

The Intelligent Safety systems are automatically active after each engine start via the start/stop button.



Press the button: the systems are switched off. The LED goes out.

Press the button: the systems are switched off. The LED lights up.

Settings can be made on the Control Display.

Collision warning with City Braking function

The concept

The system can help to prevent accidents. If an accident cannot be prevented, the system helps to reduce the collision speed.

The system issues a warning if there is imminent danger of a collision and if so brakes independently.

The automatic braking intervention is done with limited force and duration.

The system is controlled via a camera in the base of the mirror.

The collision warning is available even if cruise control has been deactivated.

When the vehicle is intentionally brought close to a vehicle, the collision warning is delayed to avoid false warnings.

General information

The system issues a two-phase warning of a danger of collision with vehicles at speeds above approx. 3 mph/5 km/h. The time of these warnings may vary depending on the current driving situation.

Up to approx. 35 mph/60 km/h a braking intervention occurs when appropriate.

Detection range

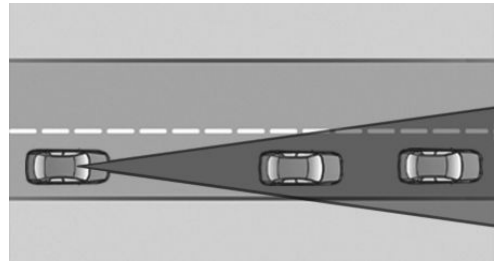

Vehicles are observed when they are traveling in the same direction of movement if they are located within the detection range of the system.

At a glance

Button in the vehicle



Intelligent Safety button

Switching on/off

Switching on automatically

The system is automatically active every time the engine is started using the Start/Stop button.

Switching off

The system is only switched off until the next time the engine is started with the Start/Stop button.



Press the button.

The LED goes out.

Warning with braking function





Adapting your speed and driving style

The warning does not relieve the driver of the responsibility to adapt his or her driving speed and style to the traffic conditions. ◀

Display

If a collision with a vehicle detected in this way is imminent, a warning symbol appears on the instrument cluster and in the Head-up Display.

Symbol	Measure
	The vehicle lights up red: prewarning. Increase braking and distance.
	The vehicle flashes red and an acoustic signal sounds: acute warning. You are requested to intervene by braking or making an evasive maneuver.

Braking intervention

The warning prompts the driver himself to intervene. During the warning, the maximum braking force is used, even with light pressure on the brake pedal. In addition, if there is a risk

of collision, the system can assist with a slight braking intervention. The intervention can bring a vehicle traveling at slow speed to a complete stop.

Manual transmission: During a braking intervention up until reaching a complete stop, the engine may be shut down.

The braking intervention is executed only if DSC Dynamic Stability Control is switched on and Dynamic Traction Control DTC is activated.

The braking intervention can be interrupted by pressing on the accelerator or by actively moving the steering wheel.

When towing or tow-starting the vehicle, switch off the collision warning with braking function to prevent undesired interventions.

System limits



Be alert

Due to system limitations, warnings may be not be issued at all, or may be issued late or improperly. Therefore, always be alert and ready to intervene; otherwise, there is the danger of an accident occurring. ◀

Detection range

The system's detection capabilities are limited. This may result in the warning not being issued or being issued late.

For example, the following situations may not be detected:

- ▷ Slow moving vehicles when you approach them at high speed.
- ▷ Vehicles that suddenly swerve in front of you or sharply decelerating vehicles.
- ▷ Vehicles with an unusual rear appearance.
- ▷ Two-wheeled vehicles ahead of you.
- ▷ Pedestrians.

Functional limitations

The system may not be fully functional in the following situations:

- ▷ In heavy fog, rain, sprayed water or snow-fall.
- ▷ In tight curves.
- ▷ If the driving stability control systems are limited or deactivated, for example, DSC OFF.
- ▷ If the camera in the mirror or the radar sensor is dirty or obscured.
- ▷ During calibration of the camera immediately after vehicle shipment.
- ▷ If there is constant dimming because of oncoming light, for example, from the sun low in the sky.

Prewarning sensitivity

Depending on the set prewarning time, this may result in increased false warnings.

Pedestrian warning

Depending on how the vehicle is equipped, the function warns of an imminent collision with pedestrians during daytime or nighttime.

The function is subdivided into the following systems:

- ▷ During daytime: Pedestrian warning with city braking function, refer to page [108](#)
- ▷ At night: Night Vision with pedestrian detection, refer to page [110](#)

Pedestrian warning with city braking function

The concept

The system can help to prevent accidents with pedestrians.

The system issues a warning in the city driving speed area if there is imminent danger of a col-

lision with pedestrians and includes a braking function.

The system is controlled via the camera in the base of the interior mirror.

General information

The system issues a warning with brightness starting at approx. 6 mph/10 km/h to approx. 35 mph/60 km/h regarding a possible risk of collision with pedestrians and assists with a brake intervention shortly before a collision.

It responds to persons that are within the detection range of the system.

Detection range

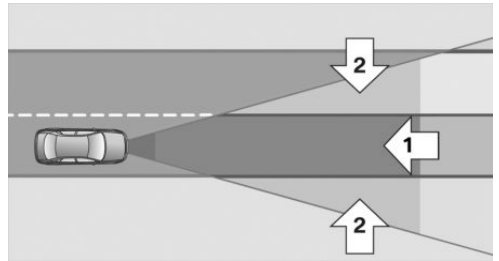

The warning area in front of the vehicle is divided into two areas.

- ▷ Central area, arrow 1, directly in front of the vehicle.
- ▷ Expanded area, arrow 2, to the right and left.

A collision is imminent if pedestrians are located within the central area. A warning is issued about pedestrians who are located within the extended area only if they are moving in the direction of the central area.

At a glance

Button in the vehicle



Intelligent Safety button

Camera

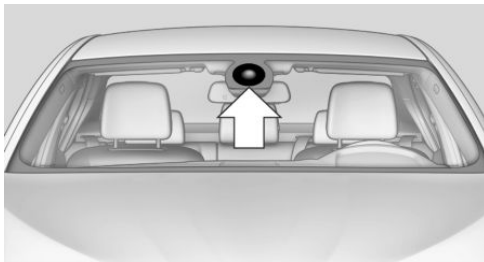

The camera is located near the base of the mirror.

Keep the windshield in the area behind the interior rear view mirror clean and clear.

Switching on/off

Switching on automatically

The system is automatically active every time the engine is started using the Start/Stop button.

Switching off



Press the button: the systems are switched off. The LED goes out.

Press the button: the systems are switched off. The LED lights up.

Warning with braking function



Adapting your speed and driving style

The warning does not relieve the driver of the responsibility to adapt his or her driving speed and style to the traffic conditions. ◀

Display

If a collision with a person detected in this way is imminent, a warning symbol appears on the instrument cluster and in the Head-up Display.



The red symbol is displayed and a signal sounds.

Intervene immediately by braking or making an evasive maneuver.

Braking intervention

The warning prompts the driver himself to intervene. During the warning, the maximum braking force is used, even with light pressure on the brake pedal. In addition, if there is a risk of collision, the system can assist with a slight braking intervention. The intervention can bring a vehicle traveling at slow speed to a complete stop.

Manual transmission: During a braking intervention up until reaching a complete stop, the engine may be shut down.

The braking intervention is executed only if DSC Dynamic Stability Control is switched on and Dynamic Traction Control DTC is activated.

The braking intervention can be interrupted by pressing on the accelerator or by actively moving the steering wheel.

When towing or tow-starting the vehicle, switch off the pedestrian warning to prevent undesired interventions.

System limits



Be alert

Due to system limitations, warnings may be not be issued at all, or may be issued late or improperly. Therefore, always be alert and ready to intervene; otherwise, there is the danger of an accident occurring. ◀

Detection range

The detection capability of the camera is limited.

This may result in the warning not being issued or being issued late.

For example, the following situations may not be detected:

- ▷ Partially covered pedestrians.
- ▷ Pedestrians that are not detected as such because of the viewing angle or contour.
- ▷ Pedestrians outside of the detection range.
- ▷ Pedestrians below a body size of approx. 32 in/80 cm.

Functional limitations

The system may not be fully functional or may not be available in the following situations:

- ▷ In heavy fog, rain, sprayed water or snowfall.
- ▷ In tight curves.
- ▷ If the camera view field or the front windshield are dirty or covered.
- ▷ When driving toward bright lights.
- ▷ Up to 10 seconds after the start of the engine, via the Start/Stop knob.
- ▷ During calibration of the camera immediately after vehicle shipment.

Night Vision with Pedestrian and Animal Detection

The concept

Night Vision with pedestrian and animal detection is a night vision system.

An infrared camera records the area in front of the vehicle and issues a warning if it detects pedestrians and animals on the street. Warm objects that are similar in shape to human beings or animals are detected by the system. If necessary, the heat image can be displayed on the Control Display.

Heat image



The image shows the heat radiated by objects in the field of view of the camera.

Warm objects have a light appearance and cold objects, a dark appearance.

The ability to detect an object depends on the temperature difference between the object and the background and on the level of heat radiation emitted by the object. Objects that are similar in temperature to the environment or that radiate very little heat are difficult to detect.

For safety reasons, when driving at speeds above approx. 3 mph/5 km/h and in low ambient light, the image is only displayed when the low beams are switched on.

A still image is displayed at regular intervals for a fraction of a second.

Pedestrian and animal detection



Object detection and warning only functions in darkness.

Warm objects that are similar in shape to human beings are detected by the system.

In addition, the system also detects animals above a certain minimum size, e.g., deer.

With heat image activated on the Control Display:

People detected by the system are displayed with a slight yellow hue.

Animals detected by the system are displayed in a darker yellow.

Under good ambient conditions, the object detection operates within the following distance ranges:

- ▶ Pedestrian detection: up to approx. 330 ft/100 m
- ▶ Detection of large animals: up to approx. 490 ft/150 m
- ▶ Detection of medium animals: up to approx. 230 ft/70 m

Environmental influences can limit the availability of object detection.

If the vehicle systems detect that the vehicle is located in a residential area, the animal detection is temporarily switched off.

Notes



Personal responsibility

Night Vision cannot replace the driver's personal judgment of the visibility conditions and the traffic situation. The view ahead and the actual visibility conditions must always be the basis on which the vehicle speed is adjusted; otherwise, there is a risk to road safety. ◀

At a glance

Buttons in the vehicle



Intelligent Safety button



Switch on/switch off heat image

Camera

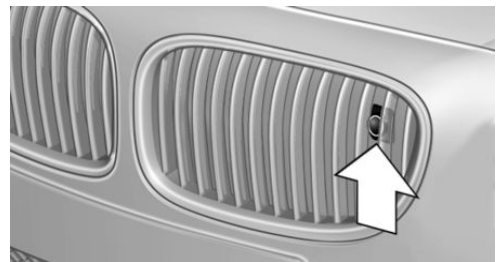

The camera is automatically heated when the external temperatures are low.

The camera is automatically cleaned together with the headlamps.

Switching on/off

Switching on automatically

Every time the engine is started using the Start/Stop button, the system is automatically active at dark.

Switching off

The system is only switched off until the next time the engine is started with the Start/Stop button.



Press the button.

The LED goes out.

Switching on heat image additionally

The heat image from the Night Vision camera can also be displayed on the Control Display. This function has no effect on object detection.



Press the button.

The image from the camera is displayed on the Control Display.

Adjustments via the iDrive

With heat image switched on:

1. Press the controller.
2. Select brightness or contrast.
 - ▶ ☀ Select the symbol.
 - ▶ ● Select the symbol.
3. Turn the controller until the desired setting is reached, and press the controller.

Display

Warning of people or animals in danger

If a collision with a person or an animal detected in this way is imminent, a warning symbol appears on the instrument cluster and in the Head-up Display.

Although both the shape and the heat radiation are analyzed, false warnings cannot be ruled out.

Warning area in front of the vehicle

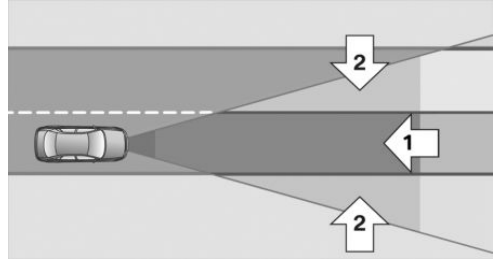

The warning area for the pedestrian warning consists of two parts:

- ▶ Central area, arrow 1, directly in front of the vehicle.
- ▶ Expanded area, arrow 2, to the right and left.

In the animal warning, no distinction is made between the central or expanded area.

The entire area moves along with the vehicle in the direction of the steering angle and changes with the vehicle speed. As the vehicle speed increases, the area becomes longer and wider, for example.

Prewarning



The yellow symbol is displayed when a person is detected in the central area, arrow 1, immediately in front of the vehicle.

The yellow symbol is displayed when a person in the extended area, arrow 2, is moving from the right or left towards the central area.

The displayed symbol can vary with the people detected.

Intervene actively by braking or making an evasive maneuver.



When animals are detected, an animal symbol is displayed. The symbol also shows the side of the road on which the animal was detected. Intervene actively by braking or making an evasive maneuver.

Acute warning



The red symbol is displayed and a signal sounds.

Intervene immediately by braking or making an evasive maneuver.

With animals no acute warning occurs.

Display in the Head-up Display



The warning is displayed simultaneously in the Head-up Display and on the instrument cluster. The displayed symbol can vary with the people detected.

When animals are detected, an animal symbol is displayed.

System limits

Basic limits

System operation is limited in situations such as the following:

- ▷ On steep hills, in steep depressions or in tight curves.
- ▷ When the camera is dirty or the protective glass is damaged.
- ▷ In heavy fog, rain or snowfall.
- ▷ At very high external temperatures.

Limits of pedestrian and animal detection

In some situations, it may occur that pedestrians are detected as animals or animals as pedestrians.

Small animals are not detected by the object detection function, even if they are clearly visible in the image.

Limited detection:

- ▷ People or animals who are fully or partially covered, especially when their heads are covered.
- ▷ People who are not in an upright position, e.g., lying down.
- ▷ Cyclists on unconventional bicycles (e.g., recumbent bicycles).
- ▷ After physical damage to the system, e.g., after an accident.

Lane departure warning

The concept

Starting at a specific speed, this system alerts you when the vehicle on streets with lane markings is about to leave the lane. Depending on the country-specific version of the vehicle, the speed is between 35 mph/55 km/h and 45 mph/70 km/h. If the system is switched on below this speed, a message appears in the instrument cluster.

The steering wheel begins vibrating gently in the event of warnings. The time of the warning may vary depending on the current driving situation.

The system does not provide a warning if the turn signal is set before leaving the lane.

Notes



Personal responsibility

The system cannot serve as a substitute for the driver's personal judgment of the course of the road and the traffic situation.

In the event of a warning, do not jerk the steering wheel, as you may lose control of the vehicle. ◀

At a glance

Button in the vehicle



Lane departure warning

Camera

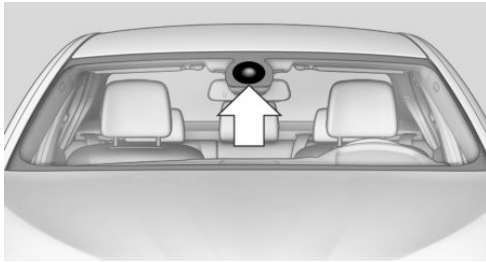

The camera is located near the base of the mirror.

Keep the windshield in the area behind the interior rear view mirror clean and clear.

Switching on/off



Press the button.

- ▷ On: the LED lights up.
- ▷ Off: the LED goes out.

The state is stored for the remote control currently in use.

Display in the instrument cluster



- ▷ Lines: system is activated.

- ▷ Arrows: at least one lane marking was detected and warnings can be issued.

Issued warning

If you leave the lane and if a lane marking has been detected, the steering wheel begins vibrating.

If the turn signal is set before changing the lane, a warning is not issued.

End of warning

The warning ends:

- ▷ Automatically after approx. 3 seconds.
- ▷ When returning to your own lane.
- ▷ When braking hard.
- ▷ When using the turn signal.

System limits

The system may not be fully functional in the following situations:

- ▷ In heavy fog, rain or snowfall.
- ▷ In the event of worn, poorly visible, merging, diverging, or multiple lane markings such as in construction areas.
- ▷ When lane markings are covered in snow, ice, dirt or water.
- ▷ In tight curves or on narrow lanes.
- ▷ When the lane markings are covered by objects.
- ▷ When driving very close to the vehicle in front of you.
- ▷ When driving toward bright lights.
- ▷ When the windshield in front of the interior rearview mirror is fogged over, dirty or covered with stickers, etc.
- ▷ During calibration of the camera immediately after vehicle shipment.

Active Blind Spot Detection

The concept

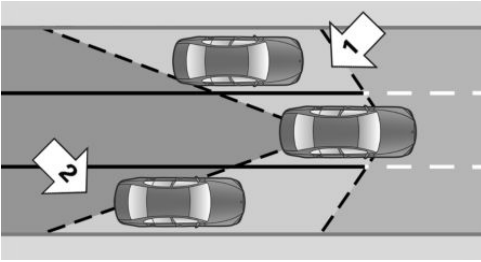

Two radar sensors below the rear bumper monitor the area behind and next to the vehicle at speeds above approx. 30 mph/50 km/h.

The system indicates whether there are vehicles in the blind spot, arrow 1, or approaching from behind on the adjacent lane, arrow 2.

The lamp in the exterior mirror housing lights up dimly.

Before you change lanes after setting the turn signal, the system issues a warning in the situations described above.

The lamp in the housing of the exterior mirror flashes and the steering wheel vibrates.

Notes



Personal responsibility

The system does not serve as a substitute for the driver's personal judgment of the traffic situation.

Be aware of the traffic situation and the vehicle's surroundings at all times, otherwise an accident is still possible despite all warnings. ◀

At a glance

Button in the vehicle



Active Blind Spot Detection

Radar sensors



The radar sensors are located under the rear bumper.

Switching on/off



Press the button.

- ▷ On: the LED lights up.
- ▷ Off: the LED goes out.

The system can issue warnings at speeds above approx. 30 mph/50 km/h.

The state is stored for the remote control currently in use.

Display

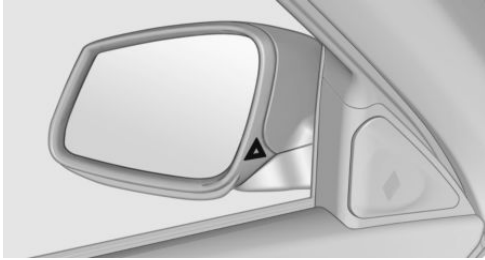

Information stage

The dimmed lamp in the mirror housing indicates when there are vehicles in the blind spot or approaching from behind.

Warning

If the turn signal is set while a vehicle is in the critical zone, the steering wheel vibrates briefly and the lamp in the mirror housing flashes brightly.

The warning stops when the turn signal is switched off, or the other vehicle leaves the critical zone.

System limits

The system may not be fully functional in the following situations:

- ▷ When a vehicle is approaching at a speed much faster than your own.
- ▷ In heavy fog, rain or snowfall.
- ▷ In tight curves or on narrow lanes.
- ▷ If the bumper is dirty or iced up, or covered with stickers.

A Check Control message is displayed when the system is not fully functional.

For US owners only

The transmitter and receiver units comply with part 15 of the FCC/Federal Communication Commission regulations. Operation is governed by the following:

FCC ID:

- ▷ NBG009014A.

Compliance statement:

This device complies with part 15 of the FCC Rules. Operation is subject to the following two conditions:

- ▷ This device may not cause harmful interference, and
- ▷ this device must accept any interference received, including interference that may cause undesired operation.

Any unauthorized modifications or changes to these devices could void the user's authority to operate this equipment.

Brake force display

The concept



- ▷ During normal brake application, the outer brake lamps light up.
- ▷ During heavy brake application, the inner brake lamps light up in addition.

Active Protection

General information

The Active Protection safety package consists of systems that are independent of each other:

- ▷ Attentiveness assistant.
- ▷ PreCrash
- ▷ PostCrash

Attentiveness assistant

The concept

The system can detect increasing lack of alertness or fatigue of the driver during long, monotonous journeys, for example, on highways. In this situation, it is recommended that the driver take a break.

Note



Personal responsibility

The system cannot act as a substitute for the personal assessment of one's physical state and may not detect an increasing lack of alertness or fatigue or may not detect it correctly. Therefore, make sure that the driver is rested and alert; otherwise, risks may be detected too late and an accident be caused as a result. ◀

Function

The system is activated each time the engine is started and cannot be switched off.

After travel has begun, the system is trained about the driver, so that increasing lack of alertness or fatigue can be detected.

This procedure takes the following criteria into account:

- ▶ Personal driving style, for example, steering behavior.
- ▶ Driving conditions, for example, length of trip.

Starting at approximately 43 mph/70 km/h, the system is active and can display a recommendation to take a break.

Break recommendation

If the driver becomes increasingly less alert or fatigued, a message is displayed in the Control Display with the recommendation to take a break.

A recommendation to take a break is displayed only once during an uninterrupted trip.

After a break, another recommendation to take a break cannot be displayed until after approximately 45 minutes.

System limits

The function may be limited in the following situations, for instance, and will either output an incorrect warning or no warning at all:

- ▶ When the clock is set incorrectly.
- ▶ When the vehicle speed is mainly below about 43 mph/70 km/h.
- ▶ With a sporty driving style, such as during rapid acceleration or when cornering quickly.
- ▶ In active driving situations, such as when changing lanes frequently.
- ▶ When the road surface is poor.
- ▶ In the event of strong side winds.

PreCrash

The concept

With this system critical driving situations that might result in an accident can be detected above a speed of approx. 20 mph/30 km/h. In these situations, preventative protection measures are automatically undertaken to minimize the risk in the event of an accident as much as possible.

Critical driving situations may include:

- ▶ Full brake applications.

Note



Personal responsibility

The system cannot possibly serve as a substitute for the driver's personal judgment of the traffic situation. The system may not always detect critical situations reliably and in a timely manner. Adapt speed to traffic situation

and drive alertly; otherwise, a risk to safety may result. ◀

Function

After the safety belt is buckled, the front belts are automatically pretensioned once after the vehicle is driven is away.

In critical driving situations, the following individual functions become active as needed:

- ▷ The front belts are automatically pretensioned.
- ▷ Automatic closing of the windows.
- ▷ For vehicles equipped with Comfort Seats: automatic positioning of the backrest for the front passenger seat.

After a critical driving situation without an accident, the front belts are loosened again. All other systems can be restored to the desired setting.

If the belt tension does not loosen automatically, stop the vehicle and unbuckle the belt using the red button in the buckle. Fasten the belt before continuing on your trip.

PostCrash

In the event of an accident, the system can bring the car to a halt automatically without intervention by the driver in certain situations. This can reduce the risk of a further collision and the consequences thereof.

Depressing the brake pedal can cause the vehicle to brake harder. This interrupts automatic braking. Depressing the accelerator pedal also interrupts automatic braking.

After coming to a halt, the brake is released automatically. Secure the vehicle against rolling.

Driving stability control systems

Vehicle equipment

All standard, country-specific and optional equipment that is offered in the model series is described in this chapter. Therefore, equipment is also described that is not available in a vehicle, e. g., because of the selected optional equipment or country variant. This also applies for safety-related functions and systems.

Antilock Brake System ABS

ABS prevents locking of the wheels during braking.

The vehicle remains steerable even during full brake applications, thus increasing active safety.

ABS is operational every time you start the engine.

Brake assistant

When you apply the brakes rapidly, this system automatically produces the maximum braking force boost. This then reduces braking distance to a minimum during full braking. This system utilizes all of the benefits provided by ABS.

Do not reduce the pressure on the brake pedal for the duration of the full braking.

Drive-off assistant

This system supports driving away on gradients. The parking brake is not required.

1. Hold the vehicle in place with the foot brake.
2. Release the foot brake and drive away without delay.

After the foot brake is released, the vehicle is held in place for approx. 2 seconds.

Depending on the vehicle load, the vehicle may roll back slightly.



Driving off without delay

After releasing the foot brake, start driving without delay, since the drive-off assistant will not hold the vehicle in place for more than approx. 2 seconds and the vehicle will begin rolling back. ◀

DSC Dynamic Stability Control

The concept

DSC prevents traction loss in the driving wheels when driving away and accelerating.

DSC also recognizes unstable vehicle conditions, such as fishtailing or nose-diving. Subject to physical limits, DSC helps to keep the vehicle on a steady course by reducing engine speed and by applying brakes at individual wheels.



Adjust your driving style to the situation

An appropriate driving style is always the responsibility of the driver.

The laws of physics cannot be repealed, even with DSC.

Therefore, do not reduce the additional safety margin by driving in a risky manner. ◀

Indicator/warning lamps



The indicator lamp flashes: DSC controls the drive forces and brake forces.

The indicator lamp lights up: DSC has failed.

M Dynamic Mode MDM

M Dynamic Mode makes it possible to drive on a dry roadway with high longitudinal and transverse acceleration but with limited driving stability.

Only in the absolute limit area does the system intervene for stabilization by reducing the engine power and by braking interventions on the wheels. In this driving condition, additional steering corrections may be necessary.

Limited stabilizing interventions

When M Dynamic Mode is activated, stabilizing interventions are carried out only to a reduced extent. You must react yourself; otherwise, there is the danger of an accident occurring. ◀

To increase vehicle stability, activate DSC again as soon as possible.

Activating MDM

 Press the button briefly.

The MDM and DSC OFF indicator lamps on the instrument cluster light up.

Deactivating MDM

 Press the button.

The MDM and DSC OFF indicator lamps go out.

Via M Drive

1. "Settings"
2. "M Drive 1" or "M Drive 2"
3.  Select the symbol.
4. "MDM"

To open M Drive with the selected settings, press the corresponding button on the steering wheel:



A message appears in the instrument cluster. This message is confirmed by pressing the button again.

Deactivating MDM

Press the appropriate button 1 or button 2 on the steering wheel again.

M Dynamic Mode and the settings selected under M Drive are deactivated.

Indicator/warning lamps

 Indicator lamps light up:
M Dynamic Mode is activated.



 DSC indicator lamp also flashes:
M Dynamic Mode controls the drive forces and brake forces.

 Indicator lamps light up:
M Dynamic Mode or DSC has failed.



Deactivating DSC: DSC OFF

When DSC is deactivated, driving stability is reduced during acceleration and when driving in bends.

To increase vehicle stability, activate DSC again as soon as possible.

Deactivating DSC

 Press and hold the button, but not longer than approx. 10 seconds, until the indicator lamp for DSC OFF lights up in the instrument cluster and DSC OFF is displayed.

The DSC system is switched off.

Activating DSC



Press the button.

DSC OFF and the DSC OFF indicator lamp go out.

Via M Drive

1. "Settings"
2. "M Drive 1" or "M Drive 2"
3.  Select the symbol.
4. "DSC OFF"

To open M Drive with the selected settings, press the corresponding button on the steering wheel:



A message appears in the instrument cluster. This message is confirmed by pressing the button again.

Indicator/warning lamps

When DSC is deactivated, DSC OFF is displayed in the instrument cluster.



The indicator lamp lights up: DSC is deactivated.

Hill Start Assistant

The Hill Start Assistant provides assistance with starting off on a hill, Drive-off assistant, refer to page 119.

Active M differential

The concept

The active M differential assures continuously variable locking of the rear axle differential depending on the driving situation. This prevents individual rear wheels from spinning even when DSC is switched off and in M Dynamic

Mode, so that optimum traction is always assured in all driving situations.

The driver is responsible adapting his or her driving behavior to the situation.

Electronic Damper Control EDC

The concept

This system reduces undesirable vehicle motion when using a dynamic driving style or traveling on uneven road surfaces.

The system enhances driving dynamics and comfort as required for the road surface and driving style.

Programs

Setting options for calibrating the shock absorbers:

- ▷ "Comfort": comfort-oriented.
- ▷ "Sport": balanced out.
- ▷ "Sport Plus": consistently sporty.

Selecting a channel

Via M Drive

1. "Settings"
2. "M Drive 1" or "M Drive 2"
3.  Select the symbol.
4. Select the desired channel.

When M Drive is active, setting is immediately applied.

To activate M Drive with the selected settings, press the corresponding button on the steering wheel:



Using the button



 Press button repeatedly until the desired program is displayed in the instrument cluster.

Display in the instrument cluster

 Electronic Damper Control EDC with selected program System states of the driving dynamics, refer to page 85.

Servotronic

The concept

The Servotronic varies the steering force required to turn the wheels in accordance with the vehicle speed. At low speeds, the steering force is strongly supported, i. e. during steering, low force is required. As the speed increases, the assistance of the steering force is reduced.

Programs

Steering force setting options:

- ▷ "Comfort": low.
- ▷ "Sport": medium.
- ▷ "Sport Plus": high.

Selecting a channel

Via M Drive

1. "Settings"
2. "M Drive 1" or "M Drive 2"

3.  Select the symbol.

4. Select the desired channel.

When M Drive is active, setting is immediately applied.

To activate M Drive with the selected settings, press the corresponding button on the steering wheel:



Using the button



 Press button repeatedly until the desired program is displayed in the instrument cluster.

Display in the instrument cluster

 Servotronic with selected program with activated display of the System states of the driving dynamics, refer to page 85.

Driving comfort

Vehicle equipment

All standard, country-specific and optional equipment that is offered in the model series is described in this chapter. Therefore, equipment is also described that is not available in a vehicle, e. g., because of the selected optional equipment or country variant. This also applies for safety-related functions and systems.

Cruise control

The concept

The system is functional at speeds beginning at approx. 20 mph/30 km/h.

It maintains the speed that was set using the control elements on the steering wheel.

The system brakes on downhill gradients if engine braking action is insufficient.

Unfavorable conditions





Do not use the system if unfavorable conditions make it impossible to drive at a constant speed, for instance:

- ▶ On curvy roads.
- ▶ In heavy traffic.
- ▶ On slippery roads, in fog, snow or rain, or on a loose road surface.

Otherwise, you could lose control of the vehicle and cause an accident. ◀

Controls

At a glance

Press the button	Function
	Cruise control on/off, interrupting, refer to page 123
	Store/maintain speed, refer to page 124
	Resume speed, refer to page 124
	Rocker switch: Change/maintain speed, refer to page 124

The arrangement of the buttons varies according to the how the vehicle is equipped or country-specific variants.

Switching on

 Press the button on the steering wheel.

The marking in the speedometer is set to the current speed.

The cruise control can be used.

Switching off

 Deactivated or interrupted system
If the system is deactivated or interrupted, actively intervene by braking and, if necessary, with evasive maneuvers; otherwise, there is the danger of an accident occurring. ◀

 Press the button on the steering wheel.

- ▶ If active: press twice.

- ▷ If interrupted: press once.

The displays go out. The stored desired speed is deleted.

Interrupting

 When active, press the button.

The system is automatically interrupted if:

- ▷ The brakes are applied.
- ▷ The transmission position D is disengaged.
- ▷ MDM is activated or DSC is deactivated.
- ▷ DSC is actively controlling stability.

Maintaining/storing the current speed

 Press the button.
Or:

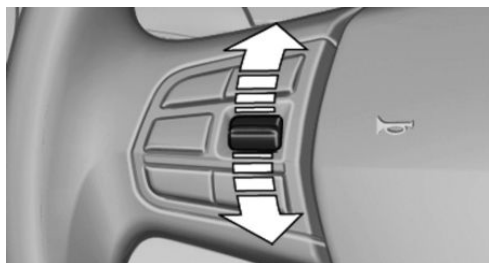

Press the rocker switch while the system is interrupted.

When the system is switched on, the current speed is maintained and stored as the desired speed.

It is displayed in the speedometer and briefly displayed in the instrument cluster. Displays in the speedometer, refer to page [125](#).

When cruise control is maintained or stored, DSC Dynamic Stability Control is switched on, if necessary.

Changing/maintaining speed

The rocker switch can be pressed while the system is interrupted in order to maintain and store the current speed.

Adapting the desired speed

Adapt the desired speed to the road conditions and be ready to brake at all times; otherwise, there is the danger of an accident occurring. ◀

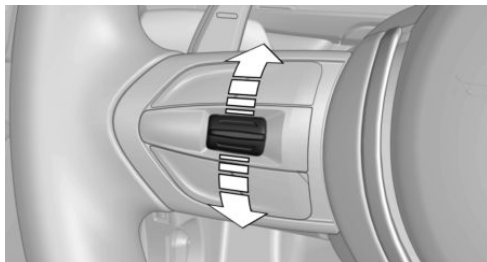

Press the rocker switch up or down repeatedly until the desired speed is set.

If active, the displayed speed is stored and the vehicle reaches the stored speed if the road is clear.

- ▷ Each time the rocker switch is pressed to the point of resistance, the desired speed increases or decreases by approx. 1 mph/1 km/h.
- ▷ Each time the rocker switch is pressed past the point of resistance, the desired speed increases or decreases by a maximum of 5 mph/10 km/h.
Max. adjustable speed: 140 mph/230 km/h.
- ▷ Pressing the rocker switch to the resistance point and holding it there accelerates or decelerates the vehicle without requiring pressure on the accelerator. After the rocker switch is released, the vehicle maintains its final speed. Pressing the switch beyond the resistance point causes the vehicle to accelerate more rapidly.

Resuming the desired speed

 Press the button.

The stored speed is reached and maintained.

Displays in the instrument cluster

Indicator lamp



Depending on how the vehicle is equipped, the indicator lamp in the instrument cluster indicates whether the system is switched on.

Desired speed



- ▶ The marking lights up green: the system is active.
- ▶ The marking lights up orange: the system has been interrupted.
- ▶ The marking does not light up: the system is switched off.

Brief status display



Selected desired speed.

If --- appears briefly on the display for Check Control messages, it is possible that the system requirements for operation are currently not met.

PDC Park Distance Control

The concept

PDC supports you when parking. Objects that you are approaching slowly in front of or behind your vehicle are indicated by:

- ▶ Signal tones.
- ▶ Visual display.

General information

Measurements are made by ultrasound sensors in the bumpers.

The range is approx. 6 ft/2 m.

An acoustic warning is first given:

- ▶ By the front sensors and the two rear corner sensors at approx. 24 in/60 cm.
- ▶ By the rear middle sensors at approx. 5 ft/1.50 m.

Notes



Check the traffic situation as well

PDC cannot serve as a substitute for the driver's personal judgment of the traffic situation. Check the traffic situation around the vehicle with your own eyes. Otherwise, an accident could result from road users or objects located outside of the PDC detection range.

Loud noises from outside and inside the vehicle may prevent you from hearing the PDC's signal tone. ◀



Avoid driving quickly with PDC

Avoid approaching an object quickly.

Avoid driving away quickly while PDC is not yet active.

For technical reasons, the system may otherwise be too late in issuing a warning. ◀

At a glance

Button in the vehicle



PDC Park Distance Control

Switching on/off

Switching on automatically

Select transmission position R with the engine running.

Automatic deactivation during forward travel

The system switches off when a certain driving distance or speed is exceeded.

Switch the system back on if necessary.

Switching on/off manually



Press the button.

- ▷ On: the LED lights up.
- ▷ Off: the LED goes out.

In addition to the PDC Park Distance Control, the rearview camera, refer to page 127, can be switched on.

Switching on the rearview camera via the iDrive

With PDC activated or Top View switched on:

 "Rear view camera"

The rearview camera image is displayed. The setting is stored for the remote control currently in use.

Display

Signal tones

When approaching an object, an intermittent tone is sounded that indicates the position of the object. For example, if an object is detected to the left rear of the vehicle, a signal tone sounds from the left rear speaker.

The shorter the distance to the object becomes, the shorter the intervals.

If the distance to a detected object is less than approx. 10 in/25 cm, a continuous tone is sounded.

If objects are located both in front of and behind the vehicle, an alternating continuous signal is sounded.

The intermittent tone is interrupted after approx. 3 seconds:

- ▷ If the vehicle stops in front of an object that is detected by only one of the corner sensors.
- ▷ If moving parallel to a wall.

The signal tone is switched off:

- ▷ When the vehicle moves away from an object by more than approx. 4 in/10 cm.

Volume

The volume of the PDC signal can be adjusted, refer to user's manual for Navigation, Entertainment, Communication.

The setting is stored for the remote control currently in use.

Visual warning

The approach of the vehicle to an object can be shown on the Control Display. Objects that are farther away are displayed on the Control Display before a signal tone sounds.

A display appears as soon as Park Distance Control (PDC) is activated.

The range of the sensors is represented in the colors red, green and yellow.

If the rearview camera image was selected last, it again appears on the display. To switch to PDC:

1.  "Rear view camera" Select the symbol on the Control Display.
2. Press the controller.

The setting is stored for the remote control currently in use.

System limits

Limits of ultrasonic measurement

The detection of objects can reach the physical limits of ultrasonic measurement, e.g.:

- ▷ With tow bars and trailer hitches.
- ▷ With thin or wedge-shaped objects.
- ▷ With low objects.
- ▷ With objects with corners and sharp edges.

Low objects already displayed, e.g., curbs, can move into the blind area of the sensors before or after a continuous tone sounds.

High, protruding objects such as ledges may not be detected.

False warnings

PDC may issue a warning under the following conditions even though there is no obstacle within the detection range:

- ▷ In heavy rain.
- ▷ When sensors are very dirty or covered in ice.
- ▷ When sensors are covered in snow.
- ▷ On rough road surfaces.
- ▷ In large buildings with right angles and smooth walls, e.g., in underground garages.
- ▷ In heavy exhaust.
- ▷ Due to other ultrasound sources, e.g., sweeping machines, high pressure steam cleaners or neon lights.

Malfunction

A Check Control message is displayed.

The range of the sensors is shown as a shaded area on the Control Display.

PDC has failed. Have the system checked.

To ensure full operability:

- ▷ Keep the sensors clean and free of ice.

- ▷ When using high-pressure washers, do not spray the sensors for long periods and maintain a distance of at least 12 in/30 cm.

Surround View

The concept

Surround View comprises various camera assistance systems that help the driver when parking, maneuvering, and at complex exits and intersections.

- ▷ Rearview camera, refer to page [127](#)
- ▷ Side View, refer to page [132](#).
- ▷ Top View, refer to page [130](#).

Backup camera

The concept

The backup camera provides assistance in parking and maneuvering backwards. The area behind the vehicle is shown on the Control Display.

Hints



Check the traffic situation as well

Check the traffic situation around the vehicle with your own eyes. Otherwise, an accident could result from road users or objects located outside the picture area of the backup camera. ◀

At a glance

Button in the vehicle



 Rearview camera

Camera



The camera lens is located under the BMW emblem of the trunk lid. The image quality may be impaired by dirt. The camera calibrates itself regularly after the system has been switched off. This is why the emblem on the tailgate remains open after the system has been deactivated and while driving. The emblem closes automatically as soon as calibration is complete.

Clean the lens, refer to page [200](#).

Switching on/off

Switching on automatically

Select transmission position R with the engine running.

The backup camera image is displayed if the system was switched on via the iDrive.

Automatic deactivation during forward travel

The system switches off when a certain driving distance or speed is exceeded.

Switch the system back on if necessary.

Switching on/off manually



Press the button.

- ▷ On: the LED lights up.
- ▷ Off: the LED goes out.

The PDC is shown on the Control Display.

Switching on the rearview camera via the iDrive

With PDC activated or Top View switched on:

 "Rear view camera"

The rearview camera image is displayed. The setting is stored for the remote control currently in use.



Display on the Control Display

Functional requirement

- ▷ The rearview camera is switched on.
- ▷ The trunk lid is fully closed.

Activating the assistance functions

More than one assistance function can be active at the same time.

- ▷ Parking aid lines
 -  "Parking aid lines"
 Pathway and turning circle lines are displayed.
- ▷ Obstacle marking
 -  "Obstacle marking"
 Spatially-shaped markings are displayed.

Pathway lines

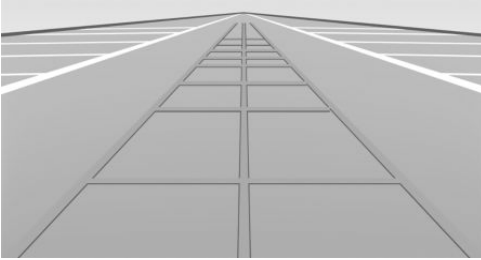

- ▶ Can be shown in the rearview camera image when in transmission position R.
- ▶ Help you to estimate the space required when parking and maneuvering on level roads.
- ▶ Are dependent on the current steering angle and are continuously adjusted to the steering wheel movements.

Turning circle lines

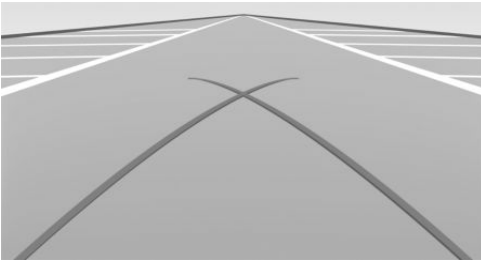

- ▶ Can be shown in the rearview camera image.
- ▶ Show the course of the smallest possible turning circle on a level road.
- ▶ Only one turning circle line is displayed when the steering wheel is turned.

Obstacle marking

General information

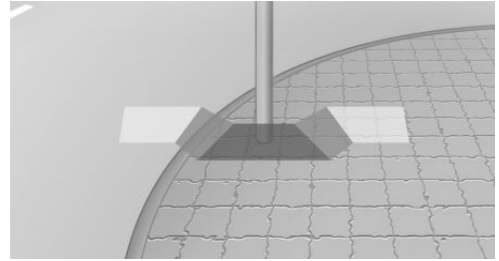

- ▶ Spatially-shaped markings can be shown in the rearview camera image.

Their colored steps match the markings of the PDC. This simplifies estimation of the distance to the object shown.

Parking using pathway and turning circle lines

1. Position the vehicle so that the turning circle lines lead to within the limits of the parking space.

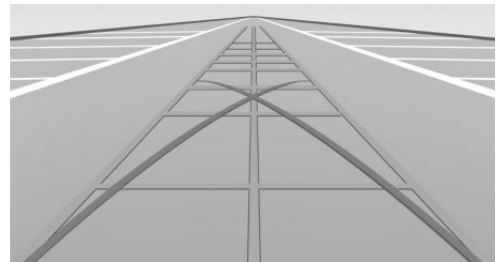

- Turn the steering wheel to the point where the pathway line covers the corresponding turning circle line.

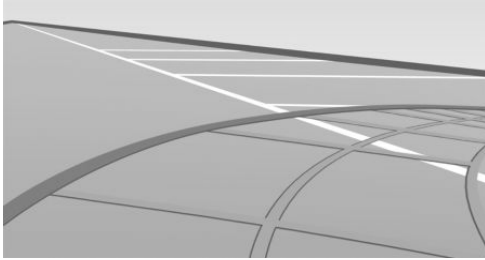

Display settings

Brightness

With the rearview camera switched on:

-  Select the symbol.
- Turn the controller until the desired setting is reached, and press the controller.

Contrast

With the rearview camera switched on:

-  Select the symbol.
- Turn the controller until the desired setting is reached, and press the controller.

System limits

Detection of objects

High, protruding objects such as ledges may not be detected by the rearview camera.

Top View

The concept

Top View assists you in parking and maneuvering. The area around the doors and the road area around the vehicle are shown on the Control Display for this purpose.

General information

The image is captured by two cameras integrated in the exterior mirrors and by the backup camera.

The range is at least 7 ft/2 m to the side and rear.

In this way, obstacles up to the height of the exterior mirrors are detected early.

Notes



Check the traffic situation as well

Check the traffic situation around the vehicle with your own eyes. Otherwise, an accident could result from road users or objects located outside the picture area of the cameras. ◀

At a glance

Button in the vehicle



Top View

Cameras

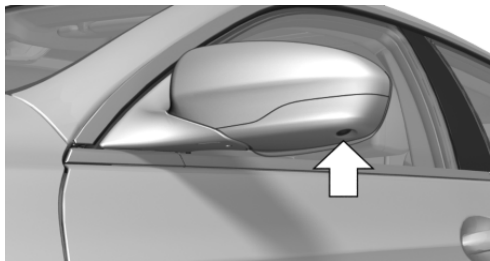

The lenses of the Top View cameras are located at the bottom of the exterior mirror housings. The image quality may be impaired by dirt.

Clean the lens, refer to page 200.

Switching on/off

Switching on automatically

Select transmission position R with the engine running.

The Top View and PDC images are displayed if the system is switched on via iDrive.

Automatic deactivation during forward travel

The system switches off when a certain driving distance or speed is exceeded.

Switch the system back on if necessary.

Switching on/off manually



Press the button.

- ▶ On: the LED lights up.
- ▶ Off: the LED goes out.

Top View is displayed.

Switching on the backup camera via the iDrive

With Top View switched on:

 "Rear view camera"

The backup camera image is displayed. The setting is stored for the remote control currently in use.

Display

Visual warning

The approach of the vehicle to an object can be shown on the Control Display.

When the distance to an object is small, a red bar is shown in front of the vehicle, as it is in the PDC display.

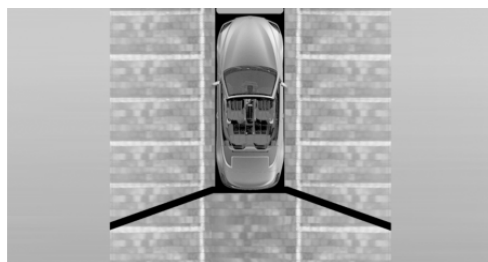

The display appears as soon as Top View is activated.

If the rearview camera image was selected last, it again appears on the display when reverse gear is selected. To switch to Top View:

 "Rear view camera" Select the symbol on the Control Display.

The setting is stored for the remote control currently in use.

Brightness

With Top View switched on:

1.  Select the symbol.
2. Turn the controller until the desired setting is reached, and press the controller.

Contrast

With Top View switched on:

1.  Select the symbol.
2. Turn the controller until the desired setting is reached, and press the controller.

Displaying the turning circle and pathway lines

- ▷ The static, red turning circle line shows the space needed to the side of the vehicle when the steering wheel is turned all the way.
- ▷ The variable, green pathway line assists you in assessing the amount of space actually needed to the side of the vehicle.
The pathway line is dependent on the current steering angle and is continuously adjusted with the steering wheel movement.

"Parking aid lines"

Turning circle and pathway lines are displayed.

System limits

Top View cannot be used in the following situations:

- ▷ With a door open.
- ▷ With the trunk lid open.
- ▷ With an exterior mirror folded in.
- ▷ In poor light.

A Check Control message is displayed in some of these situations.

Side View

The concept

Side View provides an early look at cross traffic at blind driveways and intersections. Road users concealed by obstacles to the left and right of the vehicle can only be detected relatively late from the driver's seat. To improve visibility, two cameras in the front of the vehicle record the traffic situation on each side.

Notes

The images from both cameras are shown simultaneously on the Control Display.



Check the traffic situation as well

Check the traffic situation around the vehicle on blind driveways and intersections with your own eyes. Otherwise, an accident could result from road users or objects located outside the picture area of the Side View cameras. ◀

At a glance

Button in the vehicle



Side View

Cameras

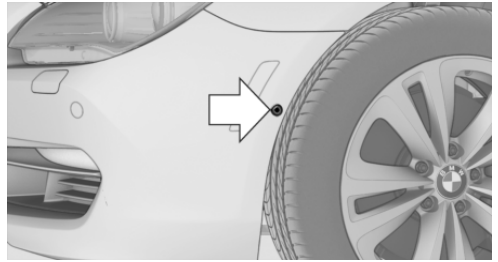

Two cameras integrated in the bumpers capture the image.

The two camera lenses are located on the sides of the bumper.

The image quality may be impaired by dirt.

Clean the lens, refer to page [200](#).

Switching on/off

Switching on/off manually



Press the button.

Automatic deactivation during forward travel

The system switches off when a certain driving distance or speed is exceeded.

Switch the system back on if necessary.

Display

The traffic area to the left and right is displayed on the Control Display.

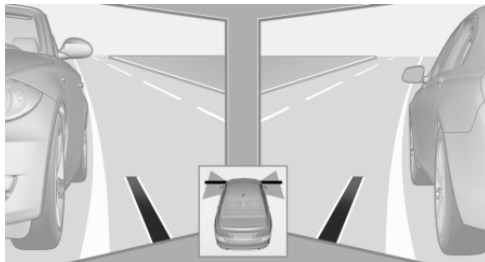

Guidelines at the bottom of the image show the position of the front of the vehicle.

Brightness

With the Side View switched on:

1. ☀ "Brightness"
2. Turn the controller until the desired setting is reached, and press the controller.

Contrast

With the Side View switched on:

1. ● "Contrast"
2. Turn the controller until the desired setting is reached, and press the controller.

System limits

The cameras capture a maximum range of 330 ft/100 m.

Head-up Display

The concept

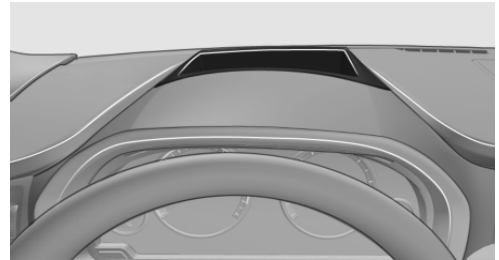

This system projects important information into the driver's field of vision, e.g., the speed. In this way, the driver can get information without averting his or her eyes from the road.

Display visibility

The visibility of the displays in the Head-up Display is influenced by:

- ▷ Certain sitting positions.
- ▷ Objects on the cover of the Head-up Display.
- ▷ Sunglasses with certain polarization filters.
- ▷ Wet roads.
- ▷ Unfavorable light conditions.

If the image is distorted, check the basic settings.

Switching on/off



Press the button.

Display

Standard view

- ▷ Speed.
- ▷ Navigation system.
- ▷ Check Control messages.
- ▷ Speed limit detection.
- ▷ Cruise control.
- ▷ Pedestrian warning.
- ▷ Selection list from the instrument cluster.

Some of this information is only displayed briefly as needed.

M view



- 1 Current engine speed, highlighted
- 2 Shift Lights
- 3 Pre-warning field, speed display
- 4 Red warning field, speed display

- 5 Speed
- 6 Gear display/warning messages

Activate M view:

Select displays in the Head-up Display.

Selecting displays in the Head-up Display

1. "Settings"
2. "Head-Up Display"
3. "Displayed information"
4. Select the desired displays in the Head-up Display.

The settings are stored for the remote control currently in use.

Setting the brightness

The brightness is automatically adjusted to the ambient light.

The basic setting can be adjusted manually.

1. "Settings"
2. "Head-Up Display"
3. "Brightness"
4. Turn the controller.

When the low beams are switched on, the brightness of the Head-up Display can be additionally influenced using the instrument lighting.

The setting is stored for the remote control currently in use.

Adjusting the height

1. "Settings"
2. "Head-Up Display"
3. "Height"
4. Turn the controller.

The setting is stored for the remote control currently in use.

Setting the rotation

1. "Settings"
2. "Head-Up Display"
3. "Rotation"
4. Turn the controller.

The setting is stored for the remote control currently in use.

Special windshield

The windshield is part of the system.

The shape of the windshield makes it possible to display a precise image.

A film in the windshield prevents double images from being displayed.

Therefore, have the special windshield replaced by a service center only.

Climate control

Vehicle equipment

All standard, country-specific and optional equipment that is offered in the model series is described in this chapter. Therefore, equip-

ment is also described that is not available in a vehicle, e. g., because of the selected optional equipment or country variant. This also applies for safety-related functions and systems.

Automatic climate control

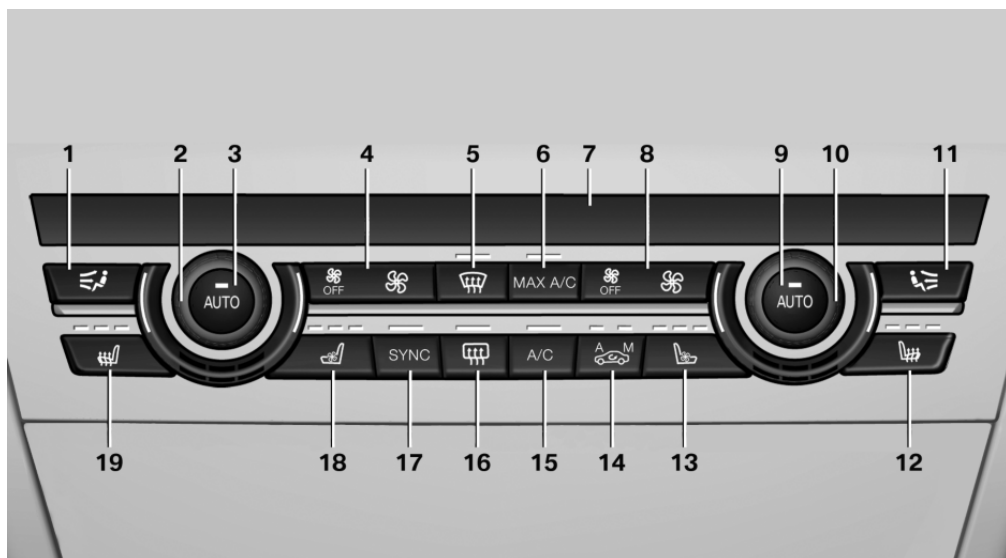

- | | |
|---|---|
| 1 Air distribution, left | 11 Air distribution, right |
| 2 Temperature, left | 12 Seat heating, right 53 |
| 3 AUTO program, left | 13 Active seat ventilation, right 53 |
| 4 Air flow, AUTO intensity, left, residual heat | 14 Automatic recirculated-air control/recirculated-air mode |
| 5 Remove ice and condensation | 15 Cooling function |
| 6 Maximum cooling | 16 Rear window defroster |
| 7 Display | 17 SYNC program |
| 8 Air volume, AUTO intensity, right | 18 Active seat ventilation, left 53 |
| 9 AUTO program, right | 19 Seat heating, left 53 |
| 10 Temperature, right | |

Climate control functions in detail

Manual air distribution



Press the button repeatedly to select a program:

- ▷ Upper body region.
- ▷ Upper body region and footwell.
- ▷ Footwell.
- ▷ Windows and footwell.
- ▷ Windows, upper body region, and footwell.
- ▷ Windows: driver's side only.
- ▷ Windows and upper body region.

If the windows are fogged over, press the AUTO button on the driver's side to utilize the condensation sensor.

Temperature



Turn the wheel to set the desired temperature.

The automatic climate control achieves this temperature as quickly as possible, if necessary with the maximum cooling or heating capacity, and then keeps it constant.

Avoid rapidly switching between different temperature settings. Otherwise, the automatic climate control will not have sufficient time to adjust the set temperature.

AUTO program



Press the button.

Air volume, air distribution, and temperature are controlled automatically.

Depending on the selected temperature, the AUTO intensity, and outside influences, the air is directed to the windshield, side windows, upper body, and into the footwell.

The cooling function, refer to page 138, is switched on automatically with the AUTO program.

At the same time, a condensation sensor controls the program so as to prevent window condensation as much as possible.

Intensity of the AUTO program

With the AUTO program switched on, automatic control of the air flow and air distribution can be adjusted.



Press the left or right side of the button: decrease or increase the intensity.

The selected intensity is shown on the display of the automatic climate control.

Convertible program

When the convertible top is open, the convertible program is activated as well. In the convertible program, the automatic climate control is optimized for driving with the convertible top open. In addition, the air flow is increased as the vehicle speed increases.

The efficiency of the convertible program can be greatly enhanced by installing the wind deflector.

Air flow, manual

To be able to manually adjust the air flow, switch off the AUTO program first.



Press the left or right side of the button: decrease or increase air flow.

The selected air flow is shown on the display of the automatic climate control.

The air flow of the automatic climate control may be reduced automatically to save battery power.

Defrosting windows and removing condensation



Press the button.

Ice and condensation are quickly removed from the windshield and the front side windows.

The air volume can be adjusted when the program is active.

If the windows are fogged over, you can also switch on the cooling function or press the AUTO button to utilize the condensation sensor.

Maximum cooling



Press the button.

The system is set to the lowest temperature, maximum air flow and air circulation mode.

Air flows out of the vents for the upper body region. The vents need to be open for this.

Air is cooled as quickly as possible:

- ▷ At an external temperature of approx. 32 °F/0 °C.
- ▷ When the engine is running.

The air volume can be adjusted when the program is active.

Automatic recirculated-air control/ recirculated-air mode

You can respond to unpleasant odors or pollutants in the immediate environment by temporarily suspending the supply of outside air. The system then recirculates the air currently within the vehicle.



Press the button repeatedly to select an operating mode:

- ▷ LEDs off: outside air flows in continuously.
- ▷ Left LED on, automatic recirculated-air control: a sensor detects pollutants in the

outside air and controls the shutoff automatically.

- ▷ Right LED on, recirculated-air mode: the supply of outside air into the vehicle is permanently blocked.

If the windows are fogged over, switch off the recirculated-air mode and press the AUTO button on the driver's side to utilize the condensation sensor. Make sure that air can flow onto the windshield.



Continuous recirculated-air mode

The recirculated-air mode should not be used for an extended period of time, as the air quality inside the vehicle deteriorates steadily. ◀

Cooling function

The passenger compartment can only be cooled with the engine running.



Press the button.

The air is cooled and dehumidified and – depending on the temperature setting – warmed again.

Depending on the weather, the windshield may fog up briefly when the engine is started.

The cooling function is switched on automatically with the AUTO program.

When using the automatic climate control, condensation water, refer to page 157, develops that exits underneath the vehicle.

Rear window defroster



Press the button.

The rear window defroster switches off automatically after a certain period of time.

The rear window defroster is only active when the rear window is closed.

SYNC program



Press the button.

Current settings on the driver's side for the temperature, air volume, air distribution, and AUTO program are transferred to the front passenger side.

The program is switched off if the settings on the front passenger side are changed.

Residual heat

The heat stored in the engine is used to heat the interior.

Functional requirement

- ▶ Up to 20 minutes after the engine has been switched off.
- ▶ Warm engine.
- ▶ The battery is sufficiently charged.
- ▶ External temperature below 77 °F/25 °C.

Switching on

1. Switch off the ignition.

2.  Press the right side of the button on the driver's side.

⏏ The symbol appears on the automatic climate Control Display.

The interior temperature, air volume and air distribution can be adjusted with the ignition switched on.

Switching off

At the lowest fan speed, press the left side of the button on the driver's side.

⏏ The symbol on the display of the automatic climate control flashes.

Switching the system on/off

Switching off

- ▶ Complete system:



Press and hold the left button on the driver's side until the control clicks off.

- ▶ On the front passenger side:



Press and hold the left button on the front passenger side.

Switching on

Press any button except:

- ▶ SYNC program.
- ▶ Rear window defroster.
- ▶ Left side of Air volume button.
- ▶ Seat heating.
- ▶ Seat ventilation.

Microfilter/activated-charcoal filter

The microfilter removes dust and pollen from the incoming air.

The activated-charcoal filter removes gaseous pollutants from the outside air that enters the vehicle.

This combined filter should be replaced during scheduled maintenance, refer to page 182, of your vehicle.

Ventilation

Front ventilation

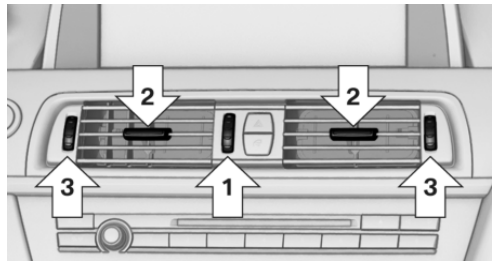

- ▶ Thumbwheel to vary the temperature, arrow 1.
Toward blue: colder.
Toward red: warmer.
- ▶ Lever for changing the air flow direction, arrow 2.

- ▶ Thumbwheels for opening and closing the vents continuously, arrows 3.

Adjusting the ventilation

- ▶ Ventilation for cooling:
Adjust the vent to direct the air in your direction, e.g., if the vehicle interior is hot from the sun.
- ▶ Draft-free ventilation:
Adjust the vent to let the air flow past you.

Parked-car ventilation

The concept

The parked-car ventilation ventilates the vehicle interior and lowers its temperature, if necessary.

The switch-on time is automatically determined based on the temperature. The system promptly switches on before the selected departure time.

The system can be switched on and off directly or by using two preset switch-on times. It remains switched on for 30 minutes.

The system can be switched on and off directly or by using two preset departure times. Operation can be performed via iDrive.

Functional requirements

Parked-car ventilation

- ▶ Using the preset departure time or when operated directly: any external temperature.

Open the vents to allow air to flow out.

Switching on/off directly

1. "Settings"
2. "Climate"
3. "Activate comf. ventilation"

- ⚙ The symbol on the automatic climate control flashes if the system is switched on.

The system continues to run for some time after being switched off.

Preselecting the departure time

1. "Settings"
2. "Climate"
3. "Dep. time 1:" or "Dep. time 2:"
4. Set the desired time.

Activating the departure time

1. "Settings"
2. "Climate"
3. "Activate depart. time 1" or "Activate depart. time 2"

- ⚙ The symbol on the automatic climate control lights up when the departure time is activated.

- ⚙ The symbol on the automatic climate control flashes when the system has been switched on.

The system will only be switched on within the next 24 hours. After that, it needs to be reactivated.

Interior equipment

Vehicle equipment

All standard, country-specific and optional equipment that is offered in the model series is described in this chapter. Therefore, equipment is also described that is not available in a vehicle, e. g., because of the selected optional equipment or country variant. This also applies for safety-related functions and systems.

Integrated universal remote control

The concept

The integrated universal remote control can operate up to 3 functions of remote-controlled systems such as garage door drives or lighting systems. The integrated universal remote control replaces up to 3 different hand-held transmitters. To operate the remote control, the buttons on the interior rearview mirror must be programmed with the desired functions. The hand-held transmitter for the particular system is required in order to program the remote control.

 During programming

During programming and before activating a device using the integrated universal remote control, ensure that there are no people, animals, or objects in the range of movement of the remote-controlled device; otherwise, there is a risk of injury or damage.

Also follow the safety instructions of the hand-held transmitter. ◀

Before selling the vehicle, delete the stored functions for the sake of security.

Compatibility



If this symbol is printed on the packaging or in the instructions of the system to be controlled, the system is generally compatible with the integrated universal remote control.

If you have any questions, please contact:

- ▷ Your service center.
- ▷ www.homelink.com on the Internet.

HomeLink is a registered trademark of Johnson Controls, Inc.

Controls on the interior rearview mirror

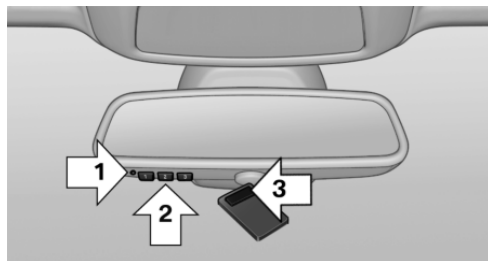

- ▷ LED, arrow 1.
- ▷ Buttons, arrow 2.
- ▷ The hand-held transmitter, arrow 3, is required for programming.

Programming

General information

1. Switch on the ignition.
2. Initial setup:

Press and hold the left and right button on the interior rearview mirror simultaneously for approximately 20 seconds until the LED on the interior rearview mirror flashes. This

erases all programming of the buttons on the interior rearview mirror.

3. Hold the hand-held transmitter for the system to be controlled approx. 1 to 3 in/2.5 to 8 cm away from the buttons on the interior rearview mirror. The required distance depends on the manual transmitter.
4. Simultaneously press and hold the button of the desired function on the hand-held transmitter and the button to be programmed on the interior rearview mirror. The LED on the interior rearview mirror will begin flashing slowly.
5. Release both buttons as soon as the LED flashes more rapidly. When the LED is flashing faster, this indicates that the button on the interior rearview mirror has been programmed.

If the LED does not flash faster after at least 60 seconds, change the distance between the interior rearview mirror and the hand-held transmitter and repeat the step. Several more attempts at different distances may be necessary. Wait at least 15 seconds between attempts.

Canada: if programming with the hand-held transmitter was interrupted, hold down the interior rearview mirror button and repeatedly press and release the hand-held transmitter button for 2 seconds.

6. To program other functions on other buttons, repeat steps 3 to 5.

The systems can be controlled using the interior rearview mirror buttons.

Special feature of the alternating-code wireless system

If you are unable to operate the system after repeated programming, please check if the system to be controlled features an alternating-code system.

Read the system's operating manual, or press the programmed button on the interior rear-

view mirror longer. If the LED on the interior rearview mirror starts flashing rapidly and then stays lit constantly for 2 seconds, the system features an alternating-code system. Flashing and continuous illumination of the LED will repeat for approximately 20 seconds.

For systems with an alternating-code system, the integrated universal remote control and the system also have to be synchronized.

Please read the operating manual of the system being set up for information on how to synchronize the system.

Synchronizing is easier with the aid of a second person.

To synchronize:

1. Park the vehicle within range of the remote-controlled system.
2. Program the relevant button on the interior rearview mirror as described.
3. Locate and press the synchronizing button on the system being programmed. You have approx. 30 seconds for the next step.
4. Hold down the programmed button on the interior rearview mirror for approximately 3 seconds and then release it. If necessary, repeat this work step up to three times in order to finish synchronization. Once synchronization is complete, the programmed function will be carried out.

Reprogramming individual buttons

1. Switch on the ignition.
2. Press and hold the interior rearview mirror button to be programmed.
3. As soon as the interior rearview mirror LED starts flashing slowly, hold the hand-held transmitter for the system to be controlled approx. 1 to 3 in/2.5 to 8 cm away from the buttons on the interior rearview mirror. The required distance depends on the manual transmitter.

4. Likewise, press and hold the button of the desired function on the hand-held transmitter.
5. Release both buttons as soon as the interior rearview mirror LED flashes more rapidly. When the LED is flashing faster, this indicates that the button on the interior rearview mirror has been programmed. The system can then be controlled by the button on the interior rearview mirror.

If the LED does not flash faster after at least 60 seconds, change the distance and repeat the step. Several more attempts at different distances may be necessary. Wait at least 15 seconds between attempts.

Canada: if programming with the hand-held transmitter was interrupted, hold down the interior rearview mirror button and repeatedly press and release the hand-held transmitter button for 2 seconds.

Controls



Before operation

Before operating a system using the integrated universal remote control, ensure that there are no people, animals, or objects within the range of movement of the remote-controlled system; otherwise, there is a risk of injury or damage.

Also follow the safety instructions of the hand-held transmitter. ◀

The system, such as the garage door, can be operated using the button on the interior rearview mirror while the engine is running or when the ignition is started. To do this, hold down the button within receiving range of the system until the function is activated. The interior rearview mirror LED stays lit while the wireless signal is being transmitted.

Deleting stored functions

Press and hold the left and right button on the interior rearview mirror simultaneously for ap-

proximately 20 seconds until the LED flashes rapidly. All stored functions are deleted. The functions cannot be deleted individually.

Ashtray/cigarette lighter

Manual-shift transmission: opening



Press on the cover.

Open



Press the button.

Emptying

Take out the insert.

Lighter



Push in the lighter.

The lighter can be removed as soon as it pops back out.

**Danger of burns**

Only hold the hot lighter by its knob; otherwise, there is the danger of getting burned.

Switch off the ignition and take the remote control with you when leaving the vehicle so that children cannot use the lighter and burn themselves. ◀

**Replace the cover after use**

Reinsert the lighter or socket cover after use, otherwise objects may get into the lighter socket or fixture and cause a short circuit. ◀

Connecting electrical devices

Hints



Do not plug chargers into the socket

Do not connect battery chargers to the factory-installed sockets in the vehicle as this may damage the battery. ◀

**Replace the cover after use**

Reinsert the lighter or socket cover after use, otherwise objects may get into the lighter socket or fixture and cause a short circuit. ◀

Sockets

The lighter socket can be used as a socket for electrical equipment while the engine is running or when the ignition is switched on. The total load of all sockets must not exceed 140 watts at 12 volts.

Do not damage the socket by using unsuitable connectors.

Manual transmission: center console

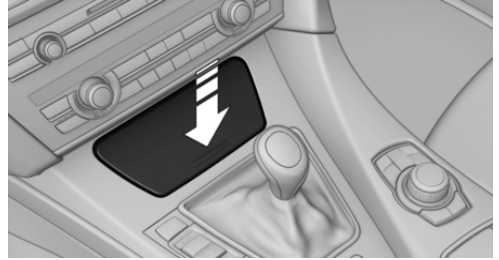

Press on the cover.

Remove the cover or cigarette lighter.

Center console



Press the button.

Remove the cover or cigarette lighter.

In the front passenger footwell

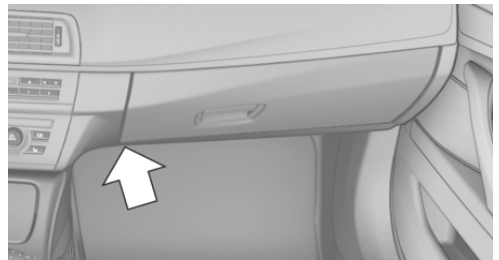

Socket is located below the glove compartment.

To access the socket: fold open the cover.

Center armrest

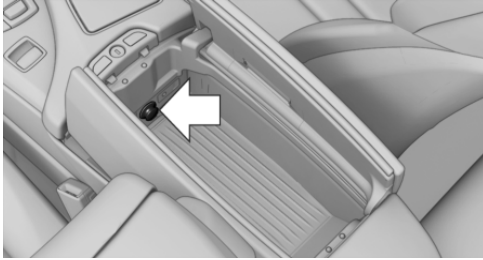

Remove the cover.

Ski bag

Capacity

The ski bag makes it possible to transport two pairs of skis up to a length of 6 ft/2.10 m.

Preparing and loading the ski bag

1. Pull the release in the direction of the arrow, and remove the insert from the front. If necessary, when pulling the release, press against the insert.



2. Lay out the ski bag.

3. Press button in the cargo area, open tail-board and attach to the rear wall via magnetic holder.

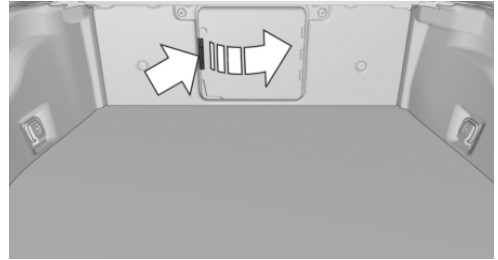

4. Load the ski bag. If necessary, wrap the sharp edges of the skis.
5. Tighten the retaining strap.

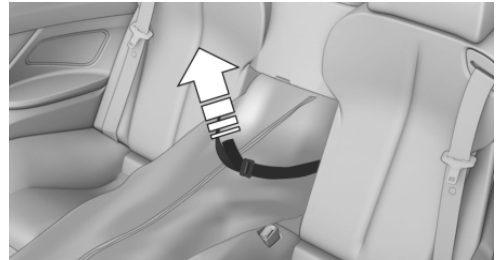

Securing the ski bag

Secure the ski bag by tightening the retaining strap; otherwise, the contents could present a source of danger to the passengers, for example during braking or evasive maneuvers. ◀

Stowing the ski bag

Proceed in the reverse order of loading.

When replacing the insert, place both pins into the rail at the bottom and press the insert back in place until a 'click' is heard. Ensure that the rear seat backrest upholstery is not damaged.

Storage compartments

Vehicle equipment

All standard, country-specific and optional equipment that is offered in the model series is described in this chapter. Therefore, equipment is also described that is not available in a vehicle, e. g., because of the selected optional equipment or country variant. This also applies for safety-related functions and systems.

Notes

 No loose objects in the passenger compartment

Do not stow any objects in the passenger compartment without securing them; otherwise, they may present a danger to occupants for instance during braking and avoidance maneuvers. ◀

 Do not place anti-slip mats on the dashboard

Do not place anti-slip mats on the dashboard. The mat materials could damage the dashboard. ◀

Storage compartments

The following storage compartments are available in the vehicle interior:

- ▷ Glove compartment on the front passenger side, refer to page 146.
- ▷ Storage compartment on the center console: manual transmission.
- ▷ Storage compartment in the center arm-rest, refer to page 147.
- ▷ Compartments in the doors.
- ▷ Pockets on the backrests of the front seats.
- ▷ Net in the front passenger footwell.

Glove compartment

Note

 Close the glove compartment again immediately

Close the glove compartment immediately after use while driving; otherwise, injury may occur during accidents. ◀

Opening



Pull the handle.

The light in the glove compartment switches on.

Closing

Fold up the cover.

USB interface for data transfer

The concept

Connection for importing and exporting data on USB devices, e.g.:

- ▷ Personal Profile settings, refer to page 31.
- ▷ Music collection, see user's manual for Navigation, Entertainment and Communication.

Without Professional navigation system or TV: at a glance

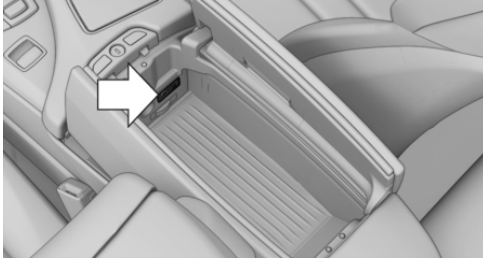

The USB interface is located in the center armrest.

Without Professional navigation system or TV: at a glance

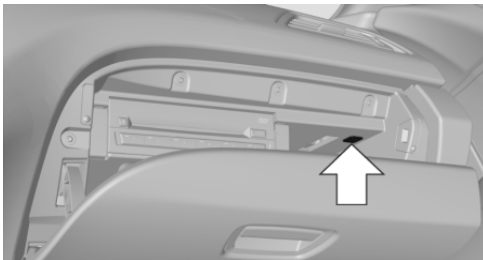

The USB interface is located in the glove compartment.

Notes

Observe the following when connecting:

- Do not use force when plugging the connector into the USB interface.
- Do not connect devices such as fans or lamps to the USB interface.
- Do not connect USB hard drives.
- Do not use the USB interface to recharge external devices.

Front center armrest

Opening

A storage compartment is located in the center armrest between the front seats.

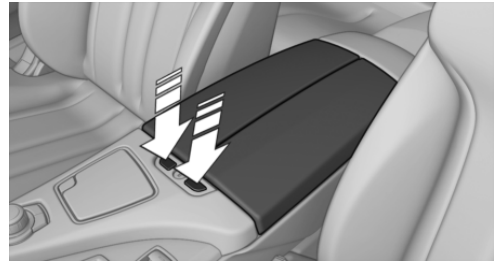

Press the buttons next to the lock.

Locking the storage compartment

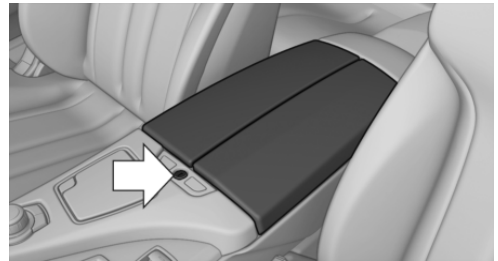

The storage compartment in the armrest can be locked with an integrated key to separately secure the trunk lid, refer to page 37, for example.

After the storage compartment is locked, the remote control can be handed out without the integrated key, refer to page 30, for instance at a hotel.

This prevents access to the storage compartment and to the cargo area.

Connection for an external audio device



Description, see user's manual for Navigation, Entertainment and Communication.

Cupholders

Notes

 Shatter-proof containers and no hot drinks

Use light and shatter-proof containers and do not transport hot drinks. Otherwise, there is the increased danger of injury in an accident. ◀

 Unsuitable containers
Do not forcefully push unsuitable containers into the cupholders. This may result in damage. ◀

Manual transmission: center console



A cupholder is located on the center console.

Manual transmission: center armrest

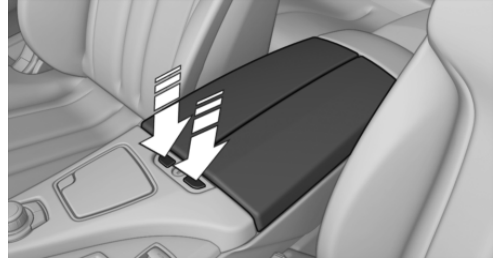

A cupholder is located in the center armrest compartment.

To open: press the buttons next to the lock.

Center console

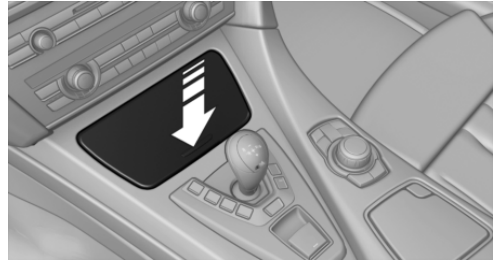

To open: press on the cover.

Storage compartments in the cargo area

Net

Small objects can be stowed in the net on the rear cargo area trim.

Lashing eyes

To secure the cargo, refer to page 159, there are lashing eyes in the cargo area.

Storage compartment under the cargo floor cover



Raise the cargo floor cover using the strap.



Driving tips

This chapter provides you with information useful in dealing with specific driving and operating modes.

BMW M6 technology

Vehicle equipment

All standard, country-specific and optional equipment that is offered in the model series is described in this chapter. Therefore, equipment is also described that is not available in a vehicle, e. g., because of the selected optional equipment or country variant. This also applies for safety-related functions and systems.

V8 high-performance engine

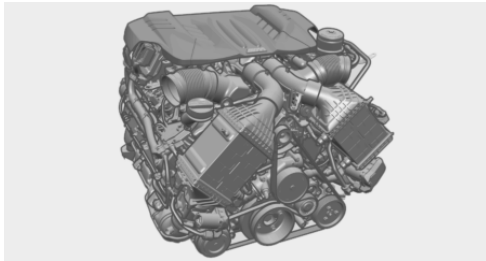

The high-performance V8 engine gets maximum power of 412 kW and maximum torque of 680 Nm from a displacement of 4.4 liters. With its spontaneous response behavior, a speed range of wide utility results. The maximum engine speed is at 7,200 rpm and it electronically controlled. Because of the high engine dynamics, the maximum engine speed with the vehicle stationary is progressively deactivated after a short time.

Warmup

During the engine warmup phase, the V8 high-performance engine has a somewhat rougher running behavior because of the emission controls.

When the engine is cold, the exhaust system has a slightly metallic undertone due to the nature of the system.

For more information about the warmup procedure: Engine speed, refer to page 82, and engine oil temperature, refer to page 82.

Compound brake

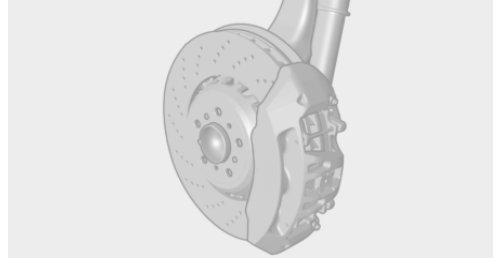

The vehicle has a high-performance brake system with perforated compound brake discs.

Because of particular structural characteristics, there may be operation-related noises during braking. However, this has no effect on performance, operational reliability and reliability of the brake.

Correct braking

To keep the brake system in optimum condition, it is expedient to apply them at regular intervals corresponding to the vehicle character.

M carbon ceramic brake

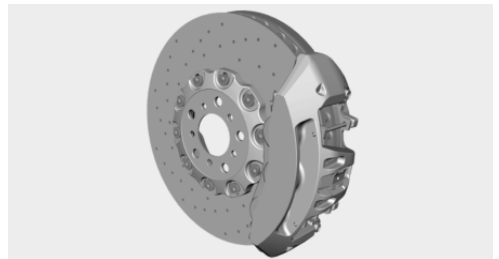

The vehicle is fitted with a high-performance braking system with perforated carbon ce-

ramic brake discs designed for use on race-tracks.

Due to properties of the materials used, braking may be associated with louder function noises, particularly in wet conditions, just before the vehicle comes to a stop. However, this has no effect on the performance, operational reliability and durability of the brake.

The effects of moisture and road salt, from using a carwash or dew formation overnight for example, may render the braking effect comparable to that of a conventional braking system. This may be perceived as reduced braking effect and can be compensated for if necessary by pressing the brake pedal harder.

Before washing the vehicle in an automatic carwash or wash tunnel, clean the brake discs and brake calipers with a steam jet or high-pressure washer as well, to prevent encrustations and dirt build-ups, caused by salt crystals, for example, if the car is immobile afterwards. The cleaning effect of automatic carwashes or wash tunnels is usually not adequate for this in the area around the wheels.

To do this, also follow the instructions in Washing the vehicle, refer to page 196, and Braking safely, refer to page 156.

Drive train

With this vehicle, particular value was placed on the direct connection from engine to the drive train. Due to the torsionally rigid design of the drive train, as is typical in a sports car, the transmission of the torque also gives acoustic feedback.

When there are load changes, this may result in clacker noises. They do not cause any impairment of the operation or the service life of the components.

Driving on racetracks

Requirements

Before driving on a racetrack:

- ▷ Participation in the BMW Driver Training.
- ▷ Check engine oil fill level and replenish as necessary.
- ▷ Have vehicle checked at a service center.

Hints

Racetrack operation leads to increased wear. The vehicle is not designed for motorsports competitive use. This wear is not covered by the warranty.

The standard brake linings and the wear indicators are not designed for racetrack operation. For more information and advice, contact your service center.

Things to remember when driving

Vehicle equipment

All standard, country-specific and optional equipment that is offered in the model series is described in this chapter. Therefore, equipment is also described that is not available in a vehicle, e. g., because of the selected optional equipment or country variant. This also applies for safety-related functions and systems.

Breaking-in period

General information

Moving parts need to be broken in to adjust to each other.

The following instructions will help achieve a long vehicle life and good economy.

During break-in, do not use the Launch Control, refer to page 73.

Engine and differential

Always obey the official speed limit.

Up to 1,200 miles/2,000 km

Drive at varying engine and road speeds, but do not exceed 5,500 rpm and 106 mph/170 km/h.

Avoid full load or kickdown on the accelerator pedal under all circumstances.

At 1,200 miles/2,000 km

Have drive-in checkup maintenance performed.

From 1,200 miles/2,000 km to 3,100 miles/5,000 km

The engine and road speed can gradually be increased to a constant speed of 137 mph/220 km/h.

Use the maximum speed of 155 mph/250 km/h only briefly, e.g., when passing.

Tires

Due to technical factors associated with their manufacture, tires do not achieve their full traction potential until after an initial breaking-in period.

Drive conservatively for the first 200 miles/300 km.

Brake system

M Compound brakes require an initial break-in period of approx. 300 miles/500 km to achieve optimized contact and wear patterns between brake discs and brake pads. Drive moderately during this break-in period.

M carbon ceramic brakes require an initial break-in period of approx. 600 miles/1,000 km to achieve optimized contact and wear patterns between brake discs and brake pads. Drive moderately during this break-in period.

Clutch

The function of the clutch reaches its optimal level only after a distance driven of approx. 300 miles/500 km. During this break-in period, engage the clutch gently.

Following part replacement

The same breaking in procedures should be observed if any of the components mentioned above have to be renewed in the course of the vehicle's operating life.

General driving notes

Closing the trunk lid



Drive with the trunk lid closed

Only drive with the tailgate closed; otherwise, in the event of an accident or braking and evasive maneuvers, passengers and other road users may be injured, and the vehicle may be damaged. In addition, exhaust fumes may enter the passenger compartment. ◀

If driving with the tailgate open cannot be avoided:

- ▶ If the convertible top is closed, close all windows.
- ▶ Greatly increase the blower speed.
- ▶ Drive moderately.

Hot exhaust system



Hot exhaust system

High temperatures are generated in the exhaust system.

Do not remove the heat shields installed and never apply undercoating to them. Make sure that flammable materials, e. g. hay, leaves, grass, etc. do not come in contact with the hot exhaust system during driving, while in idle position mode, or when parked. Such contact could lead to a fire, and with it the risk of serious personal injury as well as property damage.

Do not touch hot exhaust pipes; otherwise, there is the danger of getting burned. ◀

Climate control windshield

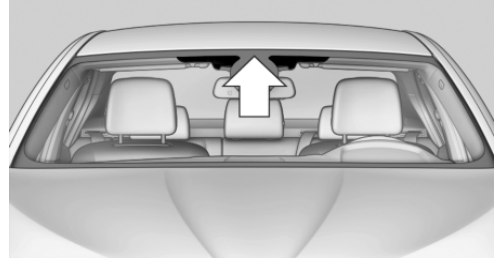

The marked area is not covered with heat reflective coating.

Use this area for garage door openers, devices for electronic toll collection, etc.

Mobile communication devices in the vehicle



Mobile communication devices in the vehicle

It is advised that you do not use mobile communication devices, e.g., mobile phones, inside the vehicle without connecting them directly to the external antenna. Otherwise, the vehicle electronics and mobile communication devices can interfere with each other. In addition, there is no assurance that the radiation generated during transmission will be discharged from the vehicle interior. ◀

Hydroplaning

On wet or slushy roads, a wedge of water can form between the tires and road surface.

This phenomenon is referred to as hydroplaning. It is characterized by a partial or complete loss of contact between the tires and the road surface, ultimately undermining your ability to steer and brake the vehicle.



Hydroplaning

When driving on wet or slushy roads, reduce your speed to prevent hydroplaning. ◀

Driving through water

Drive through calm water only and only if it is not deeper than 9.8 inches/25 cm and at this height, no faster than walking speed, up to 6 mph/10 km/h.

 Adhere to water depth and speed limitations

Do not exceed this water depth and walking speed; otherwise, the vehicle's engine, the electrical systems and the transmission may be damaged. ◀

Braking safely

Your vehicle is equipped with ABS as a standard feature.

Applying the brakes fully is the most effective way of braking in situations when this is necessary.

The vehicle maintains steering responsiveness. You can still avoid any obstacles with a minimum of steering effort.

The pulsing of the brake pedal indicates that ABS is in its active mode.

In certain braking situations, the perforated brake discs can cause functional problems. However, this has no effect on the performance and operational reliability of the brake.

Objects in the area around the pedals

 No objects in the area around the pedals
Keep floor mats, carpets, and any other objects out of the area of motion of the pedals; otherwise, the function of the pedals could be impeded while driving

Do not place additional floor mats over existing mats or other objects.

Only use floor mats that have been approved for the vehicle and can be properly fixed in place.

Ensure that the floor mats are securely fastened again after they were removed for cleaning, for example. ◀

Driving in wet conditions

When roads are wet coated with road salt or there is heavy rain, briefly exert gentle pressure on the brake pedal every few miles.

Ensure that this action does not endanger other road users.

The heat generated in this process helps dry the brake discs and pads.

In this way braking efficiency will be available when you need it.

Hills

Drive long or steep downhill gradients in the gear in which the least braking is required. Otherwise, the brake system may overheat, resulting in a reduction in the brake system efficiency.

Double-clutch transmission:

You can increase the engine's braking effect by shifting down in sequential mode, refer to page 71.

 Avoid load on the brakes
Avoid placing excessive load on the brake system. Light but consistent brake pressure can lead to high temperatures, brake wear and possibly even brake failure. ◀

 Do not drive in neutral
Do not drive in neutral or with the engine stopped, as doing so disables engine braking. In addition, steering and brake assist is unavailable with the engine stopped. ◀

Brake disc corrosion

The corrosion on the brake discs and the contamination on the brake pads are furthered by:

- ▷ Low mileage.
- ▷ Extended periods when the vehicle is not used at all.
- ▷ Infrequent use of the brakes.

Corrosion occurs when the minimum pressure that must be exerted by the pads during brake applications to clean the discs is not reached.

Should corrosion form on the brake discs, the brakes will tend to respond with a pulsating effect that generally cannot be corrected.

Condensation under the parked vehicle

When using the automatic climate control, condensation water develops that exits underneath the vehicle.

Traces of water under the vehicle like this are normal.

Ground clearance



Limited ground clearance

Observe the limited ground clearance of the vehicle, e. g. while entering underground parking garages or when driving over obstacles. Otherwise, damages to the vehicle may result. ◀

To drive down from curbs with the Electronic Damper Control, refer to page 121, select the following program, to keep the ground clearance as even as possible: "Sport Plus"

M Driver's Package: Driving in the higher speed range



Damage to the vehicle

To ensure problem-free driving behavior in the maximum speed range, have any damage to the vehicle repaired as soon as possible as it could negatively impact driving performance. This includes, among other things, tires, undercarriage and parts for improving aerodynamics.

Until the damage is repaired, do not drive the vehicle in the higher speed range; otherwise, there is danger of an accident. ◀

Loading

Vehicle equipment

All standard, country-specific and optional equipment that is offered in the model series is described in this chapter. Therefore, equipment is also described that is not available in a vehicle, e. g., because of the selected optional equipment or country variant. This also applies for safety-related functions and systems.

Hints

 Overloading the vehicle

To avoid exceeding the approved carrying capacity of the tires, never overload the vehicle. Overloading can lead to overheating and increases the rate at which damage develops inside the tires. This could result in a sudden loss of tire inflation pressure. ◀

 No fluids in the trunk

Make sure that fluids do not leak into the trunk; otherwise, the vehicle may be damaged. ◀

Determining the load limit

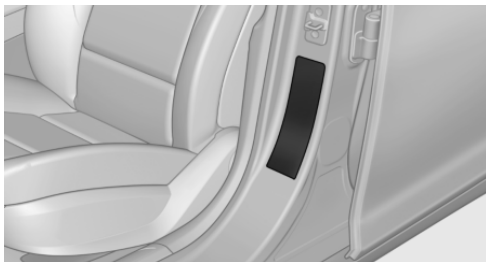

1. Locate the following statement on your vehicle's placard:
 - ▶ The combined weight of occupants and cargo should never exceed XXX kg or YYY lbs. Otherwise, damage to the

vehicle and unstable driving situations may result.

2. Determine the combined weight of the driver and passengers that will be riding in your vehicle.
3. Subtract the combined weight of the driver and passengers from XXX kilograms or YYY pounds.
4. The resulting figure equals the available amount of cargo and luggage load capacity.

For example, if the YYY amount equals 1,000 lbs and there will be four 150 lbs passengers in your vehicle, the amount of available cargo and luggage load capacity is 400 lbs: 1,000 lbs minus 600 lbs = 400 lbs.

5. Determine the combined weight of luggage and cargo being loaded on the vehicle. That weight may not safely exceed the available cargo and luggage load capacity calculated in Step 4.

Load

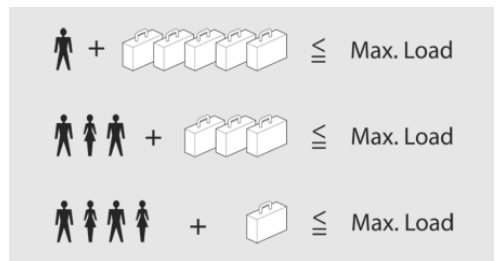

The maximum load is the sum of the weight of the occupants and the cargo.

The greater the weight of the occupants, the less cargo that can be transported.

Stowing cargo

- ▶ Cover sharp edges and corners on the cargo.
- ▶ Heavy cargo: stow as far forward as possible, directly behind and at the bottom of the rear passenger seat backrests.
- ▶ Very heavy cargo: when the rear seat is not occupied, secure each of the outer safety belts in the opposite buckle.

Heavy or hard objects should not be carried loose inside the car; otherwise, they could be thrown around as a result of hard braking, sudden swerves, etc., and endanger the occupants. ◀

Securing cargo

Lashing eyes in the cargo area

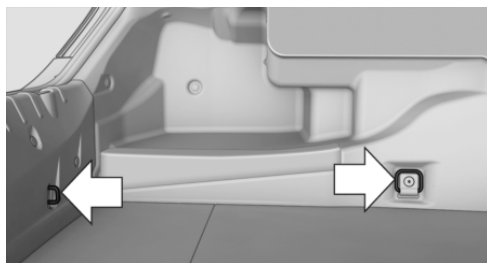

To secure the cargo there are four lashing eyes in the cargo area.

Securing cargo

- ▶ Smaller and lighter items: secure with retaining straps or with a cargo net or draw straps.
- ▶ Larger and heavy objects: secure with cargo straps.

Cargo straps, cargo netting, retaining straps or draw straps on the lashing eyes in the cargo area.



Securing cargo

Always position and secure the cargo as described above; otherwise, it can endanger the car's occupants if sudden braking or swerving becomes necessary.

Saving fuel

Vehicle equipment

All standard, country-specific and optional equipment that is offered in the model series is described in this chapter. Therefore, equipment is also described that is not available in a vehicle, e. g., because of the selected optional equipment or country variant. This also applies for safety-related functions and systems.

General information

Your vehicle contains advanced technology for the reduction of fuel consumption and emissions.

Fuel consumption depends on a number of different factors.

The implementation of certain measures, driving style and regular maintenance can have an influence on fuel consumption and on the environmental impact.

Remove unnecessary cargo

Additional weight increases fuel consumption.

Remove attached parts following use

Attached parts on the vehicle impair the aerodynamics and increase the fuel consumption.

Closing the windows

Open windows increase air resistance and therefore lead to greater fuel consumption.

Tires

General information

Tires can affect fuel consumption values in various ways, for instance fuel consumption can be influenced by the size of the tires.

Check the tire inflation pressure regularly

Check and, if necessary, correct the tire inflation pressure at least twice a month and before starting on a long trip.

Low tire inflation pressure increases rolling resistance and thus raises fuel consumption and tire wear.

Drive away without delay

Do not wait for the engine to warm-up while the vehicle remains stationary. Start driving right away, but at moderate engine speeds.

This is the fastest way for the cold engine to reach its operating temperature.

Look well ahead when driving

Avoid unnecessary acceleration and braking.

By maintaining a suitable distance to the vehicle driving ahead of you.

Driving smoothly and looking ahead reduces fuel consumption.

Avoid high engine speeds

Use 1st gear to get the vehicle in motion. Beginning with 2nd gear, accelerate rapidly. When accelerating, shift up before reaching high engine speeds.

When you reach the desired speed, shift into the highest applicable gear and drive with the engine speed as low as possible and at a constant speed.

As a rule: driving at low engine speeds lowers fuel consumption and reduces wear.

The gear shift indicator of your vehicle indicates the most fuel efficient gear.

Use coasting conditions

When approaching a red light, take your foot off the accelerator and let the vehicle coast to a halt.

On a downhill gradient, take your foot off the accelerator and let the vehicle roll.

The flow of fuel is interrupted while coasting.

Switch off the engine during longer stops

Switch off the engine during longer stops, e.g., at traffic lights, railroad crossings or in traffic congestion.

Automatic Engine Start/Stop Function

The Auto Start/Stop function of your vehicle automatically switches off the engine during a stop.

If the engine is switched off and then restarted rather than leaving the engine running constantly, fuel consumption and emissions are reduced. Savings can begin within a few seconds of switching off the engine.

Using this system can cause certain components of the vehicle to become worn prematurely.

In addition, fuel consumption is also determined by other factors, such as driving style, road conditions, maintenance or environmental factors.

Switch off any functions that are not currently needed

Functions such as seat heating and the rear window defroster require a lot of energy and consume additional fuel, especially in city and stop-and-go traffic.

Therefore, switch off these functions if they are not actually needed.

Have maintenance carried out

Have vehicles maintained regularly to achieve optimal vehicle economy and operating life. Have the maintenance carried out by your service center.

Please also note the BMW Maintenance System, refer to page [182](#).





Mobility

In order to always ensure your mobility, you will find important information on operating fluids, wheels and tires, maintenance and Roadside Assistance in the following.

Refueling

Vehicle equipment

All standard, country-specific and optional equipment that is offered in the model series is described in this chapter. Therefore, equipment is also described that is not available in a vehicle, e. g., because of the selected optional equipment or country variant. This also applies for safety-related functions and systems.

General information

 Refuel promptly

Refuel no later than at a range of 30 miles/50 km, or operation of the engine is not ensured and damage may occur. ◀

Fuel cap

Opening

1. Briefly press the rear edge of the fuel filler flap.



2. Turn the fuel cap counterclockwise.

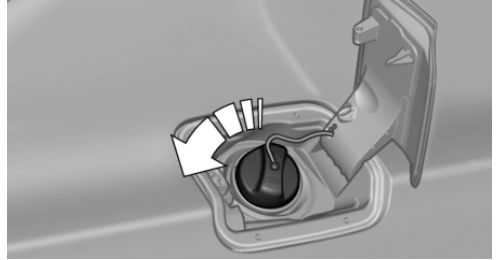

3. Place the fuel cap in the bracket attached to the fuel filler flap.

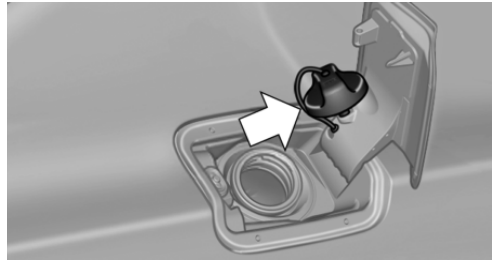

Closing

1. Fit the cap and turn it clockwise until you clearly hear a click.
2. Close the fuel filler flap.



Do not pinch the retaining strap

Do not pinch the retaining strap attached to the cap; otherwise, the cap cannot be closed properly and fuel vapors can escape.

A message is displayed if the cap is loose or missing. ◀

Manually unlocking fuel filler flap

In the event of an electrical malfunction, for example,

1. Open the cover on the right side trim.

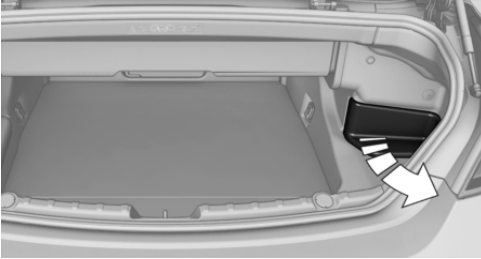

2. Pull the green knob with the fuel pump symbol. This releases the fuel filler flap.

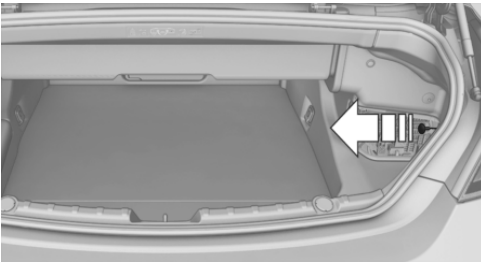

Observe the following when refueling

The fuel tank is full when the filler nozzle clicks off the first time.



Do not overfill the fuel tank

Do not overfill the fuel tank; otherwise fuel may escape, causing harm to the environment and damaging the vehicle. ◀



Handling fuels

Obey safety regulations posted at the gas station. ◀

Fuel

Vehicle equipment

All standard, country-specific and optional equipment that is offered in the model series is described in this chapter. Therefore, equipment is also described that is not available in a vehicle, e. g., because of the selected optional equipment or country variant. This also applies for safety-related functions and systems.

Fuel recommendation

Gasoline

For the best fuel economy, the gasoline should be sulfur-free or very low in sulfur content.

Fuels that are marked on the gas pump as containing metal must not be used.

 Refuel only with unleaded gasoline without metallic additives.

Do not refuel with any leaded gasoline or gasoline with metallic additives, e. g. manganese or iron, or permanent damage to the catalytic converter and other components. ◀

Fuels with a maximum ethanol content of 10 %, i. e., E10, may be used for refueling.

Ethanol should satisfy the following quality standards:

US: ASTM 4806–xx

CAN: CGSB-3.511–xx

xx: comply with the current standard in each case.

 Do not refuel with ethanol E85

Do not refuel with E85, i.e., fuel with an ethanol content of 85 %, or with Flex Fuel, as this would damage the engine and fuel supply system. ◀

Gasoline quality

BMW recommends AKI 93.

Minimum fuel grade

BMW recommends AKI 91.

 Minimum fuel grade

Do not use any gasoline below the minimum fuel grade as this may impair engine performance. ◀

If you use gasoline with this minimum AKI Rating, the engine may produce knocking sounds when starting at high outside temperatures. This has no effect on the engine life.

 Fuel quality

The use of poor-quality fuels may result in harmful engine deposits or damage. Additionally, problems relating to drivability, starting and stalling, especially under certain environmental conditions such as high ambient temperature and high altitude, may occur.

If drivability problems are encountered, we recommend switching to a high quality gasoline brand and a higher octane grade — AKI number — for a few tank fills. To avoid harmful engine deposits, it is highly recommended to purchase gasoline from BP or Top Tier retailers.

Failure to comply with these recommendations may result in the need for unscheduled maintenance. ◀

BMW recommends BP fuels 

Wheels and tires

Vehicle equipment

All standard, country-specific and optional equipment that is offered in the model series is described in this chapter. Therefore, equipment is also described that is not available in a vehicle, e. g., because of the selected optional equipment or country variant. This also applies for safety-related functions and systems.

Tire inflation pressure

Safety information

The tire characteristics and tire inflation pressure influence the following:

- ▷ The service life of the tires.
- ▷ Road safety.
- ▷ Driving comfort.

Checking the pressure

Only check the tire inflation pressure when the tires are cold. This means after driving no more than 1.25 miles/2 km or when the vehicle has been parked for at least 2 hours. When the tires are warm, the tire inflation pressure is higher.

-  Check the tire inflation pressure regularly
- Regularly check the tire inflation pressure, and correct it as needed: at least twice a month and before a long trip. If you fail to observe this precaution, you may be driving on tires with incorrect tire pressures, a condition that may not only compromise your vehicle's driving stability, but also lead to tire damage and the risk of an accident. ◀

After correcting the tire inflation pressure:

- ▷ Reinitialize the Flat Tire Monitor.
- ▷ Reinitialize the Tire Pressure Monitor.

Pressure specifications

The tire inflation pressure table, refer to page 168, contains all pressure specifications for the specified tire sizes at the ambient temperature. Pressure specifications apply to approved tire sizes and recommended tire brands. This information can be obtained from your service center.

To identify the correct tire inflation pressure, please note the following:

- ▷ Tire sizes of your vehicle.
- ▷ Maximum permitted driving speed.

Tire inflation pressures up to 100 mph/160 km/h

For speeds of up to 100 mph/160 km/h and for optimum driving comfort, note the pressure values in the tire inflation pressure table, refer to page 168, and adjust as necessary.

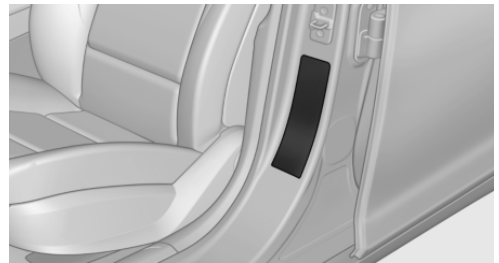

These pressure values can also be found on the tire inflation pressure label on the driver's door pillar.

-  Maximum permissible speed
- Do not exceed 100 mph/160 km/h; otherwise, tire damage and accidents may result. ◀

Tire inflation pressure values up to 100 mph/160 km/h

M6

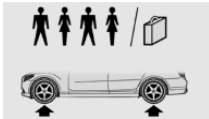
Tire size	Pressure specifications in bar/PSI	
Specifications in bar/PSI with cold tires		
255/40 R 100 V M +S XL	2.5 / 36	2.5 / 36
255/35 R 97 V M +S XL		
Front: 265/40 R 102 Y XL	2.2 / 31	-
Rear: 295/35ZR19 (104Y) XL	-	2.2 / 31
Front: 265/35ZR20 (99Y) XL	2.4 / 34	-
Rear: 295/30ZR20 (101Y) XL	-	2.4 / 34

Tire inflation pressures at max. speeds above 100 mph/160 km/h

 Speeds above 100 mph/160 km/h
 In order to drive at maximum speeds in excess of 100 mph/160 km/h, please observe, and, if necessary, adjust tire pressures for speeds exceeding 100 mph/160 km/h from the relevant table on the following pages. Otherwise tire damage and accidents could occur. ◀

Tire inflation pressure values over 100 mph/160 km/h

M6

With speed limiter:

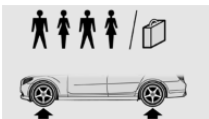
Tire size	Pressure specifications in bar/PSI	
Specifications in bar/PSI with cold tires		
255/40 R 100 V M +S XL	2.8 / 40	3.0 / 43
255/35 R 97 V M +S XL	3.0 / 43	3.2 / 46
Front: 265/40 R 102 Y XL	2.6 / 37	-
Rear: 295/35ZR19 (104Y) XL	-	2.6 / 37
Front: 265/35ZR20 (99Y) XL	2.8 / 40	-
Rear: 295/30ZR20 (101Y) XL	-	2.8 / 40

Without speed limiter:

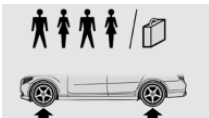
Tire size	Pressure specifications in bar/PSI	
Specifications in bar/PSI with cold tires		
255/40 R 100 V M +S XL	2.8 / 40	3.0 / 43
255/35 R 97 V M +S XL	3.0 / 43	3.2 / 46

Tire size	Pressure specifications in bar/PSI	
Front: 265/40 R 102 Y XL	3.0 / 43	-
Rear: 295/35ZR19 (104Y) XL	-	3.0 / 43
Front: 265/35ZR20 (99Y) XL	3.3 / 47	-
Rear: 295/30ZR20 (101Y) XL	-	3.3 / 47

Tire identification marks

Tire size

245/45 R 18 96 Y

245: nominal width in mm

45: aspect ratio in %

R: radial tire code

18: rim diameter in inches

96: load rating, not for ZR tires

Y: speed rating, before the R on ZR tires

Speed letter

T = up to 118 mph, 190 km/h

H = up to 131 mph, 210 km/h

V = up to 150 mph, 240 km/h

W = up to 167 mph, 270 km/h

Y = up to 186 mph, 300 km/h

Tire Identification Number

DOT code: DOT xxxx xxx 1013

xxxx: manufacturer code for the tire brand

xxx: tire size and tire design

1013: tire age

Tires with DOT codes meet the guidelines of the U.S. Department of Transportation.

Tire age

DOT ... 1013: the tire was manufactured in the 10th week 2013.

Recommendation

Regardless of wear, replace tires at least every 6 years.

Uniform Tire Quality Grading

Quality grades can be found where applicable on the tire sidewall between tread shoulder and maximum section width.

For example: Treadwear 200; Traction AA; Temperature A

DOT Quality Grades

Treadwear

Traction AA A B C

Temperature A B C

All passenger car tires must conform to Federal Safety Requirements in addition to these grades.

Treadwear

The treadwear grade is a comparative rating based on the wear rate of the tire when tested under controlled conditions on a specified government test course. For example, a tire graded 150 would wear one and one-half, 1 g, times as well on the government course as a tire graded 100. The relative performance of tires depends upon the actual conditions of their use, however, and may depart significantly from the norm due to variations in driving habits, service practices and differences in road characteristics and climate.

Traction

The traction grades, from highest to lowest, are AA, A, B, and C.

Those grades represent the tire's ability to stop on wet pavement as measured under controlled conditions on specified government

test surfaces of asphalt and concrete. A tire marked C may have poor traction performance. The traction grade assigned to this tire is based on straight-ahead braking traction tests, and does not include acceleration, cornering, hydroplaning, or peak traction characteristics.

Temperature

The temperature grades are A, the highest, B, and C, representing the tire's resistance to the generation of heat and its ability to dissipate heat when tested under controlled conditions on a specified indoor laboratory test wheel. Sustained high temperature can cause the material of the tire to degenerate and reduce tire life, and excessive temperature can lead to sudden tire failure. The grade C corresponds to a level of performance which all passenger car tires must meet under the Federal Motor Vehicle Safety Standard No. 109. Grades Band A represent higher levels of performance on the laboratory test wheel than the minimum required by law.

 Temperature grade for this tire

The temperature grade for this tire is established for a tire that is properly inflated and not overloaded. Excessive speed, underinflation, or excessive loading, either separately or in combination, can cause heat buildup and possible tire failure.

If necessary, have the vehicle towed. ◀

M+S

Winter and all-season tires with better cold weather performance than summer tires.

Tire tread

Summer tires

Do not drive with a tire tread depth of less than 0.12 in/3 mm.

There is an increased danger of hydroplaning if the tread depth is less than 0.12 in/3 mm.

Winter tires

Do not drive with a tire tread depth of less than 0.16 in/4 mm.

Below a tread depth of 0.16 in/4 mm, tires are less suitable for winter operation.

Minimum tread depth

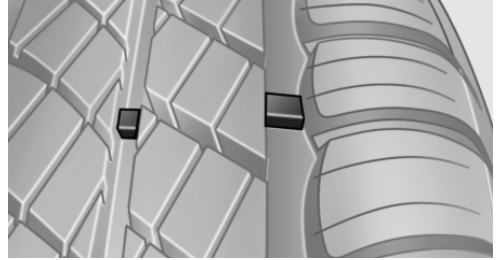

Wear indicators are distributed around the tire's circumference and have the legally required minimum height of 0.063 in/1.6 mm.

They are marked on the side of the tire with TWI, Tread Wear Indicator.

Tire damage

General information

Inspect your tires often for damage, foreign objects lodged in the tread, and tread wear.

Notes

Driving over rough or damaged road surfaces, as well as debris, curbs and other obstacles can cause serious damage to wheels, tires and suspension parts. This is more likely to occur with low-profile tires, which provide less cushioning between the wheel and the road. Be careful to avoid road hazards and reduce your speed, especially if your vehicle is equipped with low-profile tires.

Indications of tire damage or other vehicle defects:

- ▷ Unusual vibrations during driving.

- ▷ Unusual handling such as a strong tendency to pull to the left or right.

Damage can, e. g., be caused by driving over curbs, road damage, or similar things.



In case of tire damage

If there are indications of tire damage, reduce your speed immediately and have the wheels and tires checked right away; otherwise, there is the increased risk of an accident.

Drive carefully to the nearest service center. If necessary, have the vehicle towed.

Otherwise, tire damage can be life-threatening for vehicle occupants and other traffic participants. ◀



Repair of tire damage

For safety reasons, the manufacturer of your vehicle recommends that you do not have damaged tires repaired; they should be replaced. Otherwise, damage can occur as a result. ◀

Changing wheels and tires

Mounting



Information on mounting tires

Have mounting and balancing performed only by a service center.

If this work is not carried out properly, there is the danger of subsequent damage and related safety hazards. ◀

Wheel and tire combination

Information on the correct wheel-tire combination and rim versions for your vehicle can be obtained from your service center.

Incorrect wheel and tire combinations impair the function of a variety of systems such as ABS or DSC.

To maintain good handling and vehicle response, use only tires with a single tread configuration from a single manufacturer.

Following tire damage, have the original wheel and tire combination remounted on the vehicle as soon as possible.



Approved wheels and tires

The manufacturer of your vehicle recommends that you use only wheels and tires that have been approved for your particular vehicle model.

For example, despite having the same official size ratings, variations can lead to body contact and with it, the risk of severe accidents.

The manufacturer of your vehicle cannot evaluate non-approved wheels and tires to determine if they are suited for use, and therefore cannot ensure the operating safety of the vehicle if they are mounted. ◀

Recommended tire brands



For each tire size, the manufacturer of your vehicle recommends certain tire brands. These can be identified by a star on the tire sidewall.

With proper use, these tires meet the highest standards for safety and handling.

New tires

Due to technical factors associated with their manufacture, tires do not achieve their full traction potential until after an initial breaking-in period.

Drive conservatively for the first 200 miles/300 km.

Retreaded tires

The manufacturer of your vehicle does not recommend the use of retreaded tires.



Retreaded tires

Possibly substantial variations in the design and age of the tire casing structures can limit service life and have a negative impact on road safety. ◀

Winter tires

The manufacturer of your vehicle recommends winter tires for winter roads or at temperatures below +45 °F/+7 °C.

Although so-called all-season M+S tires do provide better winter traction than summer tires, they do not provide the same level of performance as winter tires.

Maximum speed of winter tires

If the maximum speed of the vehicle is higher than the permissible speed for the winter tires, then display a corresponding sign in the field of vision. You can obtain this sign from the tire specialist or from your service center.



Maximum speed for winter tires

Do not exceed the maximum speed for the winter tires; otherwise, tire damage and accidents can occur. ◀

Rotating wheels between axles

The manufacturer of your vehicle advises against switching wheels between the front and rear axles.

This can impair the handling characteristics.

Rotating the tires is not permissible when using different types of tires.

Storage

Store wheels and tires in a cool, dry place with as little exposure to light as possible.

Always protect tires against all contact with oil, grease and fuels.

Do not exceed the maximum tire inflation pressure indicated on the side wall of the tire.

Repairing a flat tire



Safety measures in case of a breakdown

Park the vehicle as far away as possible from passing traffic and on solid ground.

Switch on the hazard warning system.

Turn the steering wheel until the front wheels are in the straight-ahead position and engage the steering wheel lock.

Secure vehicle against rolling away by setting the parking brake and switching off the ignition.

Have all vehicle occupants get out of the vehicle and ensure that they remain outside the immediate area in a safe place, such as behind a guardrail.

If necessary, set up a warning triangle at an appropriate distance.

Comply with all safety guidelines and regulations. ◀

Mobility System

Notes

- ▶ Follow the instructions on using the Mobility System found on the compressor and sealant bottle.
- ▶ Use of the Mobility System may be ineffective if the tire puncture measures approx. 1/8 in/4 mm or more.
- ▶ Contact the nearest service center if the tire cannot be made drivable.

- ▷ If possible, do not remove foreign bodies that have penetrated the tire.
- ▷ Pull the speed limit sticker off the sealant bottle and apply it to the steering wheel.

Storage

The Mobility System is located under the cargo floor panel in the cargo area.

Sealant bottle



- ▷ Sealant bottle, arrow 1.
- ▷ Filling hose, arrow 2.

Note the use-by date on the sealant bottle.

Compressor

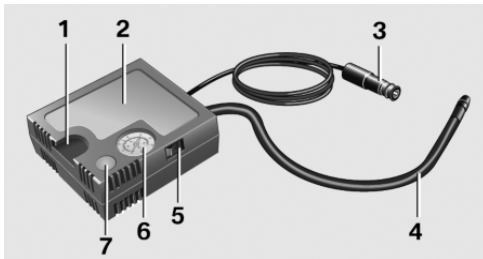

- 1 Holder for bottle
- 2 Compressor
- 3 Connector/cable for socket
- 4 Connection hose
- 5 On/off switch
- 6 Inflation pressure dial
- 7 Reduce inflation pressure

Filling the tire with sealant

1. Shake the sealant bottle.



2. Pull the connection hose fully out of the compressor housing. Do not kink the hose.

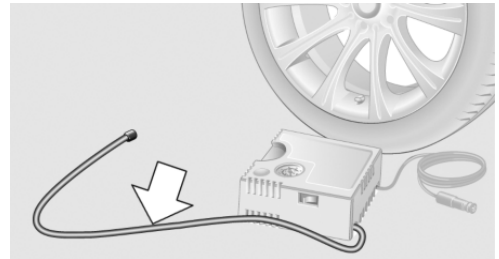

3. Screw the connection hose onto the connector of the sealing bottle.

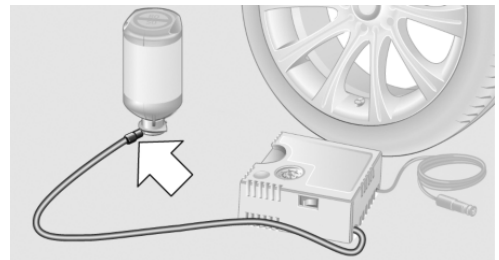

4. Insert the sealant bottle on the compressor housing in an upright position.

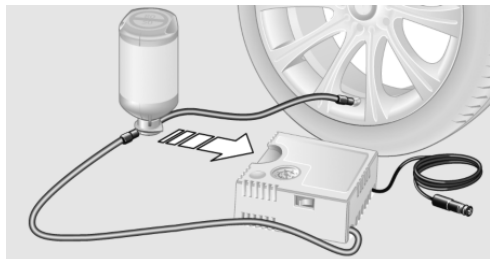

5. Screw the filling hose of the sealant bottle onto the valve of the defective wheel.

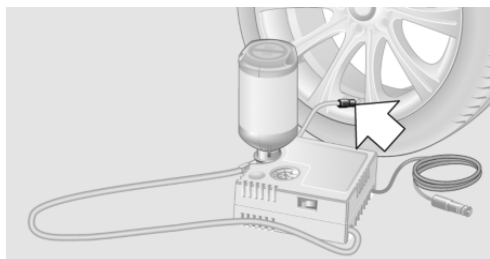

6. With the compressor switched off, insert the plug into the power socket inside the vehicle.

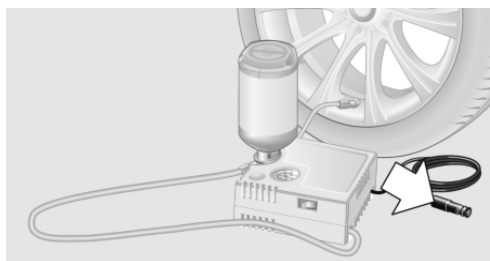

7. With the ignition turned on or the engine running, switch on the compressor.

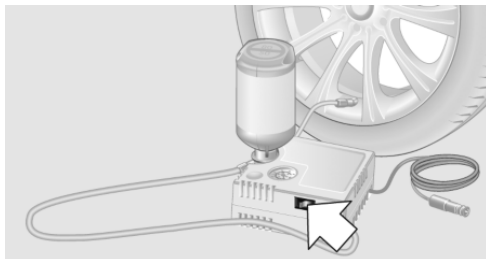

Let the compressor run for approx. 3 to 8 minutes to fill the tire with sealant and achieve a tire inflation pressure of approx. 2.5 bar.

While the tire is being filled with sealant, the inflation pressure may sporadically reach approx. 5 bar. Do not switch off the compressor in this phase.



Enclosed areas

Do not let the engine run in enclosed areas; otherwise, breathing of exhaust fumes may lead to loss of consciousness and death. The exhaust gases contain carbon monoxide, an odorless and colorless but highly toxic gas. ◀



Switch off the compressor after 10 minutes

Do not allow the compressor to run longer than 10 minutes; otherwise, the device will overheat and may be damaged. ◀

If a tire pressure of 2 bar is not reached:

1. Switch off the compressor.
2. Unscrew the filling hose from the wheel.
3. Drive forward and back to distribute the sealant in the tire.
4. Inflate the tire again using the compressor.

If an inflation pressure of 2 bar cannot be reached, contact your service center.

Stowing the Mobility System

1. Unscrew the filling hose of the sealant bottle from the wheel.
2. Unscrew the compressor connection hose from the sealant bottle.
3. Connect the sealant bottle filling hose that was previously connected to the valve to the vacant connector on the sealant bottle.
This prevents left-over sealant from escaping from the bottle.
4. Wrap the empty sealant bottle in suitable material to avoid dirtying the cargo area.
5. Stow the Mobility System back in the vehicle.

Distributing the sealant

Immediately drive approx. to ensure that the sealant is evenly distributed in the tire.

Do not exceed a speed of .

Do not drop below if possible.

Correcting the tire inflation pressure

1. Stop at a suitable location.
2. Screw the connection hose of the compressor directly onto the tire valve.
3. Insert the connector into the power socket in the vehicle interior.
4. Correct the tire inflation pressure to 2.5 bar.
 - ▷ Increase pressure: with the ignition turned on or the engine running, switch on the compressor.
 - ▷ To reduce the pressure: press the button on the compressor.

Continuing the trip

Do not exceed the maximum permissible speed of 50 mph/80 km/h.

Reinitialize the Flat Tire Monitor, refer to page 104.

Reinitialize the Tire Pressure Monitor, refer to page 102.

Replace the defective tire and the sealant bottle of the Mobility System as soon as possible.

Snow chains

Fine-link snow chains

Only certain types of fine-link snow chains have been tested by the manufacturer of your vehicle, classified as road-safe and recommended.

Consult your service center for more information.

Use

Use only in pairs on the rear wheels, equipped with the tires of the following size:

255/40 R 19

Follow the chain manufacturer's instructions.

Make sure that the snow chains are always sufficiently tight. Retighten as needed according to the chain manufacturer's instructions.

Do not initialize the Flat Tire Monitor after mounting snow chains, as doing so may result in incorrect readings.

Do not initialize the Tire Pressure Monitor after mounting snow chains, as doing so may result in incorrect readings.

When driving with snow chains, if necessary briefly activate M Dynamic Mode.

Maximum speed with snow chains

Do not exceed a speed of 30 mph/50 km/h when using snow chains.

Engine compartment

Vehicle equipment

All standard, country-specific and optional equipment that is offered in the model series is described in this chapter. Therefore, equip-

ment is also described that is not available in a vehicle, e. g., because of the selected optional equipment or country variant. This also applies for safety-related functions and systems.

Important features in the engine compartment

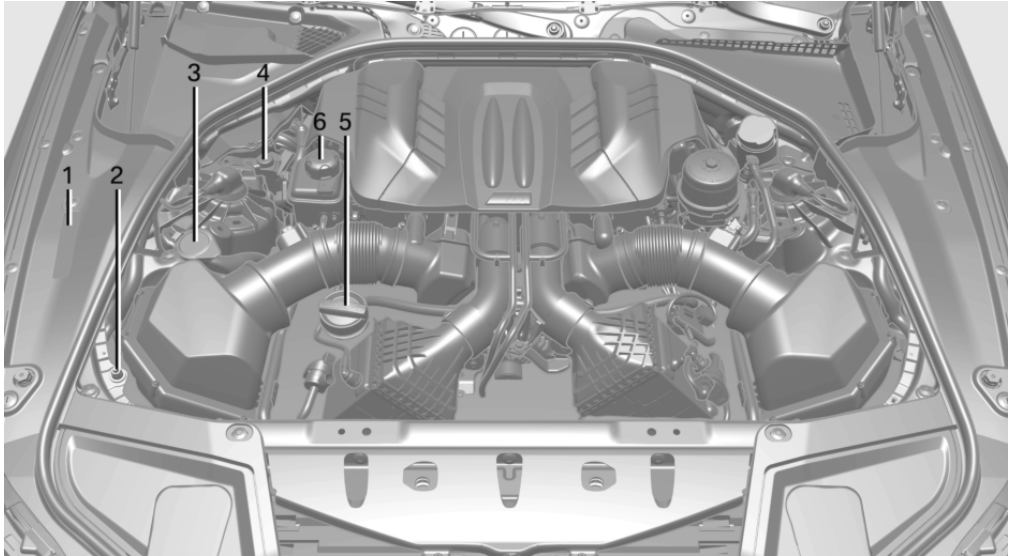

- | | |
|---|---|
| <ul style="list-style-type: none"> 1 Vehicle identification number 2 Jump-starting, negative terminal 3 Washer fluid reservoir | <ul style="list-style-type: none"> 4 Jump-starting, positive terminal 5 Oil filler neck. 6 Coolant reservoir |
|---|---|

Hood

Opening the hood



Working in the engine compartment

Never attempt to perform any service or repair operations on your vehicle without the necessary professional technical training.

If you are unfamiliar with the statutory guidelines, have any work on the vehicle performed only by a service center.

If this work is not carried out properly, there is the danger of subsequent damage and related safety hazards. ◀

 Never reach into the engine compartment

Never reach into the intermediate spaces or gaps in the engine compartment. Otherwise, there is risk of injury, e.g., from rotating or hot parts. ◀

1. Pull the lever.

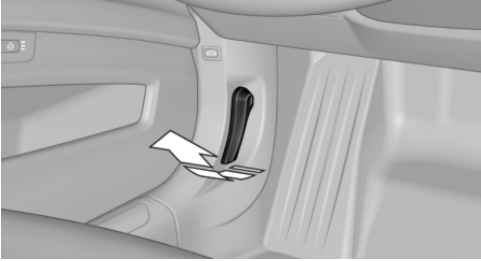

2. Press the release handle and open the hood.

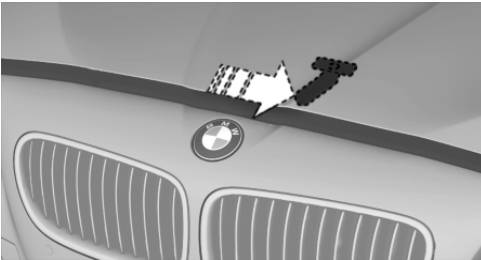

3. Be careful of protruding parts on the hood.



 Danger of injury when the hood is open
There is a danger of injury from protruding parts when the hood is open. ◀

Closing the hood

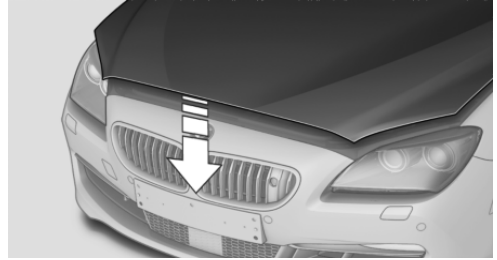

Let the hood drop from a height of approx. 16 in/40 cm and push down on it to lock it fully.

The hood must audibly engage on both sides. ◀

 Hood open when driving

If you see any signs that the hood is not completely closed while driving, pull over immediately and close it securely. ◀

 Danger of pinching

Make sure that the closing path of the hood is clear; otherwise, injuries may result. ◀

Engine oil

Vehicle equipment

All standard, country-specific and optional equipment that is offered in the model series is described in this chapter. Therefore, equipment is also described that is not available in a vehicle, e. g., because of the selected optional equipment or country variant. This also applies for safety-related functions and systems.

General information

The engine oil consumption is dependent on the driving style and driving conditions. When a sporty driving style is used, the engine oil consumption, for example, is clearly higher.

Therefore, regularly check the engine oil level after refueling.

When a dynamic driving style is used, such as when cornering quickly, the system is unable to measure the engine oil level. With this driving style, measure the engine oil level using a detailed measurement, refer to page 178.

Checking the oil level electronically

Status display

The concept

The oil level is monitored electronically during driving and shown on the Control Display.

If the oil level reaches the minimum level, a check control message is displayed.

Requirements

Depending on the previous displays, the status display is displayed when the engine is running or after the vehicle has been driven for at least 30 minutes.

Displaying the oil level

1. "Vehicle Info"
2. "Vehicle status"
3.  "Engine oil level"

Oil level display messages

Different messages appear on the display depending on the oil level. Pay attention to these messages.

If oil level is too low, immediately add 1 US quart/liter of oil.

Take care not to add too much engine oil.



Too much engine oil

Have the vehicle checked immediately; otherwise, surplus oil can lead to engine damage. ◀

Detailed measurement

The concept

In the detailed measurement the oil level is checked and displayed via a scale.

During the measurement, the idle speed is increased somewhat.

General information

A detailed measurement is only possible with certain engines.

Requirements

- ▷ Selector lever in transmission position N and accelerator not depressed.
- ▷ Vehicle is on a level road and the engine is running at operating temperature.

Performing a detailed measurement

In order to perform a detailed measurement of the engine oil level:

1. "Vehicle Info"
2. "Vehicle status"
3.  "Measure engine oil level"
4. "Start measurement"

The oil level is checked and displayed via a scale.

Duration: approx. 1 minute.

Adding engine oil

Filler neck

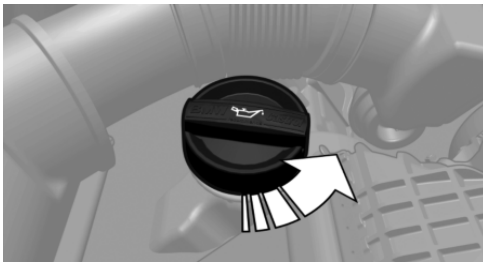

When the indicator lights up in the instrument cluster, add 1 US quart/liter of engine oil within the next 125 miles/200 km.

-  **Protect children**
Keep oil, grease, etc., out of reach of children and heed the warnings on the containers to prevent health risks. ◀

Oil types for refilling

Hints

-  **No oil additives**
Oil additives may lead to engine damage. ◀



Viscosity grades for engine oils

When selecting an engine oil, ensure that the engine oil belongs to the viscosity grade SAE 0W-30 or SAE 0W-40 or malfunctions or engine damage may occur.

Alternatively, also engine oils with viscosity grades SAE 5W-30 or SAE 5W-40 may be used. ◀

The engine oil quality is critical for the life of the engine.

Some types of oils in some cases are not available in all countries.

Approved oil types

Specification

ACEA A3/B4.

API SK/CF or superior grade specification.

Additional information about the approved types of oils can be requested from the service center.

Alternative oil types

If the approved engine oils are not available, up to 1 US quart/liter of an oil with the following specification can be added:

Specification

ACEA A3/B3.

API SK or superior grade specification.

Low ambient temperatures

From the factory, types of oil are used for the vehicle that can be employed in practically all ambient temperatures.

If the vehicle is used for a longer period at temperatures below $-4\text{ }^{\circ}\text{F}/-20\text{ }^{\circ}\text{C}$, ask the service center about suitable oil types.

Engine oil change

The manufacturer of your vehicle recommends having the engine oil changed by your service center.

BMW recommends 

Coolant

Vehicle equipment

All standard, country-specific and optional equipment that is offered in the model series is described in this chapter. Therefore, equipment is also described that is not available in a vehicle, e. g., because of the selected optional equipment or country variant. This also applies for safety-related functions and systems.

General information

 **Danger of burns from hot engine**
Do not open the cooling system while the engine is hot; otherwise, escaping coolant may cause burns. ◀

 **Suitable additives**
Only use suitable additives; otherwise, engine damage may occur. The additives are harmful to your health. ◀

Coolant consists of water and additives.

Not all commercially available additives are suitable for your vehicle. Ask your service center for suitable additives.

Coolant level

Checking

1. Let the engine cool.
2. Turn the cap of the coolant reservoir slightly counterclockwise to allow any ex-

cess pressure to dissipate, and then open it.

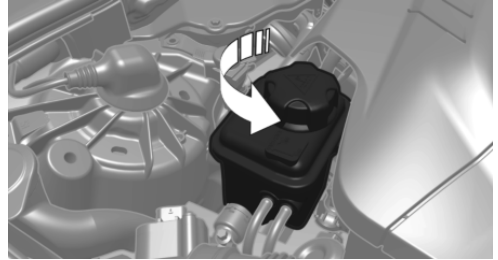

3. The coolant level is correct if it lies between the minimum and maximum marks in the filler neck.



4. If the coolant is low, slowly add coolant up to the specified level; do not overfill.
5. Turn the cap.
6. Have the cause of the coolant loss eliminated as soon as possible.

Disposal



Comply with the relevant environmental protection regulations when disposing of coolant and coolant additives.

Maintenance

Vehicle equipment

All standard, country-specific and optional equipment that is offered in the model series is described in this chapter. Therefore, equipment is also described that is not available in a vehicle, e. g., because of the selected optional equipment or country variant. This also applies for safety-related functions and systems.

BMW Maintenance System

The maintenance system directs you to required maintenance measures and thereby supports you in maintaining road safety and the operational reliability of the vehicle.

Condition Based Service CBS

Sensors and special algorithms take into account the driving conditions of your vehicle. Based on this, Condition Based Service determines the maintenance requirements.

The system makes it possible to adapt the amount of maintenance you need to your user profile.

Details on the service requirements, refer to page 85, can be displayed on the Control Display.

Service data in the remote control

Information on the required maintenance is continuously stored in the remote control. Your service center will read out this data and suggest the right array of service procedures for your vehicle.

Therefore, hand your service specialist the remote control with which the vehicle was driven most recently.

Storage periods

Storage periods during which the vehicle battery was disconnected are not taken into account.

If this occurs, have a service center update the time-dependent maintenance procedures, such as checking brake fluid and, if necessary, changing the engine oil and the microfilter/activated-charcoal filter.

Service booklet

Perform maintenance work at the service center, and record the work in the service booklet. The entries are proof of regular maintenance.

Service and Warranty Information Booklet for US models and Warranty and Service Guide Booklet for Canadian models

Please consult your Service and Warranty Information Booklet for US models and Warranty and Service Guide Booklet for Canadian models for additional information on service requirements.

Maintenance and repair should be performed by your service center. Make sure to have regular maintenance procedures recorded in the vehicle's Service and Warranty Information Booklet for US models, and in the Warranty and Service Guide Booklet for Canadian models. These entries are proof of regular maintenance.

Socket for OBD Onboard Diagnosis

Position

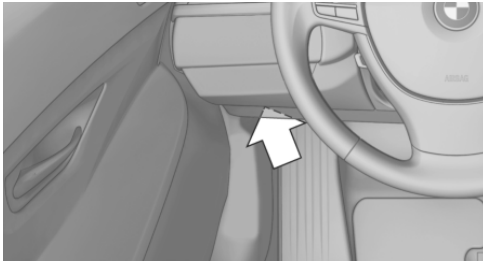

There is an OBD socket on the driver's side for checking the primary components in the vehicle emissions.

Emissions



- ▷ The warning lamp lights up:
Emissions are deteriorating. Have the vehicle checked as soon as possible.



Canadian model: warning light indicates the engine symbol.

- ▷ The warning lamp flashes under certain circumstances:

This indicates that there is excessive misfiring in the engine.

Reduce the vehicle speed and have the system checked immediately; otherwise, serious engine misfiring within a brief period can seriously damage emission control components, in particular the catalytic converter.

Fuel cap



The indicator lamp lights up.

If the fuel cap is not properly tightened, the OBD system may conclude that fuel vapor is escaping. If the cap is then tightened, the display should go out in a short time.

Replacing components

Vehicle equipment

All standard, country-specific and optional equipment that is offered in the model series is described in this chapter. Therefore, equipment is also described that is not available in a vehicle, e. g., because of the selected optional equipment or country variant. This also applies for safety-related functions and systems.

Onboard vehicle tool kit



The onboard vehicle tool kit is stored under the cargo floor cover in the cargo area.

Wiper blade replacement

General information

 Do not fold down the wipers without wiper blades

Do not fold down the wipers if wiper blades have not been installed; this may damage the windshield. ◀

Replacing the wiper blades

1. To change the wiper blades, fold up, refer to page 77, the wiper arms.
2. Fold up the wipers.

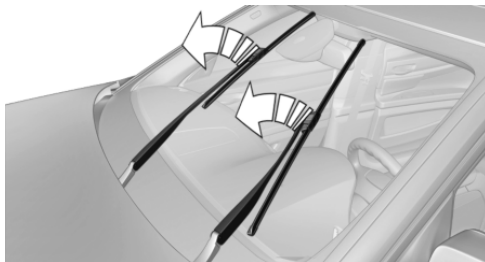

3. Position the wiper blade in a horizontal position.
4. Remove the wiper blade toward one side.

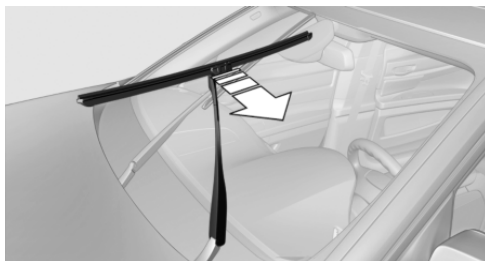

5. Insert the new wiper blade in reverse order of removal until it locks in place.
6. Fold down the wipers.

Lamp and bulb replacement

Hints

Lamps and bulbs

Lamps and bulbs make an essential contribution to vehicle safety.

The manufacturer of the vehicle recommends that you entrust corresponding procedures to

the service center if you are unfamiliar with them or they are not described here.

You can obtain a selection of replacement bulbs at the service center.



Danger of burns

Only change bulbs when they are cool; otherwise, there is the danger of getting burned. ◀



Working on the lighting system

When working on the lighting system, you should always switch off the lights affected to prevent short circuits.

To avoid possible injury or equipment damage when replacing bulbs, observe any instructions provided by the bulb manufacturer. ◀



Do not perform work/bulb replacement on xenon headlamps

Have any work on the xenon lighting system, including bulb replacement, performed only by a service center. Due to the high voltage present in the system, there is the danger of fatal injuries if work is carried out improperly. ◀



Do not touch the bulbs

Do not touch the glass of new bulbs with your bare hands, as even minute amounts of contamination will burn into the bulb's surface and reduce its service life.

Use a clean tissue, cloth or something similar, or hold the bulb by its base. ◀

Light-emitting diodes (LEDs)

Light-emitting diodes installed behind a cover serve as the light source for controls, display elements and other equipment.

These light-emitting diodes, which are related to conventional lasers, are officially designated as Class 1 light-emitting diodes.



Do not remove the covers

Do not remove the covers, and never stare into the unfiltered light for several hours; otherwise, irritation of the retina could result. ◀

Headlamp glass

Condensation can form on the inside of the external lamps in cool or humid weather. When driving with the light switched on, the condensation evaporates after a short time. The headlamp glasses do not need to be changed.

If the headlamps do not dim despite driving with the light switched on, increasing humidity forms, e. g. water droplets in the light, have the service center check this.

Headlamp setting

The headlamp adjustments can be affected by changing lamps and bulbs. Therefore after a change, have the headlamp setting checked and corrected by Service.

Xenon headlamps

Hints

Because of the long life of these bulbs, the likelihood of failure is very low. Switching the lamps on and off frequently shortens their life.



Do not perform work/bulb replacement on xenon headlamps

Have any work on the xenon lighting system, including bulb replacement, performed only by a service center. Due to the high voltage present in the system, there is the danger of fatal injuries if work is carried out improperly. ◀

For checking and adjusting headlamp aim, please contact your BMW center.

Light-emitting diodes (LEDs)

Follow the general instructions on Lamps and bulbs, refer to page 184.

With Xenon-headlamps, the following lamps are designed with LED technology:

- ▷ Parking lamps and roadside parking lamps.
- ▷ Turn signals, incl. side indicators
- ▷ Daytime running lights

Contact your service center in the event of a malfunction.

Turning lamp on the Xenon headlamp

Follow the general instructions on lamps and bulbs, refer to page 184.

The illustration shows the left side of the engine compartment.

55-watt bulb, H3

1. Turn the cap and remove it.

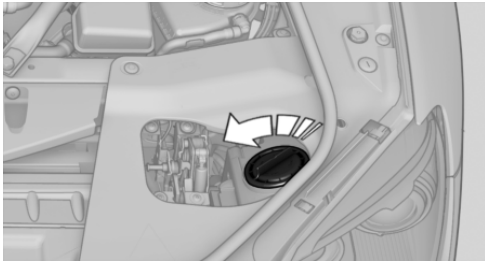

2. Detach the wire bracket.

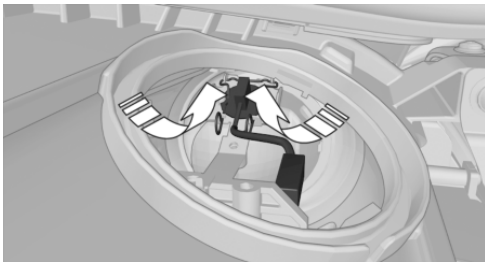

3. Disconnect the cable at the plug-in connection and remove the bulb.
4. Insert the new bulb. Ensure that the bulb has the correct orientation. Because of its shape, the bulb can only be inserted in one direction.
5. Secure the bulb with the wire bracket.
6. Connect the bulb.
7. Mount the cap.

LED headlamps

Light-emitting diodes (LEDs)

Follow the general instructions on Lamps and bulbs, refer to page 184.

With LED headlamps, all front lamps and side indicators are designed with LED technology.

Contact your service center in the event of a malfunction.

Tail lamps, bulb replacement

At a glance

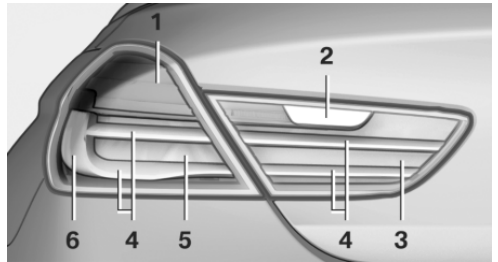

- 1 Turn signal/brake lamp
- 2 Reversing lamp
- 3 Inside brake lamp
- 4 Tail lamp
- 5 Outside brake lamp
- 6 Rear reflector

Turn signal, outer brake, tail, and license plate lamps

Follow the general instructions on lamps and bulbs, refer to page 184.

These lights feature LED technology.

Contact your service center in the event of a malfunction.

Lamps in the trunk lid

Access to the lamps

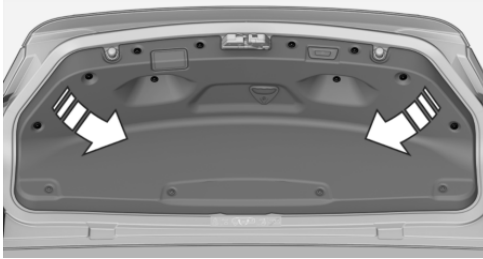

If necessary, remove the fasteners using the screwdriver from the onboard vehicle tool kit and fold away the cover.

Inside brake lamp

Follow the general instructions on Lamps and bulbs, refer to page 184.

24-watt bulb, HP24W

1. Squeeze the bulb holder and pull it out.

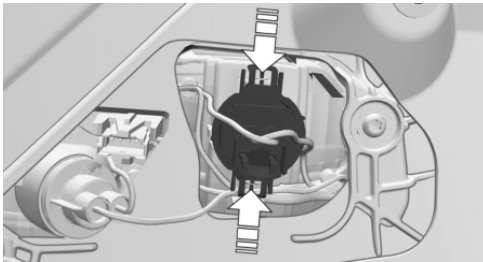

2. Pull off the connector.
3. Replace the bulb.
4. Mount the bulb holder and the cover of the trunk lid in reverse order.

Reversing lamp

Follow the general instructions on Lamps and bulbs, refer to page 184.

16-watt bulb, W16W

1. Unscrew the bulb holder counterclockwise.

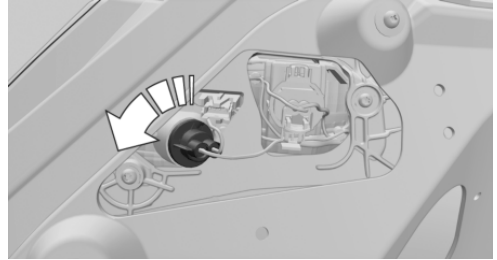

2. Pull out the bulb and replace it.
3. Mount the bulb holder and the cover of the trunk lid in reverse order.

Changing wheels

Hints

The vehicle equipment does not include a spare tire.

When using run-flat tires or tire sealants, a tire does not need to be changed immediately in the event of pressure loss due to a flat tire.

The tools for changing wheels are available as accessories from your service center.

Jacking points for the vehicle jack

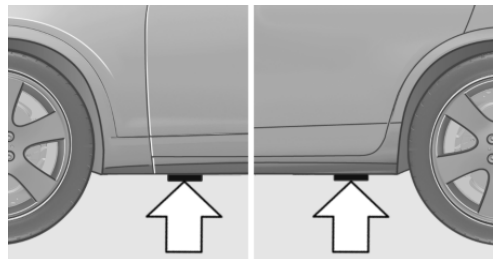

The jacking points for the vehicle jack are located at the positions shown.

Vehicle battery

Maintenance

The battery is maintenance-free, i.e., the electrolyte will last for the life of the battery.

Your service center will be glad to advise you on questions regarding the battery.

Battery replacement



Use approved vehicle batteries only

Only use vehicle batteries that have been approved for your vehicle by the manufacturer; otherwise, the vehicle could be damaged and systems or functions may not be fully available. ◀

After a battery replacement, have the battery registered on the vehicle by your service center to ensure that all comfort functions are fully available and that any Check Control messages of these comfort functions are no longer displayed.

Charging the battery

Note



Do not plug chargers into the socket

Do not connect battery chargers to the factory-installed sockets in the vehicle as this may damage the battery. ◀

General information

Make sure that the battery is always sufficiently charged to guarantee that the battery remains usable for its full service life.

The battery may need to be charged in the following cases:

- ▶ When making frequent short-distance drives.
- ▶ If the vehicle is not used for prolonged periods, longer than a month.

Starting aid terminals

In the vehicle, only charge the battery via the starting aid terminals, refer to page 192, in the engine compartment with the engine off.

Power failure

After a temporary power loss, some equipment needs to be reinitialized.

Individual settings need to be reprogrammed:

- ▶ Seat, mirror, and steering wheel memory: store the positions again.
- ▶ Time: update.
- ▶ Date: update.
- ▶ Radio station: saving new, see user's manual for Navigation, Entertainment and Communication.
- ▶ Navigation system: wait for the operability of the navigation.

Disposing of old batteries



Have old batteries disposed of by your service center or bring them to a recycling center.

Maintain the battery in an upright position for transport and storage. Secure the battery so that it does not tip over during transport.

Fuses

Notes



Replacing fuses

Never attempt to repair a blown fuse and do not replace a defective fuse with a substitute of another color or amperage rating; this could lead to a circuit overload, ultimately resulting in a fire in the vehicle. ◀

Plastic tweezers and information on the fuse types and locations are stored in the fuse box in the cargo area.

In the glove compartment

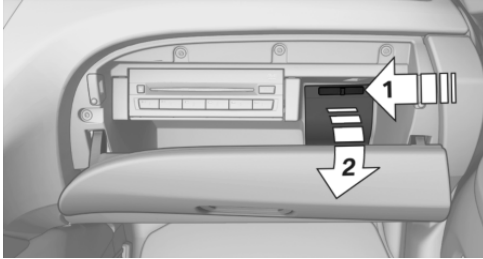

Push the handle to the side, arrow 1, and open the lid, arrow 2.

In the cargo area

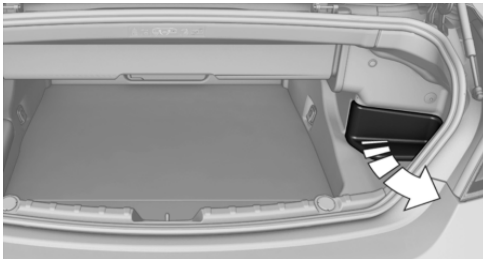

Open the cover on the right side trim.

Information on the fuse types and locations is found on a separate sheet.

Breakdown assistance

Vehicle equipment

All standard, country-specific and optional equipment that is offered in the model series is described in this chapter. Therefore, equipment is also described that is not available in a vehicle, e. g., because of the selected optional equipment or country variant. This also applies for safety-related functions and systems.

Hazard warning flashers

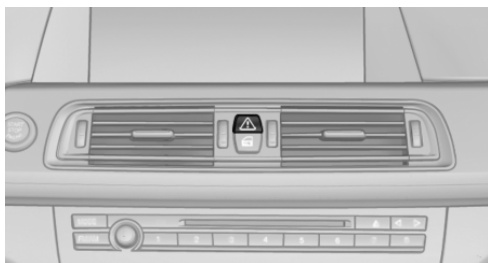

The button is located in the center console.

Intelligent Emergency Request

Requirements

- ▷ The radio ready state is switched on.
- ▷ The Assist system is functional.
- ▷ The SIM card integrated in the vehicle has been activated.
- ▷ A ConnectedDrive contract is available.

General information

Only press the SOS button in an emergency.

Hints



Emergency Request not guaranteed
For technical reasons, the Emergency Request cannot be guaranteed under unfavorable conditions. ◀

Initiating an Emergency Request



1. Press the cover briefly to open it.
 2. Press the SOS button until the LED in the button lights up.
- ▷ The LED lights up: an Emergency Request was initiated.

If the situation allows, wait in your vehicle until the voice connection has been established.

- ▷ The LED flashes when a connection to the BMW Response Center has been established.

When the emergency request is received at the BMW Response Center, the BMW Response Center contacts you and takes further steps to help you.

Even if you are unable to respond, the BMW Response Center can take further steps to help you under certain circumstances.

For this purpose, data that are used to determine the necessary rescue measures, such as the current position of the vehicle

if it can be established, are transmitted to the BMW Response Center.

- ▶ If the LED is flashing, but the BMW Response Center can no longer be heard via the speaker, you can nevertheless still be heard for the BMW Response Center.

Initiating an Emergency Request automatically

Under certain conditions, an Emergency Request is automatically initiated immediately after a severe accident. Automatic Collision Notification is not affected by pressing the SOS button.

Warning triangle

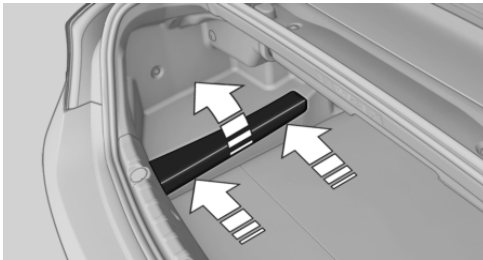

The warning triangle is located under a cover on the left side of the cargo area.

Press against the lower edge of the cover and remove the cover.

First aid kit

Note

Some of the articles have a limited service life. Check the expiration dates of the contents regularly and replace any expired items promptly.

Storage

The first aid kit is located in the insert in the rear seat backrest.

1. Pull the release in the direction of the arrow, and remove the insert from the front. If necessary, when pulling the release, press against the insert.

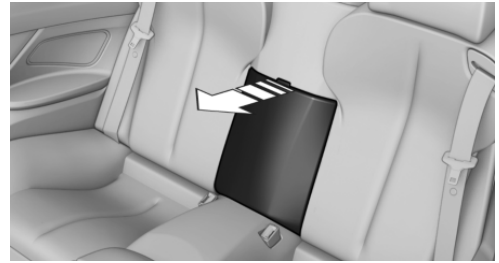

2. Remove the first aid kit.



When replacing the insert, place both pins into the rail at the bottom and press the insert back in place until a 'click' is heard. Ensure that the rear seat backrest upholstery is not damaged.

Roadside Assistance

Service availability

Roadside Assistance can be reached around the clock in many countries. You can obtain assistance there in the event of a vehicle breakdown.

Roadside Assistance

The Roadside Assistance phone number can be viewed on the iDrive or a connection to

Roadside Assistance can be established directly.

Jump-starting

Notes

If the battery is discharged, an engine can be started using the battery of another vehicle and two jumper cables. Only use jumper cables with fully insulated clamp handles.

To prevent personal injury or damage to both vehicles, adhere strictly to the following procedure.

 Do not touch live parts

To avoid the risk of potentially fatal injury, always avoid all contact with electrical components while the engine is running. ◀

Preparation

1. Check whether the battery of the other vehicle has a voltage of 12 volts. This information can be found on the battery.
2. Switch off the engine of the assisting vehicle.
3. Switch off any electronic systems/power consumers in both vehicles.

 Bodywork contact between vehicles
Make sure that there is no contact between the bodywork of the two vehicles; otherwise, there is the danger of short circuits. ◀

Starting aid terminals

 Connecting order
Connect the jumper cables in the correct order; otherwise, there is the danger of injury from sparking. ◀

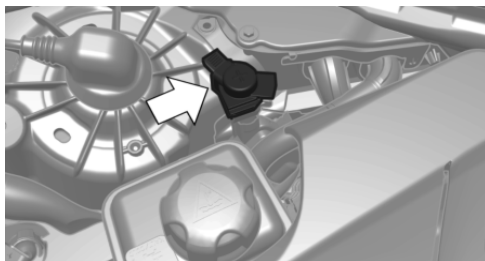

The so-called starting aid terminal in the engine compartment acts as the battery's positive terminal.

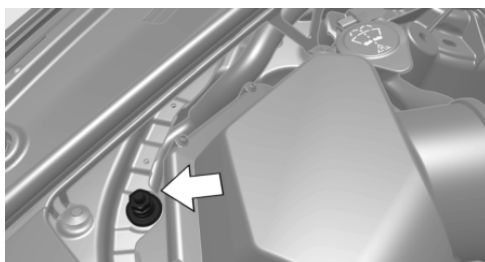

The body ground or a special nut acts as the battery negative terminal.

Connecting the cables

1. Pull off the cap of the BMW starting aid terminal.
2. Attach one terminal clamp of the positive jumper cable to the positive terminal of the battery, or to the corresponding starting aid terminal of the vehicle providing assistance.
3. Attach the terminal clamp on the other end of the cable to the positive terminal of the battery, or to the corresponding starting aid terminal of the vehicle to be started.
4. Attach one terminal clamp of the negative jumper cable to the negative terminal of the battery, or to the corresponding engine or body ground of assisting vehicle.
5. Attach the second terminal clamp to the negative terminal of the battery, or to the

corresponding engine or body ground of the vehicle to be started.

Starting the engine

Never use spray fluids to start the engine.

1. Start the engine of the assisting vehicle and let it run for several minutes at an increased idle speed.
2. Start the engine of the vehicle being started in the usual way.
If the first starting attempt is not successful, wait a few minutes before making another attempt in order to allow the discharged battery to recharge.
3. Let both engines run for several minutes.
4. Disconnect the jumper cables in the reverse order.

Check the battery and recharge if necessary.

Tow-starting and towing

Manual transmission

Observe before towing your vehicle

Gearshift lever in neutral position.

Towing

 When the parking brake is blocked
The parking brake cannot be released manually.

Do not tow the vehicle with the parking brake blocked, or the vehicle can be damaged.

Contact your service center. ◀

 Follow the towing instructions
Follow all towing instructions; otherwise, vehicle damage or accidents may occur. ◀

- ▶ Make sure that the ignition is switched on; otherwise, the low beams, tail lamps, turn signals, and windshield wipers may be unavailable.

- ▶ Do not tow the vehicle with the rear axle tilted, as the front wheels could turn.
- ▶ When the engine is stopped, there is no power assist. Consequently, more force needs to be applied when braking and steering.
- ▶ Larger steering wheel movements are required.
- ▶ The towing vehicle must not be lighter than the vehicle being towed; otherwise, it will not be possible to control the vehicle response.

Tow truck

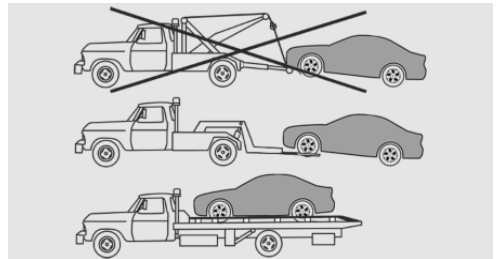

Have your vehicle transported with a tow truck with a so-called lift bar or on a flat bed.

 Do not lift the vehicle
Do not lift the vehicle by the tow fitting or body and chassis parts; otherwise, damage may result. ◀

Automatic transmission: transporting your vehicle

Note

Your vehicle is not permitted to be towed. Therefore, contact a service center in the event of a breakdown.

 Do not have the vehicle towed
Have your vehicle transported on a loading platform only; otherwise, damage may occur. ◀

Tow truck

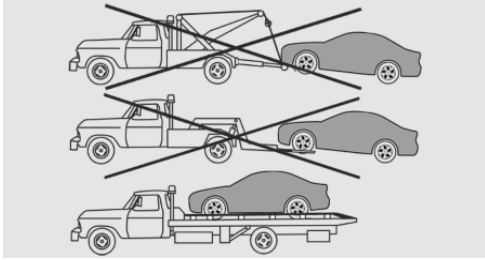



-  Do not lift the vehicle
- Do not lift the vehicle by the tow fitting or body and chassis parts; otherwise, damage may result. ◀

Use the tow fitting screwed in at the front for maneuvering the vehicle only.

Towing other vehicles

General information

-  Light towing vehicle
- The towing vehicle must not be lighter than the vehicle being towed; otherwise, it will not be possible to control the vehicle response. ◀
-  Attaching the tow bar/tow rope correctly
- Attach the tow bar or tow rope to the tow fitting; connecting it to other vehicle parts may cause damage. ◀
- ▷ Switch on the hazard warning system, depending on local regulations.
- ▷ If the electrical system has failed, clearly identify the vehicle being towed by placing a sign or a warning triangle in the rear window.

Tow bar

The tow fittings used should be on the same side on both vehicles.

Should it prove impossible to avoid mounting the tow bar at an offset angle, please observe the following:

- ▷ Maneuvering capability is limited during cornering.
- ▷ The tow bar will generate lateral forces if it is secured with an offset.

Tow rope

When starting to tow the vehicle, make sure that the tow rope is taut.

To avoid jerking and the associated stresses on the vehicle components when towing, always use nylon ropes or nylon straps.

-  Attaching the tow rope correctly
- Only secure the tow rope on the tow fitting; otherwise, damage can occur when it is secured on other parts of the vehicle. ◀

Tow fitting



The screw-in tow fitting should always be carried in the vehicle. It can be screwed in at the front or rear of the BMW. It is contained in the onboard vehicle tool kit under the cargo floor cover.

-  Tow fitting, information on use
- ▷ Use only the tow fitting provided with the vehicle and screw it all the way in.
- ▷ Use the tow fitting for towing on paved roads only.

- ▶ Avoid lateral loading of the tow fitting, e.g., do not lift the vehicle by the tow fitting.

Otherwise, damage to the tow fitting and the vehicle can occur. ◀

5. Stop at a suitable location, remove the tow bar or rope, and switch off the hazard warning system.
6. Have the vehicle checked.

Screw thread



Push out the cover by pressing on the top edge.

Tow-starting

Double-clutch transmission

Do not tow-start the vehicle.

Due to the double-clutch transmission, the engine cannot be started by tow-starting.

Have the cause of the starting difficulties remedied.

Manual transmission

If possible, do not tow-start the vehicle but start the engine by jump-starting, refer to page 192. If the vehicle is equipped with a catalytic converter, only tow-start while the engine is cold.

1. Switch on the hazard warning system and comply with local regulations.
2. Ignition, refer to page 64, on.
3. Engage third gear.
4. Have the vehicle tow-started with the clutch pressed and slowly release the clutch. After the engine starts, immediately press on the clutch again.

Care

Vehicle equipment

All standard, country-specific and optional equipment that is offered in the model series is described in this chapter. Therefore, equipment is also described that is not available in a vehicle, e. g., because of the selected optional equipment or country variant. This also applies for safety-related functions and systems.

Car washes

Hints

 Steam jets or high-pressure washers
When using steam jets or high-pressure washers, hold them a sufficient distance away and use a maximum temperature of 140 °F/60 °C.

Holding them too close or using excessively high pressures or temperatures can cause damage or preliminary damage that may then lead to long-term damage.

Follow the user's manual for the high-pressure washer. ◀

 Cleaning sensors/cameras with high-pressure washers

When using high-pressure washers, do not spray the exterior sensors and cameras, e.g., Park Distance Control, for extended periods of time and only from a distance of at least 12 in/30 cm. ◀

Regularly remove foreign items such as leaves in the area below the windshield when the hood is raised.

Wash your vehicle frequently, particularly in winter.

Intense soiling and road salt can damage the vehicle.

Automatic car washes

Hints

 Do not use high pressure washing systems

With washing systems operating at high pressures and nozzle positions close to the windows, drops of water can penetrate. ◀

Note the following:

- ▷ Give preference to cloth car washes or those that use soft brushes in order to avoid paint damage.
- ▷ Make sure that the wheels and tires are not damaged by the transport mechanisms.
- ▷ Fold in the exterior mirrors; otherwise, they may be damaged, depending on the width of the vehicle.
- ▷ Deactivate the rain sensor, refer to page 77, to avoid unintentional wiper activation.
- ▷ Do not treat the convertible top with wax. Ensure that a cycle without wax or a special cycle for convertibles is available.
- ▷ In some cases, an unintentional alarm can be triggered by the interior motion sensor of the alarm system. Follow the instructions on avoiding an unintentional alarm, refer to page 41.

 Guide rails in car washes
Avoid car washes with guide rails higher than 4 in/10 cm; otherwise, the vehicle body could be damaged. ◀

Before driving into a car wash

In order to ensure that the vehicle can roll in a car wash, take the following steps:

Manual transmission:

1. Drive into the car wash.
2. Shift to neutral.
3. Switch the engine off.
4. Switch on the ignition.

Automatic transmission:

Double-clutch transmission:

1. Drive into the car wash.
2. Engage transmission position N.
3. Switch the engine off.

In this way, the ignition remains switched on, and a Check-Control message is displayed.



Do not turn off the ignition in the car wash

Do not turn off the ignition in the car wash; otherwise, the transmission position P is engaged and damages can result. ◀

To start the engine:

1. Depress the brake pedal.
2. Press the Start/Stop button.

Pressing the Start/Stop button without stepping on the brake turns the ignition off.

The vehicle cannot be locked from the outside when in transmission position N. A signal is sounded when an attempt is made to lock the vehicle.

Transmission position

Transmission position P is engaged automatically:

- ▶ When the ignition is switched off.
- ▶ After approx. 15 minutes.

Headlamps

- ▶ Do not rub dry and do not use abrasive or caustic cleansers.

- ▶ Soak areas that have been soiled e.g. due to insects, with shampoo and wash off with water.
- ▶ Thaw ice with deicing spray; do not use an ice scraper.

After washing the vehicle

After washing the vehicle, apply the brakes briefly to dry them; otherwise, braking action can be reduced and corrosion of the brake discs can occur.

Completely remove all residues on the windows, to minimize loss of visibility due to smearing and to reduce wiper noises and wiper blade wear.

Vehicle care

Car care products

BMW recommends using cleaning and care products from BMW, since these have been tested and approved.



Car care and cleaning products

Follow the instructions on the container.

When cleaning the interior, open the doors or windows.

Only use products intended for cleaning vehicles.

Cleansers can contain substances that are dangerous and harmful to your health. ◀

Vehicle paint

Regular care contributes to driving safety and value retention. Environmental influences in areas with elevated air pollution or natural contaminants, such as tree resin or pollen can affect the vehicle's paintwork. Tailor the frequency and extent of your car care to these influences.

Aggressive substances, such as spilled fuel, oil, grease or bird droppings, must be removed

immediately to prevent the finish from being altered or discolored.

Caring for the convertible top

The appearance and life of the convertible top depend on correct care and operation.

Note the following instructions:

- ▷ To prevent water stains, mildew spots, and chafe marks, do not enclose the convertible top in the convertible top well for a long period and do not fold and stow the convertible top in the convertible top well while the top is wet or frozen.
- ▷ Remove water stains that may nevertheless have appeared on the headliner using a microfiber cloth and an interior cleaner.
- ▷ When the vehicle is parked in enclosed areas for lengthy periods, ensure that the area is well ventilated.
- ▷ If possible, park the vehicle in the shade to protect it from intensive solar radiation so that color, rubber and fabric are not affected.
- ▷ Remove bird droppings immediately as their corrosive effect will otherwise attack the convertible top and damage the rubber seals.
- ▷ Hard to remove tree sap or bird droppings can be removed from the convertible top with special tree sap remover and a soft brush.



Do not use spot remover

Do not use spot remover, paint thinner, solvent, gasoline, or similar products to remove spots on the convertible top. These products may destroy the rubber coating. Incorrect care and cleaning may cause the convertible top and its seams to become leaky. ◀

To remove heavy soiling, especially for light colored convertible tops, use a special convertible top cleaner.

Proceed as follows:

1. Spray the convertible top with the convertible top cleaner.
2. Make the convertible top cleaner foam up using a well saturated sponge, moving it in circular motions.
3. Finish washing the vehicle in the car wash or rinse with ample amounts of water.

Otherwise, follow the instructions for use from the manufacturer.

Treat the convertible top with an impregnating agent after it has been washed three to five times.

Suitable cleaners and car products can be obtained from the service department.

Leather care

Remove dust from the leather often, using a cloth or vacuum cleaner.

Otherwise, particles of dust and road grime chafe in pores and folds, and lead to increased wear and premature degradation of the leather surface.

To guard against discoloration, such as from clothing, provide leather care roughly every two months.

Clean light-colored leather more frequently because soiling on such surfaces is substantially more visible.

Use leather care products; otherwise, dirt and grease will gradually break down the protective layer of the leather surface.

Suitable care products are available from the service center.

Upholstery material care

Vacuum regularly with a vacuum cleaner.

If they are very dirty, e.g., beverage stains, use a soft sponge or microfiber cloth with a suitable interior cleaner.

Clean the upholstery down to the seams using large sweeping motions. Avoid rubbing the material vigorously.



Damage from Velcro® fasteners

Open Velcro® fasteners on pants or other articles of clothing can damage the seat covers. Ensure that any Velcro® fasteners are closed. ◀

Caring for special components

Light-alloy wheels

When cleaning the vehicle, use only neutral wheel cleaners having a pH value from 5 to 9. Do not use abrasive cleaning agents or steam jets above 140 °F/60 °C. Follow the manufacturer's instructions.

Aggressive, acidic or alkaline cleaning agents can destroy the protective layer of adjacent components, such as the brake disk.

Chrome surfaces

Carefully clean components such as the radiator grille or door handles with an ample supply of water, possibly with shampoo added, particularly when they have been exposed to road salt.

Rubber components

Aside from water, treat only with rubber cleansers.

When cleaning rubber seals, do not use any silicon-containing car care products in order to avoid damage or reduced noise damping.

Fine wood parts

Clean fine wood facing and fine wood components only with a moist rag. Then dry with a soft cloth.

Plastic components

These include:

- ▶ Imitation leather surfaces.

- ▶ Headliner.
- ▶ Lamp lenses.
- ▶ Instrument cluster cover.
- ▶ Matte black spray-coated components.
- ▶ Painted parts in the interior.

Clean with a microfiber cloth.

Lightly dampen the cloth with water.

Do not soak the headliner.



Do not use cleansers that contain alcohol or solvents

Do not use cleansers that contain alcohol or solvents, such as lacquer thinners, heavy-duty grease removers, fuel, or such; this could lead to surface damage. ◀

Safety belts

Dirty belt straps impede the reeling action and thus have a negative impact on safety.



Chemical cleaning

Do not clean chemically; this can destroy the webbing. ◀

Use only a mild soapy solution, with the safety belts clipped into their buckles.

Do not allow the reels to retract the safety belts until they are dry.

Carpets and floor mats



No objects in the area around the pedals

Keep floor mats, carpets, and any other objects out of the area of motion of the pedals; otherwise, the function of the pedals could be impeded while driving

Do not place additional floor mats over existing mats or other objects.

Only use floor mats that have been approved for the vehicle and can be properly fixed in place.

Ensure that the floor mats are securely fastened again after they were removed for cleaning, for example. ◀

Floor mats can be removed from the passenger compartment for cleaning.

If the floor carpets are very dirty, clean with a microfiber cloth and water or a textile cleaner. To prevent matting of the carpet, rub back and forth in the direction of travel only.

Sensors/cameras

To clean sensors and cameras, use a cloth moistened with a small amount of glass cleaner.

Displays/screens

Clean the displays with an antistatic microfiber cloth.



Cleaning displays

Do not use chemical or household cleansers.

Keep all fluids and moisture away from the unit.

Otherwise, they could affect or damage surfaces or electrical components.

Avoid pressing too hard when cleaning and do not use abrasive materials; otherwise, damage can result. ◀

Long-term vehicle storage

Your service center can advise you on what to consider when storing the vehicle for longer than three months.



Reference

This chapter contains the technical data and an index that will quickly take you to the information you need.

Technical data

Vehicle equipment

All standard, country-specific and optional equipment that is offered in the model series is described in this chapter. Therefore, equip-

ment is also described that is not available in a vehicle, e. g., because of the selected optional equipment or country variant. This also applies for safety-related functions and systems.

Dimensions

Width, height

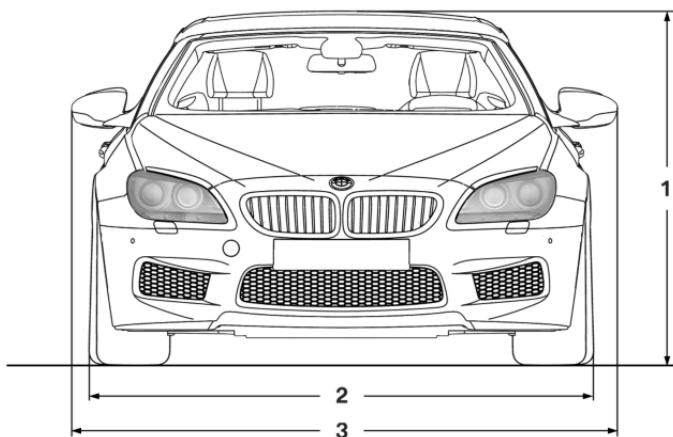

- 1** Vehicle height: 53.9 inches/1,368 mm
- 2** Vehicle height width, without mirrors: 74.8 inches/1,899 mm
- 3** Vehicle width with mirrors: 82.9 inches/2,106 mm

Length, wheel base

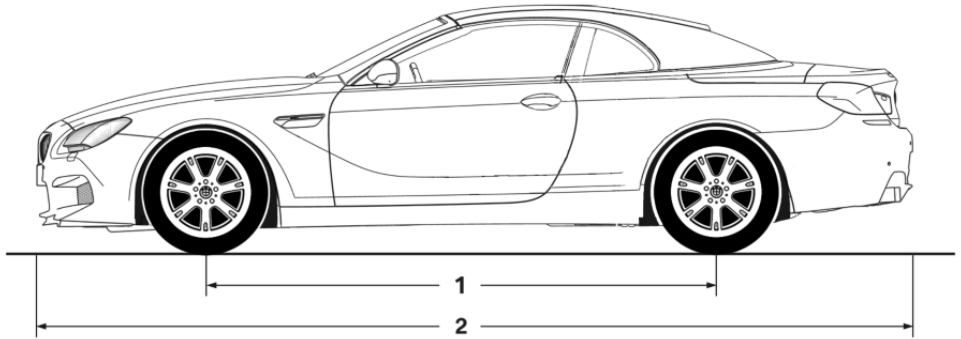

1 Wheel base: 112.2 inches/2,851 mm

2 Length: 193.0 inches/4,903 mm

Smallest turning circle

Dia.: 39.7 ft/12.1 m

Weights

The values preceding the slash apply to vehicles with manual transmission; the values following the slash apply to vehicles with double clutch transmission.

M6		
Approved gross vehicle weight	lbs/kg	5,315/2,411
Load	lbs	835/800
	kg	379/363
Approved front axle load	lbs/kg	2,645/1,200
Approved rear axle load	lbs/kg	2,780/1,261
Cargo area capacity	cu ft/l	10.6/300
With cargo area partition flipped up	cu ft/l	12.4/350

Capacities

			Notes
Fuel tank	US gal/liters	approx. 21.1/80	Fuel quality, refer to page 166
Windshield and headlamp washer system	US quarts/liters	approx. 5.3/5.0	

Everything from A to Z

Index

A

ABS, Antilock Brake System **119**
Acceleration Assistant, refer to Launch Control **73**
Activated-charcoal filter **139**
Active Blind Spot Detection **115**
Active M differential **121**
Active Protection **116**
Active seat, front **53**
Active seat ventilation, front **53**
Adaptive brake lights, refer to Brake force display **116**
Adaptive light control **94**
Additives, oil **179**
Adjusting, steering wheel **59**
Adjustments, seats/head restraints **51**
After washing vehicle **197**
Airbags **98**
Airbags, indicator/warning light **99**
Air circulation, refer to Recirculated-air mode **138**
Air distribution, manual **137**
Air drying, refer to Cooling function **138**
Air flow, automatic climate control **137**
Air pressure, tires **167**
Air vents, refer to Ventilation **139**
Alarm system **40**
Alarm, unintentional **41**
All around the center console **14**
All around the interior rear-view mirror **15**
All around the steering wheel **12**
All-season tires, refer to Winter tires **172**
Alternating-code hand-held transmitter **142**
Alternative oil types **179**
Ambient light **96**
Antifreeze, washer fluid **78**
Antilock Brake System, ABS **119**
Anti-slip control, refer to DSC **119**
Approved engine oils **179**
Armrest, refer to Front center armrest **147**
Arrival time **90**
Ashtray **143**
Assistance, Roadside Assistance **191**
Assistance when driving off **119**
Attentiveness assistant **117**
AUTO intensity **137**
Automatic car wash **196**
Automatic Curb Monitor **58**
Automatic deactivation, front passenger airbags **100**
Automatic headlamp control **94**
Automatic locking **39**
Automatic recirculated-air control **138**
Automatic Soft Closing, doors **37**
AUTO program, automatic climate control **137**
AUTO program, intensity **137**
Auto Start/Stop function **66**
Average fuel consumption **89**
Average speed **89**

Axle loads, weights **205**

B

Backrest curvature, refer to Lumbar support **52**
Backrest, seats **51**
Backrest, width **52**
Backup camera **127**
Band-aids, refer to First aid kit **191**
Bar for tow-starting/towing **194**
Battery replacement, vehicle battery **188**
Battery replacement, vehicle remote control **30**
Battery, vehicle **188**
Belts, safety belts **54**
Beverage holder, cupholder **148**
BMW Assist, see user's manual for Navigation, Entertainment and Communication
BMW Homepage **6**
BMW Internet page **6**
BMW maintenance system **182**
BMW M technology **152**
Bottle holder, refer to Cupholder **148**
Brake assistant **119**
Brake discs, breaking in **154**
Brake force display **116**
Brake lamps, brake force display **116**
Brake lamps, bulb replacement **186**
Brake lights, adaptive **116**
Brake pads, breaking in **154**

Braking, hints [156](#)
Breakdown assistance [190](#), [191](#)
Breaking in [154](#)
Brightness of Control Display [92](#)
Bulb replacement, front [184](#)
Bulb replacement, rear [186](#)
Button, Start/Stop [64](#)
Bypassing, refer to Jump-starting [192](#)

C

California Proposition 65 Warning [7](#)
Calling up mirror adjustment [40](#)
Calling up seat adjustment [40](#)
Calling up steering wheel adjustment [40](#)
Camera, backup camera [128](#)
Camera, care [200](#)
Camera, Side View [132](#)
Camera, Top View [131](#)
Can holder, refer to Cupholder [148](#)
Car battery [188](#)
Carbon ceramic brake M [152](#)
Car care products [197](#)
Care, displays [200](#)
Care, vehicle [197](#)
Cargo [158](#)
Cargo area lid [37](#)
Cargo area partition [45](#)
Cargo area, storage compartments [148](#)
Cargo, securing [159](#)
Cargo straps, securing cargo [159](#)
Car key, refer to Remote control [30](#)
Carpet, care [199](#)
Car wash [196](#)
Catalytic converter, refer to Hot exhaust system [155](#)
CBS Condition Based Service [182](#)
CD/Multimedia, see user's manual for Navigation, Entertainment and Communication
Center console [14](#)
Center-Lock, see button for central locking [33](#)
Central locking system [33](#)
Central screen, refer to Control Display [16](#)
Ceramic brake [152](#)
Changes, technical, refer to Safety [7](#)
Changing parts [184](#)
Changing wheels [187](#)
Changing wheels/tires [171](#)
Check Control [80](#)
Checking the oil level electronically [178](#)
Children, seating position [61](#)
Children, transporting safely [61](#)
Child restraint fixing system [61](#)
Child restraint fixing system LATCH [62](#)
Child restraint fixing systems, mounting [61](#)
Child seat, mounting [61](#)
Child seats [61](#)
Chrome parts, care [199](#)
Cigarette lighter [143](#)
Cleaning, displays [200](#)
Climate control [136](#)
Climate control windshield [155](#)
Clock [83](#)
Closing/opening from inside [36](#)
Closing/opening via door lock [36](#)
Closing/opening with remote control [34](#)
Collision warning with City Braking function [106](#)
Combination switch, refer to Turn signals [75](#)
Combination switch, refer to Wiper system [76](#)
Comfort Access [38](#)
Compound brake [152](#)
Compressor [172](#)
Computer [89](#)
Condensation on windows [138](#)
Condensation under the vehicle [157](#)
Condition Based Service CBS [182](#)
Confirmation signal [39](#)
ConnectedDrive, see user's manual for Navigation, Entertainment and Communication
ConnectedDrive Services Control Display [16](#)
Control Display, settings [91](#)
Controller [16](#)
Control systems, driving stability [119](#)
Convenient closing [34](#)
Convenient opening [34](#)
Convertible, convertible top [43](#)
Convertible mode, automatic climate control [137](#)
Convertible program, automatic climate control [137](#)
Convertible top [43](#)
Convertible top, care [198](#)
Convertible top, cargo area partition [45](#)
Convertible top, emergency operation [46](#)
Convertible top, rollover protection system [101](#)
Convertible top tool [46](#)

Coolant 181
Coolant temperature 83
Cooling function 138
Cooling, maximum 138
Cooling system 181
Corrosion on brake discs 156
Cruise control 123
Cruising range 84
Cupholder 148
Current fuel consumption 84

D

Damage, tires 170
Damper control 121
Damper Control, Electronic 121
Data, technical 204
Date 83
Daytime running lights 94
Defrosting, refer to Windows, defrosting 138
Departure time, parked-car ventilation 140
Destination distance 89
Differential lock 121
Digital clock 83
Digital speed 83
Digital tachometer 83
Dimensions 204
Dimmable exterior mirrors 58
Dimmable interior rearview mirror 58
Direction indicator, refer to Turn signals 75
Display in windshield 133
Display lighting, refer to Instrument lighting 96
Displays 79
Displays, cleaning 200
Disposal, coolant 181
Disposal, vehicle battery 188
Distance control, refer to PDC 125
Distance to destination 89
Divided screen view, split screen 20
Door lock, refer to Remote control 30
Doors, Automatic Soft Closing 37
Double-clutch transmission 70
Drivelogic 72
Drive mode 71
Drive-off assistant 119
Drive-off assistant, refer to DSC 119
Driver assistance, see Intelligent Safety 105
Driving Assistant, see Intelligent Safety 105
Driving Dynamics Control 74
Driving Dynamics System 85
Driving dynamics, system states 85
Driving instructions, breaking in 154
Driving notes, general 155
Driving on racetracks 153
Driving program, refer to Drivelogic 72
Driving stability control systems 119
Driving tips 155
DSC Dynamic Stability Control 119
Dynamic Stability Control DSC 119

E

EDC, Electronic Damper Control 121
EfficientDynamics 85
EfficientDynamics display 85
EfficientDynamics menu 85
Electronic Damper Control EDC 121
Electronic displays, instrument cluster 80
Electronic Stability Program ESP, refer to DSC 119
Emergency detection, remote control 31
Emergency operation, convertible top 46
Emergency release, door lock 36
Emergency release, fuel filler flap 164
Emergency Request 190
Emergency service, refer to Roadside Assistance 191
Emergency start function, engine start 31
Emergency unlocking, trunk lid 38
Energy Control 84
Energy recovery 84
Engine, automatic Start/Stop function 66
Engine, automatic switch-off 66
Engine compartment 176
Engine compartment, working in 176
Engine coolant 181
Engine oil 178
Engine oil, adding 179
Engine oil additives 179
Engine oil change 180
Engine oil filler neck 179
Engine oil temperature 82
Engine oil types, alternative 179
Engine oil types, approved 179
Engine start during malfunction 31
Engine start, jump-starting 192
Engine start, refer to Starting the engine 65
Engine stop 66
Engine temperature 82

Entering/exiting vehicle, assistance, steering wheel [59](#)
Entering a car wash [196](#)
Equipment, interior [141](#)
ESP Electronic Stability Program, refer to DSC [119](#)
Exchanging wheels/tires [171](#)
Exhaust system [155](#)
Exterior mirror, automatic dimming feature [58](#)
Exterior mirrors [57](#)
External start [192](#)
External temperature display [83](#)
External temperature warning [83](#)
Eyes for securing cargo [159](#)

F

Failure message, refer to Check Control [80](#)
False alarm, refer to Unintentional alarm [41](#)
Fan, refer to Air flow [137](#)
Fault displays, refer to Check Control [80](#)
Filler neck for engine oil [179](#)
Fine wood, care [199](#)
First aid kit [191](#)
Fitting for towing, refer to Tow fitting [194](#)
Flat tire, changing wheels [187](#)
Flat Tire Monitor FTM [104](#)
Flat tire, repairing [172](#)
Flat tire, Tire Pressure Monitor TPM [102](#)
Flat tire, warning lamp [103](#), [105](#)
Flooding [156](#)
Floor carpet, care [199](#)
Floor mats, care [199](#)
Fold-out position, windshield wipers [77](#)
Foot brake [156](#)
Front airbags [98](#)
Front center armrest [147](#)
Front lamps [184](#)
Front passenger airbags, automatic deactivation [100](#)
Front passenger airbags, indicator lamp [100](#)
Front seats [51](#)
Front turn signals, refer to Light-emitting diodes, LEDs [185](#)
FTM Flat Tire Monitor [104](#)
Fuel [166](#)
Fuel cap [164](#)
Fuel consumption, current [84](#)
Fuel consumption, refer to Average fuel consumption [89](#)
Fuel filler flap [164](#)
Fuel gauge [82](#)
Fuel quality [166](#)
Fuel recommendation [166](#)
Fuel, tank capacity [206](#)
Fuse [188](#)

G

Garage door opener, refer to Integrated universal remote control [141](#)
Gasoline [166](#)
Gasoline quality [166](#)
Gear change [71](#)
Gear shift indicator [86](#)
General driving notes [155](#)
Glove compartment [146](#)
Gross vehicle weight, approved [205](#)
Gross weight, permissible for trailer towing [205](#)
Ground clearance [157](#)

H

Handbrake, refer to Parking brake [68](#)

Hand-held transmitter, alternating code [142](#)
Hazard warning flashers [190](#)
Headlamp control, automatic [94](#)
Headlamp courtesy delay feature [93](#)
Headlamp courtesy delay feature via remote control [35](#)
Headlamp flasher [76](#)
Headlamp glass [185](#)
Headlamps [184](#)
Headlamps, care [197](#)
Headlamp washer system [76](#)
Head restraints [51](#)
Head restraints, front [55](#)
Head-Up Display [133](#)
Head-up Display, care [200](#)
Head-up display, M view [134](#)
Head-up display, standard view [134](#)
Heavy cargo, stowing [159](#)
Height, seats [51](#)
Height, vehicle [204](#)
High-beam Assistant [95](#)
High beams [76](#)
High beams/low beams, refer to High-beam Assistant [95](#)
Higher speed range [157](#)
Hills [156](#)
Hill Start Assistant [121](#)
Hill start assistant, refer to Drive-off assistant [119](#)
Hints [6](#)
Holder for beverages [148](#)
Homepage [6](#)
Hood [176](#)
Horn [12](#)
Hotel function, trunk lid [37](#)
Hot exhaust system [155](#)
HUD Head-Up Display [133](#)
Hydroplaning [155](#)

I

Ice warning, refer to External temperature warning [83](#)

Icy roads, refer to External temperature warning [83](#)

Identification marks, tires [169](#)

Identification number, refer to Important features in the engine compartment [176](#)

iDrive [16](#)

Ignition key, refer to Remote control [30](#)

Ignition off [64](#)

Ignition on [64](#)

Indication of a flat tire [103](#), [105](#)

Indicator and warning lamps [80](#)

Individual air distribution [137](#)

Individual settings, refer to M Drive [59](#)

Individual settings, refer to Personal Profile [31](#)

Inflation pressure, tires [167](#)

Inflation pressure warning FTM, tires [104](#)

Info display, refer to Computer [89](#)

Initialize, Tire Pressure Monitor TPM [103](#)

Initializing, Flat Tire Monitor FTM [104](#)

Instrument cluster [79](#)

Instrument cluster, electronic displays [80](#)

Instrument lighting [96](#)

Integrated key [30](#)

Integrated universal remote control [141](#)

Intelligent Emergency Request [190](#)

Intelligent Safety [105](#)

Intensity, AUTO program [137](#)

Interior equipment [141](#)

Interior lamps [96](#)

Interior lamps via remote control [35](#)

Interior motion sensor [41](#)

Interior rearview mirror, automatic dimming feature [58](#)

Internet page [6](#)

Interval display, service requirements [85](#)

J

Jacking points for the vehicle jack [187](#)

Jump-starting [192](#)

K

Key/remote control [30](#)

Keyless Go, refer to Comfort Access [38](#)

Key Memory, refer to Personal Profile [31](#)

Knee airbag [98](#)

L

Lamp replacement, front [184](#)

Lamp replacement, rear [186](#)

Lamps [93](#)

Lamps and bulbs [184](#)

Lane departure warning [113](#)

Lane margin, warning [113](#)

Language on Control Display [91](#)

Lashing eyes, securing cargo [159](#)

LATCH child restraint fixing system [62](#)

Launch Control [73](#)

Leather, care [198](#)

LED headlamps, Bulb replacement [186](#)

LED light [186](#)

LEDs, light-emitting diodes [185](#)

Length, vehicle [205](#)

Letters and numbers, entering [21](#)

License plate lamp, bulb replacement [186](#)

Light alloy wheels, care [199](#)

Light control [94](#)

Light-emitting diodes, LEDs [185](#)

Lighting [93](#)

Lighting, speaker [97](#)

Lighting via remote control [35](#)

Light switch [93](#)

Load [158](#)

Loading [158](#)

Lock, door [36](#)

Locking/unlocking from inside [36](#)

Locking/unlocking via door lock [36](#)

Locking/unlocking with remote control [34](#)

Locking, automatic [39](#)

Locking, central [33](#)

Locking, settings [39](#)

Locking via trunk lid [37](#)

Low beams [93](#)

Low beams, automatic, refer to High-beam Assistant [95](#)

Lower back support [52](#)

Low Speed Assistant [74](#)

Lumbar support [52](#)

M

Maintenance [182](#)

Maintenance requirements [182](#)

Maintenance, service requirements [85](#)

Maintenance system, BMW [182](#)

Malfunction displays, refer to Check Control [80](#)

Manual air distribution [137](#)

Manual air flow [137](#)
Manual brake, refer to Parking brake [68](#)
Manual operation, backup camera [128](#)
Manual operation, door lock [36](#)
Manual operation, exterior mirrors [58](#)
Manual operation, fuel filler flap [164](#)
Manual operation, Park Distance Control PDC [126](#)
Manual operation, Side View [133](#)
Manual operation, Top View [131](#)
Marking on approved tires [171](#)
Massage seat, front [53](#)
Master key, refer to Remote control [30](#)
Maximum cooling [138](#)
Maximum speed, display [87](#)
Maximum speed, winter tires [172](#)
M carbon ceramic brake [152](#)
M Compound brake [152](#)
M differential, active [121](#)
MDM, M Dynamic Mode [120](#)
M double-clutch transmission [70](#)
M Drive [59](#)
M Driver's Package, driving instructions [157](#)
M Driving Dynamics Control [74](#)
M Dynamic Mode MDM [120](#)
Measure, units of [91](#)
Medical kit [191](#)
Memory for seat, mirrors, steering wheel [56](#)
Menu in instrument cluster [88](#)
Menus, operating, iDrive [16](#)

Menus, refer to iDrive operating concept [17](#)
Messages, refer to Check Control [80](#)
Microfilter [139](#)
Minimum tread, tires [170](#)
Mirror [57](#)
Mirror memory [56](#)
Mobile communication devices in the vehicle [155](#)
Mobility System [172](#)
Modifications, technical, refer to Safety [7](#)
Moisture in headlamp [185](#)
Monitor, refer to Control Display [16](#)
Mounting of child restraint fixing systems [61](#)
M technology [152](#)
Multifunction steering wheel, buttons [12](#)
M view, head-up display [134](#)

N

Navigation, see user's manual for Navigation, Entertainment and Communication
Neck restraints, front, refer to Head restraints [55](#)
Neutral cleaner, see wheel cleaner [199](#)
New wheels and tires [171](#)
Night Vision with pedestrian detection [110](#)
No Passing Information [87](#)
Nylon rope for tow-starting/towing [194](#)

O

OBD Onboard Diagnosis [183](#)
OBD, see OBD Onboard Diagnosis [183](#)
Obstacle marking, rearview camera [129](#)

Octane rating, refer to Gasoline quality [166](#)
Odometer [83](#)
Office, see user's manual for Navigation, Entertainment and Communication
Oil [178](#)
Oil, adding [179](#)
Oil additives [179](#)
Oil change [180](#)
Oil change interval, service requirements [85](#)
Oil filler neck [179](#)
Oil types, alternative [179](#)
Oil types, approved [179](#)
Old batteries, disposal [188](#)
Onboard monitor, refer to Control Display [16](#)
Onboard vehicle tool kit [184](#)
Opening and closing [30](#)
Opening and closing, from inside [36](#)
Opening and closing via door lock [36](#)
Opening and closing, with remote control [34](#)
Operating concept, iDrive [16](#)
Optional equipment, standard equipment [6](#)
Outside air, refer to Automatic recirculated-air control [138](#)
Overheating of engine, refer to Coolant temperature [83](#)
Overtaking prohibitions [87](#)

P

Paint, vehicle [197](#)
Park Distance Control PDC [125](#)
Parked-car ventilation [140](#)
Parked vehicle, condensation [157](#)
Parking aid, refer to PDC [125](#)
Parking brake [68](#)

- Parking lamps [93](#)
Parking lamps and roadside parking lamps, refer to Light-emitting diodes, LEDs [185](#)
Passenger side mirror, tilting downward [58](#)
Pathway lines, rearview camera [129](#)
PDC Park Distance Control [125](#)
Pedestrian detection, refer to Night Vision [110](#)
Pedestrian warning with city braking function [108](#)
People detection, refer to Night Vision [110](#)
Permissible axle load [205](#)
Personal Profile [31](#)
Pinch protection system, windows [43](#)
Plastic, care [199](#)
Power failure [188](#)
Power windows [41](#)
Pressure, tire air pressure [167](#)
Pressure warning FTM, tires [104](#)
Preventing Auto Start Stop [67](#)
Profile, refer to Personal Profile [31](#)
Programmable memory buttons, iDrive [20](#)
Protective function, windows [43](#)
Push-and-turn switch, refer to Controller [16](#)
- ## R
- Radiator fluid [181](#)
Radio-operated key, refer to Remote control [30](#)
Radio ready state [65](#)
Radio, see user's manual for Navigation, Entertainment and Communication
Rain sensor [76](#)
Rear lamps [186](#)
Rearview mirror [57](#)
Rear window defroster [138](#)
Recirculated-air mode [138](#)
Recommended tire brands [171](#)
Refueling [164](#)
Remaining range [84](#)
Remote control/key [30](#)
Remote control, malfunction [35](#)
Remote control, universal [141](#)
Replacement fuse [188](#)
Replacing bulbs, see Lamp replacement [184](#)
Replacing parts [184](#)
Replacing wheels/tires [171](#)
Reporting safety defects [9](#)
Reserve warning, refer to Range [84](#)
Reset, Tire Pressure Monitor TPM [103](#)
Residual heat, automatic climate control [139](#)
Retaining straps, securing cargo [159](#)
Retreaded tires [172](#)
Reversing lamp, bulb replacement [187](#)
Roadside parking lamps [94](#)
Rollover protection system [101](#)
RON gasoline quality [166](#)
Rope for tow-starting/towing [194](#)
Rubber components, care [199](#)
- ## S
- Safe braking [156](#)
Safety [7](#)
Safety belt reminder for driver's seat and front passenger seat [54](#)
Safety belts [54](#)
Safety belts, care [199](#)
Safety Package, refer to Active Protection [116](#)
Safety systems, airbags [98](#)
Saving fuel [160](#)
Screen, refer to Control Display [16](#)
Screwdriver [184](#)
Screw thread for tow fitting [195](#)
Sealant [172](#)
Seat belts, refer to Safety belts [54](#)
Seat heating, front [53](#)
Seating position for children [61](#)
Seat, mirror, and steering wheel memory [56](#)
Seats [51](#)
Seat ventilation, front [53](#)
Selection list in instrument cluster [88](#)
Selector lever [70](#)
Sensors, care [200](#)
Sequential mode [71](#)
Service and warranty [7](#)
Service requirements, Condition Based Service CBS [182](#)
Service requirements, display [85](#)
Service, Roadside Assistance [191](#)
Services, ConnectedDrive Servotronic [122](#)
Settings, locking/unlocking [39](#)
Settings, M Drive [59](#)
Settings on Control Display [91](#)

- Settings, storing for seat, mirrors, steering wheel **56**
- Shift Lights **73**
- Shoulder support **53**
- Side airbags **98**
- Side View **132**
- Signaling, horn **12**
- Signals when unlocking **39**
- Sitting safely **51**
- Size **204**
- Ski bag **145**
- Smallest turning circle **205**
- Smoker's package **143**
- Snow chains **175**
- Socket **144**
- Socket, OBD Onboard Diagnostics **183**
- SOS button **190**
- Spare fuse **188**
- Speaker lighting **97**
- Specified engine oil types **179**
- Speed, average **89**
- Speed limit detection, on-board computer **90**
- Speed limiter, display **87**
- Speed Limit Information **87**
- Speed limit in the computer **90**
- Split screen **20**
- Stability control systems **119**
- Standard view, head-up display **134**
- Start/stop, automatic function **66**
- Start/Stop button **64**
- Start function during malfunction **31**
- Starting the engine **65**
- Status display, tires **102**
- Status information, iDrive **19**
- Status of Owner's Manual **6**
- Steering assistance **122**
- Steering wheel, adjusting **59**
- Steering wheel heating **59**
- Steering wheel memory **56**
- Stopping the engine **66**
- Storage compartments **146**
- Storage compartments, locations **146**
- Storage, tires **172**
- Storing the vehicle **200**
- Summer tires, tread **170**
- Supplementary text message **81**
- Surround View **127**
- Switch, refer to Cockpit **12**
- Symbols **6**
- SYNC program, automatic climate control **138**
- System states of the driving dynamics **85**
- ## T
- Tachometer **82**
- Tail and brake lamps **186**
- Tailgate **37**
- Tailgate via remote control **35**
- Tail lamps **186**
- Tail lamps, bulb replacement **186**
- Technical changes, refer to Safety **7**
- Technical data **204**
- Technology, BMW M **152**
- Telephone, see user's manual for Navigation, Entertainment and Communication
- Temperature, automatic climate control **137**
- Temperature display, external temperature **83**
- Temperature, engine oil **82**
- Terminal, starting aid **192**
- Text message, supplementary **81**
- Theft alarm system, refer to Alarm system **40**
- Theft protection, refer to Central locking system **33**
- Thermal camera, refer to Night Vision **110**
- Thigh support **52**
- Tilt alarm sensor **41**
- Tilt, seats **51**
- Time of arrival **90**
- Tire damage **170**
- Tire identification marks **169**
- Tire inflation pressure **167**
- Tire inflation pressure monitor, refer to FTM **104**
- Tire Pressure Monitor TPM **102**
- Tires, changing **171**
- Tire sealant **172**
- Tires, everything on wheels and tires **167**
- Tire tread **170**
- Tone, see user's manual for Navigation, Entertainment and Communication
- Tools **184**
- Top View **130**
- Total vehicle weight **205**
- Tow fitting **194**
- Towing **193**
- Tow-starting **193**
- Tow truck **193**
- TPM Tire Pressure Monitor **102**
- Transmission positions **70**
- Transporting children safely **61**
- Tread, tires **170**
- Trip computer **90**
- Triple turn signal activation **75**
- Trip odometer **83**
- Truck for tow-starting/towing **193**
- Trunk, cargo area partition **45**
- Trunk lid **37**
- Trunk lid, emergency unlocking **38**
- Trunk lid, hotel function **37**

Trunk lid via remote control [35](#)
Turning circle [205](#)
Turning circle lines, rearview camera [129](#)
Turn signals, operation [75](#)
Turn signals, rear, bulb replacement [186](#)

U

Unintentional alarm [41](#)
Units of measure [91](#)
Universal remote control [141](#)
Unlocking/locking from inside [36](#)
Unlocking/locking via door lock [36](#)
Unlocking/locking with remote control [34](#)
Unlocking, settings [39](#)
Updates made after the editorial deadline [7](#)
Upholstery care [198](#)
USB interface [146](#)

V

V8 high-performance engine, High-performance engine V8 [152](#)
Vehicle battery [188](#)
Vehicle battery, replacing [188](#)
Vehicle, breaking in [154](#)
Vehicle care [197](#)
Vehicle equipment [6](#)
Vehicle identification number, refer to Identification number in the engine compartment [176](#)
Vehicle jack [187](#)
Vehicle paint [197](#)
Vehicle storage [200](#)
Vehicle wash [196](#)
Ventilation [139](#)

Ventilation, refer to Parked-car ventilation [140](#)
Voice activation system [22](#)

W

Warning indicators [80](#)
Warning lamps [80](#)
Warning messages, refer to Check Control [80](#)
Warning triangle [191](#)
Washer fluid [78](#)
Washer fluid reservoir, capacity [206](#)
Washer nozzles, windshield [77](#)
Washer system [76](#)
Washing, vehicle [196](#)
Water on roads [156](#)
Weights [205](#)
Welcome lamps [93](#)
Wheel base, vehicle [205](#)
Wheel cleaner [199](#)
Wheels, changing [171](#)
Wheels, everything on wheels and tires [167](#)
Wheels, Flat Tire Monitor FTM [104](#)
Wheels, Tire Pressure Monitor TPM [102](#)
Width, vehicle [204](#)
Wind deflector [49](#)
Window defroster, rear [138](#)
Windows, powered [41](#)
Windshield, climate control [155](#)
Windshield washer fluid [78](#)
Windshield washer nozzles [77](#)
Windshield washer system [76](#)
Windshield wiper [76](#)
Windshield wipers, fold-out position [77](#)
Winter storage, care [200](#)

Winter tires, suitable tires [172](#)
Winter tires, tread [170](#)
Wiper blades, replacing [184](#)
Wiper fluid [78](#)
Wiper system [76](#)
Wood, care [199](#)
Word match concept, navigation [21](#)
Wrench [184](#)

X

Xenon headlamps, bulb replacement [185](#)

More about BMW



The Ultimate Driving
Machine

bmwusa.com

01 40 2 926 037 ue

