

Contents

A - Z

Owner's Manual
for Vehicle



The Ultimate
Driving Machine



THE BMW M3.

OWNER'S MANUAL.

BMW M. 

3 Series **M3** **Owner's Manual for Vehicle**

Congratulations, and thank you for choosing a BMW.

Thorough familiarity with your vehicle will provide you with enhanced control and security when you drive it. We therefore have this request:

Please take the time to read this Owner's Manual and familiarize yourself with the information that we have compiled for you before starting off in your new vehicle. It contains important data and instructions intended to assist you in gaining maximum use and satisfaction from your BMW's unique range of technical features. The manual also contains information on maintenance designed to enhance operating safety and contribute to maintaining the value of your BMW throughout an extended service life.

This manual is supplemented by a Service and Warranty Information Booklet for US models or a Warranty and Service Guide Booklet for Canadian models.

Please also read the other booklets of vehicle literature, e.g. the Supplementary Owner's Handbook for the BMW M3.

We wish you an enjoyable driving experience.

BMW AG

© 2013 Bayerische Motoren Werke
Aktiengesellschaft
Munich, Germany
Reprinting, including excerpts, only with the
written consent of BMW AG, Munich.
US English VI/13, 07 13 500
Printed on environmentally friendly paper,
bleached without chlorine, suitable for recycling.

ADDENDUM TO BMW M3 OWNER'S MANUAL 1402911406

We wanted to provide you with some updates and clarifications with respect to the printed BMW Owner's Manual. These updates and clarifications will supersede the materials contained in that document.

1. Where the terms "service center," "the service center," "your service center," "service specialist," or "service" are used in the Owner's Manual, we wanted to clarify that the terms refer to a BMW dealer's service center or another service center or repair shop that employs trained personnel that can perform maintenance and repair work on your vehicle in accordance with BMW specifications.
2. Where the text of the Owner's Manual contains an affirmative instruction to contact a "service center" or "your service center," we wanted to clarify that BMW recommends that, if you are faced with one of the situations addressed by that text, you contact or seek the assistance of a BMW dealer's service center or another service center or repair shop that employs trained personnel that can perform maintenance and repair work on your vehicle in accordance with BMW specifications.

While BMW of North America LLC, at no cost to you, will pay for repairs required by the limited warranties provided with respect to your

vehicle and for maintenance under the Maintenance Program during the applicable warranty and maintenance coverage periods, you are free to elect, both during those periods and thereafter, to have maintenance and repair work provided by other service centers or repair shops.

3. Where the Owner's Manual makes reference to parts and accessories having been approved by BMW, those references are intended to reflect that those parts and accessories are recommended by BMW of North America LLC. You may elect to use other parts and accessories, but, if you do, we recommend that you make sure that any such parts and/or accessories are appropriate for use on your vehicle.
4. At page 5, under the warranty section's discussion of homologation, where it states that you "cannot lodge warranty claims for your vehicle there," the text should read that you "may not be able to lodge warranty claims for your vehicle there."
5. At page 5, in the "Parts and Accessories" section, the sentence beginning "For your own safety, use . . . ," should be disregarded and the following the text should be read in lieu thereof: "The manufacturer of your vehicle recommends using

genuine parts and accessories approved by BMW.”

In the fifth sentence of that paragraph, the word “cannot” should read “does not.”

6. At page 51, under the heading: “Front active head restraints,” the text beginning, “Attach only BMW approved accessories . . .” should be disregarded and the following text should be read in lieu thereof: “BMW recommends that you attach accessories approved by BMW to the seat or head restraint.”
7. At page 54, in the “Damage to safety belts” section, the text beginning, “Have this work carried out only at your BMW center. . . .” should be disregarded and the following text should be read in lieu thereof: “BMW recommends having this work performed by a service center as it is important that this safety feature functions properly.”
8. At page 138 under the heading: “Objects in the movement range of the pedals” and at page 264 under the heading: “Carpet and floor mats,” the paragraph that begins: “Only use floor mats . . .” should be disregarded and the following language should be read in lieu thereof: “The manufacturer of your vehicle recommends that you use floor mats that have been identified by it as appropriate for use in your vehicle and that can be properly fixed in place.”
9. At page 228, under the heading “Apps” and subheading “Requirements,” the section that begins, “To avoid malfunction, only use . . . ,” should be disregarded and the following text should be read in lieu thereof: “The manufacturer of your vehicle recommends the use of BMW recommended software; otherwise there may be malfunctions in system operations.”
10. At page 252, under the heading: “Correct wheels and tires,” the term “Correct” should be disregarded and in lieu thereof, the term “Recommended” should be read in its place. In addition, the text of that section should be disregarded and the following text should be read in lieu thereof:

When mounting new tires or changing over from summer to winter tires and vice versa, BMW recommends that you mount run-flat tires. In the event of a flat, no spare wheel is available. Your BMW center will be glad to advise you.

The manufacturer of your vehicle strongly suggests that you use wheels and tires that have been recommended by the vehicle manufacturer for your vehicle type; otherwise, for example, despite having the same official size ratings, variations can lead to body contact and with it, the risk of severe accidents. The manufacturer of your vehicle does not evaluate non-recommended wheels and tires to

determine if they are suitable for use on your vehicle.

You can inquire about the recommended wheel/tire combination at your BMW center.

The recommended combination of wheels and tires will help ensure reliable operation of various vehicle systems such as ABS, DSC or FTM.

To maintain good handling and vehicle response, BMW recommends that you use tires of a single brand and tread configuration. After a tire has been damaged, mount the previous wheel and tire combination again as soon as possible.

11. At page 254, under the heading: "Snow Chains," the text should be disregarded and the following text should be read in lieu thereof:

Only certain types of fine-link snow chains have been tested by the manufacturer of your vehicle and are determined by the manufacturer of your vehicle to be road safe and are recommended by the manufacturer of your vehicle.

Information about recommended snow chains is available from a service center.

12. At page 255, under the heading "Hood," the sentence beginning "If you are not familiar . . ." should be disregarded and the following text should be read in lieu thereof: "If

this work is not carried out properly, there is a danger of subsequent damage and related safety hazards."

13. At page 259, under the heading: "Approved oil grades," the references to "Approved" should be read as "Suitable." Immediately preceding the "Gasoline engine" chart, the following sentence should be inserted: "Add engine oils that meet the following oil rating standards: . . ." The reference to "BMW High Performance SAE 5W-30" should be disregarded.
14. At page 259, under the heading: "Alternative oil types," the text preceding the chart should be disregarded, and in lieu thereof should be read as follows: "If an engine oil suitable for continuous use is not available, up to 1 US quart/liter of an engine oil with the following oil rating can be added: . . ." The reference to "specification" should be read as "rating."
15. At page 259, under the heading: "Oil change," the text should be disregarded and in lieu thereof should be read as follows:

BMW recommends that you have the oil changed at your BMW dealer's service center or at another service center that has trained personnel that can perform the work in accordance with BMW specifications
16. At page 260, under the heading: "Service and Warranty Information

Booklet for US models and Warranty and Service Guide Booklet for Canadian models,” the second paragraph should be disregarded and the following text read in lieu thereof:

The manufacturer of your vehicle recommends that you have maintenance and repair performed by your BMW dealer’s service center or another service center or repair shop that employs trained personnel that can perform maintenance and repair work on your vehicle in accordance with BMW specifications. The manufacturer of your vehicle recommends that you maintain records of all maintenance and repair work performed on your vehicle.

17. At page 267, under the heading “Xenon lamps,” where it reads: “[h]ave all work on the xenon lamp system . . . ,” the following words should be read as preceding that passage: “It is strongly suggested that you”
18. At page 270, under the “Battery replacing” section, the text should be disregarded and in lieu thereof the following text should be read:

Use of recommended vehicle batteries

The manufacturer of your vehicle recommends that you use vehicle batteries that it has tested and recommends for use in your vehicle; otherwise the vehicle could be

damaged and systems or functions may not be fully available.

After a battery replacement, the manufacturer of your vehicle recommends that you have the battery registered on your vehicle by a service center to ensure that all comfort functions are fully available, and that any “check control” messages of these comfort functions are no longer displayed.

Contents

The quickest way to find special topics is to consult the index, refer to page 290.

- 4 Notes
- 7 Reporting safety defects

At a glance

- 12 Dashboard
- 20 iDrive
- 27 Voice activation system

Controls

- 32 Opening and closing
- 48 Adjustments
- 58 Transporting children safely
- 62 Driving
- 83 Controls overview
- 96 Technology for driving comfort and safety
- 110 Lamps
- 115 Climate
- 120 Practical interior accessories

Driving tips

- 136 Things to remember when driving

Navigation

- 144 Navigation system
- 146 Destination entry
- 155 Destination guidance
- 163 What to do if ...

Entertainment

- 166 On/off and tone
- 169 Radio
- 173 Satellite radio
- 178 CD/DVD player
- 184 Music collection
- 189 External devices

Communications

- 200 Telephone
- 213 Office
- 222 Contacts
- 224 ConnectedDrive

Mobility

- 232 Refueling
- 235 Wheels and tires
- 255 Engine compartment
- 260 Maintenance
- 262 Care
- 262 Washing the vehicle
- 266 Replacing components
- 272 Giving and receiving assistance

Reference

- 280 Technical data
- 283 Short commands for the voice activation system
- 290 Everything from A to Z

Notes

Using this Owner's Manual

We have tried to make all the information in this Owner's Manual easy to find. The fastest way to find specific topics is to refer to the detailed index at the back of the manual. If you wish to gain an initial overview of your vehicle, you will find this in the first chapter.

Should you sell your BMW some day, please remember to hand over the Owner's Manual as well; it is an important component of your vehicle.

Updates after press date

Updates after press date for the Owner's Manuals, when necessary, are issued as appendices to the printed Quick Reference Guide for the vehicle.

Additional sources of information

Should you have any other questions, your BMW center will be glad to advise you at any time.

Information on BMW, e.g. on technical aspects, can also be found on the Internet at www.bmwusa.com.

Symbols used



Indicates precautions that must be followed precisely in order to avoid the possibility of personal injury and serious damage to the vehicle. ◀



Indicates information that will assist you in gaining the optimum benefit from your vehicle and enable you to care more effectively for your vehicle. ◀



Refers to measures that can be taken to help protect the environment. ◀

◀ Marks the end of a specific item of information.

"..." Identifies Control Display texts used to select individual functions.

>...◀ Verbal instructions to use with the voice activation system.

>>...◀◀ Identifies the answers generated by the voice activation system.

Symbols on vehicle components



Indicates that you should consult the relevant section of this Owner's Manual for information on a particular part or assembly.

Vehicle equipment

This Owner's Manual describes all models and all series-specific equipment, country-specific equipment, and optional equipment that is offered in the series. For this reason, this Owner's Manual also describes and illustrates some equipment that may not be available in your vehicle, for example due to the special options or national-market version selected.

This also applies to safety related functions and systems.

If equipment and models are not described in this Owner's Manual, please consult the accompanying Supplementary Owner's Handbooks.

Status of this Owner's Manual at time of printing

BMW pursues a policy of continuous, ongoing development that is conceived to ensure that our vehicles continue to embody the highest quality and safety standards combined with advanced, state-of-the-art technology. For this reason, it is possible in exceptional cases that features described in this Owner's Manual could differ from those on your vehicle.

Updates after press date

Updates after press date for the Owner's Manuals, when necessary, are issued as appendices to the printed Quick Reference Guide for the vehicle.

Your own safety

Warranty

Your vehicle is technically configured for the operating conditions and registration requirements applying in the country of first delivery – homologation. If your vehicle is to be operated in a different country it might be necessary to adapt your vehicle to potentially differing oper-

ating conditions and permit requirements. If your vehicle does not comply with the homologation requirements in a certain country you cannot lodge warranty claims for your vehicle there.

Further information can be obtained from your service center.

Maintenance and repair



Advanced technology, e.g. the use of modern materials and powerful electronics, requires specially adapted maintenance and repair methods. You should therefore have the corresponding work on your vehicle performed only by your BMW center or at a workshop that works according to BMW repair procedures with correspondingly trained personnel. If this work is not carried out properly, there is a danger of subsequent damage and related safety hazards. ◀

Parts and accessories



For your own safety, use genuine parts and accessories approved by BMW.

When you purchase accessories tested and approved by BMW and Original BMW Parts, you simultaneously acquire the assurance that they have been thoroughly tested by BMW to ensure optimum performance when installed on your vehicle.

BMW warrants these parts to be free from defects in material and workmanship.

BMW will not accept any liability for damage resulting from installation of parts and accessories not approved by BMW.

BMW cannot test every product made by other manufacturers to verify if it can be used on a BMW safely and without risk to either the vehicle, its operation, or its occupants.

Original BMW Parts, BMW Accessories and other products approved by BMW, together with professional advice on using these items, are available from all BMW centers.

Installation and operation of accessories not approved by BMW, such as alarms, radios, amplifiers, radar detectors, wheels, suspension components, brake dust shields, telephones, including operation of any mobile phone from within the vehicle without using an externally mounted antenna, or transceiver equipment, for instance, CBs, walkie-talkies, ham radio or similar accessories, may cause extensive damage to the vehicle, compromise its safety, interfere with the vehicle's electrical system or affect the validity of the BMW Limited Warranty. See your BMW center for additional information. ◀



Maintenance, replacement, or repair of the emission control devices and systems may be performed by any automotive repair establishment or individual using any certified automotive part. ◀

California Proposition 65 warning

California law requires us to issue the following warning:



Engine exhaust and a wide variety of automobile components and parts, including components found in the interior furnishings in a vehicle, contain or emit chemicals known to the State of California to cause cancer and birth defects and reproductive harm. In addition, certain fluids contained in vehicles and certain products of component wear contain or emit chemicals known to the State of California to cause cancer and birth defects or other reproductive harm.

Battery posts, terminals and related accessories contain lead and lead compounds. Wash your hands after handling.

Used engine oil contains chemicals that have caused cancer in laboratory animals. Always protect your skin by washing thoroughly with soap and water. ◀

Service and warranty

We recommend that you read this publication thoroughly.

Your BMW is covered by the following warranties:

- ▷ New Vehicle Limited Warranty
- ▷ Rust Perforation Limited Warranty
- ▷ Federal Emissions System Defect Warranty
- ▷ Federal Emissions Performance Warranty
- ▷ California Emission Control System Limited Warranty

Detailed information about these warranties is listed in the Service and Warranty Information Booklet for US models or in the Warranty and Service Guide Booklet for Canadian models.

Your vehicle has been specifically adapted and designed to meet the particular operating conditions and registration requirements in your country and continental region in order to deliver the full driving pleasure while the vehicle is operated under those conditions. If you wish to operate your vehicle in another country or region, you may be required to adapt your vehicle to meet different prevailing operating conditions and registration requirements. You should also be aware of any applicable warranty limitations or exclusions for such country or region. In such case, please contact Customer Relations for further information.

Maintenance

Maintain the vehicle regularly to sustain the road safety, operational reliability and the New Vehicle Limited Warranty.

Specifications for required maintenance measures:

- ▷ BMW Maintenance system
- ▷ Service and Warranty Information Booklet for US models
- ▷ Warranty and Service Guide Booklet for Canadian models

If the vehicle is not maintained according to these specifications, this could result in serious damage to the vehicle. Such damage is not covered by the BMW New Vehicle Limited Warranty.

Data memory

A variety of electronic components in your vehicle include data storage devices, which store technical information on the condition of your vehicle, events and errors, either temporarily or permanently. In general, this technical information documents the condition of a component, a module, a system or the surroundings:

- ▷ Operating conditions of system components, e.g., fill levels.
- ▷ Status messages regarding the vehicle and of its individual components, such as wheel rpm/vehicle speed, response delay, lateral acceleration.
- ▷ Malfunctions and defects in the major system components, such as the lights and brakes.
- ▷ Responses of the vehicle in special driving situations, such as the deployment of an airbag, the utilization of stability control systems.
- ▷ Environmental conditions, such as temperature.

These data are exclusively of a technical nature and are used for the detection and correction of errors, as well as the optimization of vehicle functions. Motion profiles of traveled routes can not be deduced from these data. If services are required, such as repair services, service processes, warranty claims and quality assurance, then this technical information can be read out by employees of service departments, including the manufacturer, from the event and error data storage devices by using special diagnostic equipment. There, if necessary, you will

receive further information. After remedying an error, the information in the error memory is deleted or progressively overwritten.

When using the vehicle, situations are conceivable in which this technical data, in conjunction with other information, such as accident reports, vehicle damage, witness statements, etc. - possibly with the assistance of an expert - could be traced to particular individuals.

Additional functions that are agreed upon contractually with the customer, such as vehicle tracking in case of emergency, permit the transmission of certain vehicle data from the vehicle.

Reporting safety defects

For US customers

The following only applies to vehicles owned and operated in the US.

If you believe that your vehicle has a defect which could cause a crash or could cause injury or death, you should immediately inform the National Highway Traffic Safety Administration, NHTSA, in addition to notifying BMW of North America, LLC, P.O. Box 1227, Westwood, New Jersey 07675-1227, Telephone 1-800-831-1117.

If NHTSA receives similar complaints, it may open an investigation, and if it finds that a safety defect exists in a group of vehicles, it may order a recall and remedy campaign. However, NHTSA cannot become involved in individual problems between you, your center, or BMW of North America, LLC.

To contact NHTSA, you may call the Vehicle Safety Hotline toll-free at 1-888-327-4236 (TTY: 1-800-424-9153); go to <http://www.safercar.gov>; or write to: Administrator, NHTSA, 400 Seventh Street, SW., Washington, DC 20590. You can also obtain other information about motor vehicle safety from <http://www.safercar.gov>

For Canadian customers

Canadian customers who wish to report a safety-related defect to Transport Canada, Defect Investigations and Recalls, may telephone the toll-free hotline 1-800-333-0510. You can also obtain other information about motor vehicle safety from <http://www.tc.gc.ca/roadsafety>



At a glance

This overview of buttons, switches and displays is intended to familiarize you with your vehicle's operating environment. The section will also assist you in becoming acquainted with the control concepts and options available for operating the various systems.

Dashboard









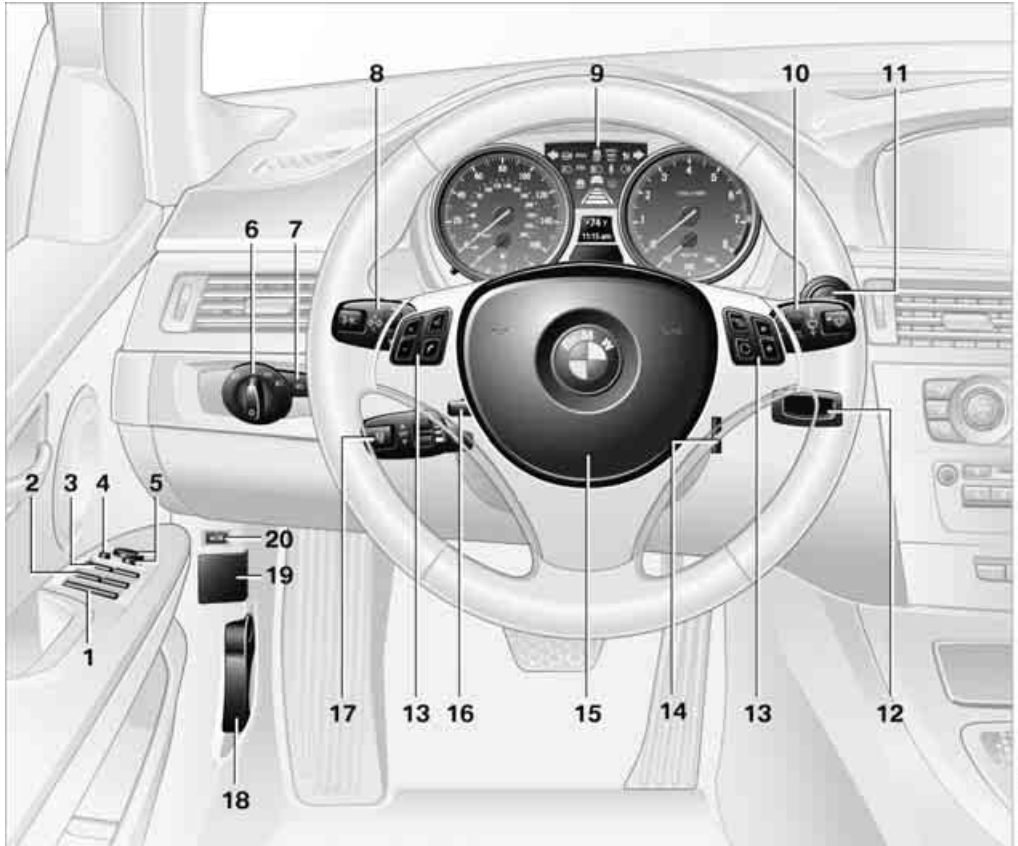





















Vehicle equipment

In this chapter, all production, country, and optional equipment that is offered in the model range is described. For this reason, descrip-

tions will be given of some equipment that may not be available in a vehicle, for example due to the special options or national-market version selected. This also applies to safety related functions and systems.

Around the steering wheel: controls and displays



- 1  Convertible: opening and closing windows jointly 41
- 2  Convertible: opening and closing rear windows 41
- 3  Opening and closing front windows 41
- 4 Exterior mirrors folding in and out 55
- 5 Adjusting exterior mirrors, automatic curb monitor 55
- 6  Parking lamps 110
-  Low beams 110
-  Automatic headlamp control 110
-  Adaptive Light Control 111
-  High-beam Assistant 112
- 7  Fog lamps 113
- 8  Turn signals 72
-  High beams, headlamp flasher 112
-  High-beam Assistant 112
-  Roadside parking lamps 112
-  Computer 85
-  Settings and information about the vehicle 87
- 9 Instrument cluster 14
- 10  Windshield wipers 72
-  Rain sensor 73
- 11  Switching the ignition on/off and starting/stopping the engine 62
- 12 Ignition lock 62
- 13 Buttons on the steering wheel
-  Telephone: accepting and ending a call; dialing the selected phone number; redialing if no phone number is selected
- Convertible: microphone on steering column
-  Volume
-  Activating/deactivating the voice activation system 27
- Convertible: microphone on steering column
-  Changing the radio station
-  Interrupting a traffic bulletin
-  Selecting a music track
-  Scrolling through the redial list
-  Next entertainment source
-  Recirculated air mode 117
- 14  Steering wheel heating 57
- 15 Horn, entire surface
- 16 Adjusting the steering wheel 56
- 17  Cruise control 76
-  Active Cruise Control 76
- 18 Releasing the hood 256
- 19 OBD socket 261
- 20 Opening the trunk lid 37

Instrument cluster



- 1 Speedometer
- 2 Indicator lamps for turn signals
- 3 Indicator and warning lamps [15](#)
- 4 Displays for Active Cruise Control [76](#)
- 5 Tachometer [84](#)
- 6 Engine oil temperature [84](#)
- 7 Display for
 - ▷ Clock [83](#)
 - ▷ Outside temperature [83](#)
 - ▷ Indicator and warning lamps [92](#)
- 8 Display for
 - ▷ Position of automatic transmission [65](#)
 - ▷ Gear indicator of 7-gear Sport automatic transmission with double clutch [67](#)
 - ▷ Computer [85](#)
 - ▷ Date of next scheduled service, and remaining distance to be driven [88](#)
 - ▷ Odometer and trip odometer [83](#)
 - ▷ High-beam Assistant [112](#)
 - ▷ Checking the oil level [256](#)
 - ▷ Settings and information [87](#)
 - ▷  There is a Check Control message [92](#)
- 9 Fuel gauge [84](#)
- 10 Resetting the trip odometer [83](#)

Indicator and warning lamps

The concept



Indicator and warning lamps can light up in a variety of combinations and colors.

Several of the lamps are checked for proper functioning and light up temporarily when the engine is started or the ignition is switched on.

Text messages

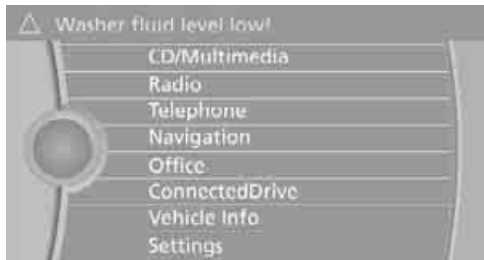

Text messages at the top edge of the Control Display describe the meanings of the indicator and warning lamps.

Supplementary text messages

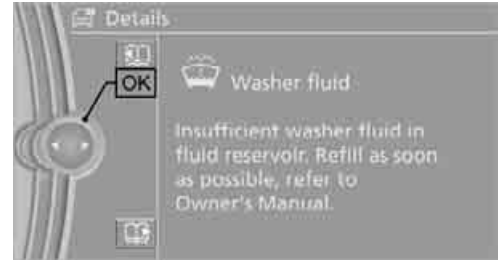







You can call up more information on the Control Display, e.g. on the cause of a malfunction and on how to respond, via Check Control, refer to page 92.

In urgent cases, this information will be shown as soon as the corresponding lamp comes on.

Indicator lamps without text messages

The following indicator lamps notify you that certain functions are active:





-  High beams/headlamp flasher [112](#)
-  Fog lamps [113](#)
-  Lamp flashes:
DSC or DTC is regulating the propulsive forces in order to maintain driving stability [98](#)
-  BRAKE Parking brake applied [64](#)
-  Canada: parking brake applied [64](#)
-  SERVICE ENGINE SOON Engine malfunction with adverse effect on emissions [261](#)
-  Canada: engine malfunction with adverse effect on emissions [261](#)











Around the center console: controls and displays



- 1 Control Display [20](#)
- 2 Hazard warning flashers
- 3 Driving stability control systems
 - ▷ Dynamic Stability Control DSC [97](#)
 - ▷ Dynamic Traction Control DTC [98](#)
- 4 Central locking system [36](#)

- 5 Automatic climate control

-  Air distribution to the windshield [116](#)
-  Air distribution to the upper body area [116](#)
-  Air distribution to the footwell [116](#)
-  AUTO Automatic air distribution and flow rate [116](#)
-  A/C Air conditioning [118](#)

-  Automatic recirculated air control
AUC and recirculated air mode [117](#)
-  Maximum cooling [116](#)
- ALL** ALL program [117](#)
-  Air volume [117](#)
-  Defrosting windows [118](#)
-  Rear window defroster [118](#)
-  Seat heating [53](#)
- 6** CD/DVD drive [178](#)
- 7** Changing
 - ▷ Radio station [169](#)
 - ▷ Track [178](#)
- 8**  Park Distance Control PDC [96](#)
 -  Coupe:
Roller sunblinds [124](#)
 -  Coupe:
Hill Descent Control HDC [99](#)
- 9** Controller [20](#)
Can be turned, pressed, or moved in four directions
- 10** Buttons on the controller [20](#)
Selecting menus directly
- 11**  Convertible:
Opening and closing retractable hardtop [44](#)
- 12** Programmable memory keys [25](#)
- 13** Switching entertainment audio sources on/
off and adjusting volume [166](#)
- 14** Ejecting a CD/DVD [178](#)

Around the roofliner

Coupe

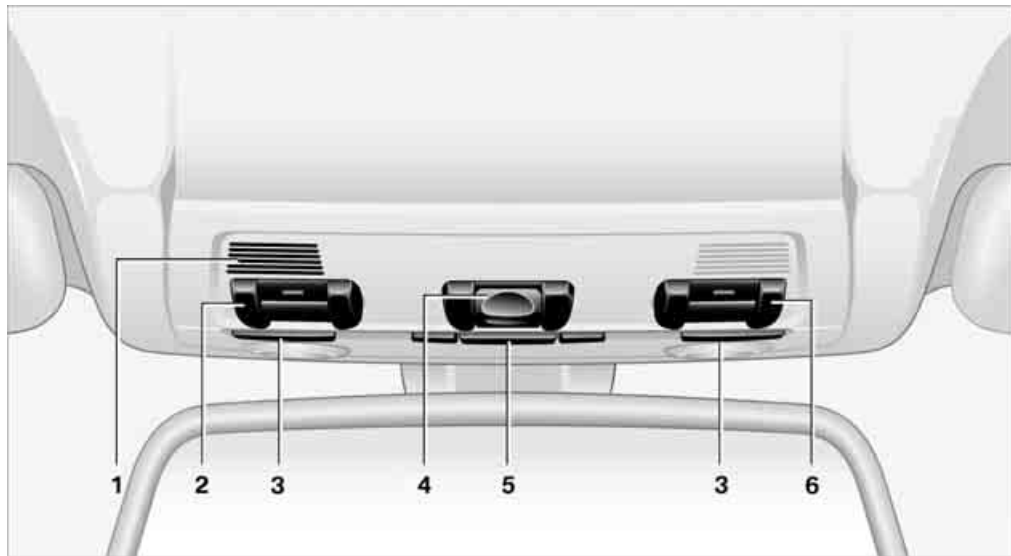

1 Microphone for voice activation system and for telephone in hands-free mode

2  SOS: sending an Emergency Request [272](#)

3  Reading lamps [114](#)





4  Glass sunroof [43](#)

5  Interior lamps [114](#)

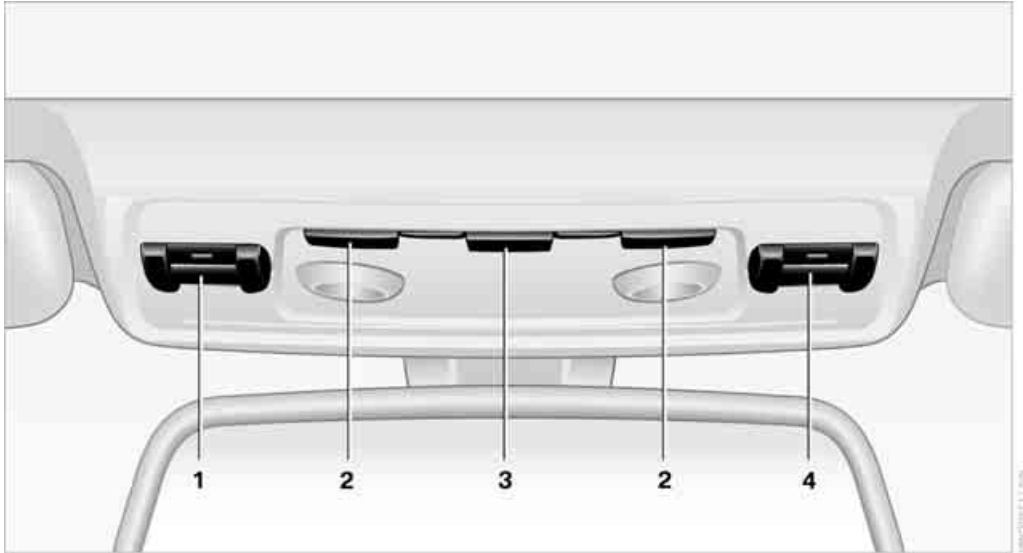
6  Passenger airbag status lamp [108](#)

Convertible



- 1  SOS: sending an Emergency Request [272](#)
- 2  Reading lamps [114](#)
- 3  Interior lamps [114](#)
- 4  Passenger airbag status lamp [108](#)

iDrive

Vehicle equipment

In this chapter, all production, country, and optional equipment that is offered in the model range is described. For this reason, descriptions will be given of some equipment that may not be available in a vehicle, for example due to the special options or national-market version selected. This also applies to safety related functions and systems.

Controls at a glance

Controls

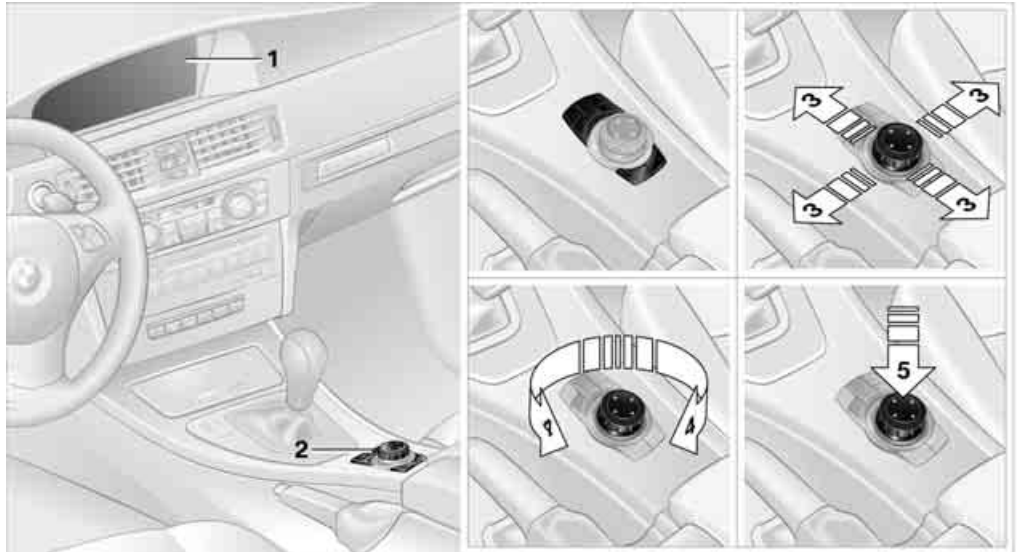

- 1 Control Display
- 2 Controller with buttons
You can use the buttons to open the menus

The concept

iDrive integrates the functions of a large number of switches. This allows these functions to be operated from a single central position.

 Make entries only when traffic and road conditions permit; otherwise, you may endanger vehicle occupants and other road users by being distracted. ◀

directly. The controller can be used to select the menu items and create settings.

- ▷ Move in four directions, arrows **3**
- ▷ Turn, arrow **4**
- ▷ Push, arrow **5**

Control Display

Notes

- ▷ Follow care instructions when cleaning the Control Display.
- ▷ Do not store items in the region in front of the Control Display; doing so may damage the Control Display.

Switching off

1.  Press the button.
2. "Switch off control display"

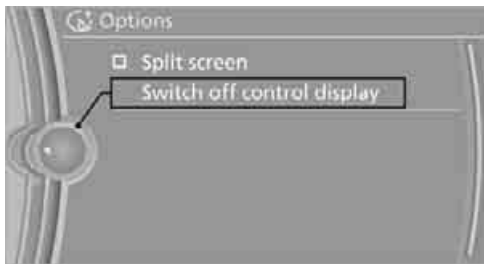

Switching on

Press the controller to switch on.

Buttons on the controller

Symbol	Function
MENU	Open the main menu
RADIO	Open the Radio menu
MEDIA	Open the CD/Multimedia menu
NAV	Start navigation in map view
TEL	Open the Telephone menu
BACK	Show previous panel
OPTION	Open the Options menu

Operating principle

With the ignition at radio readiness or beyond, refer to page 62, the following message is displayed on the Control Display:

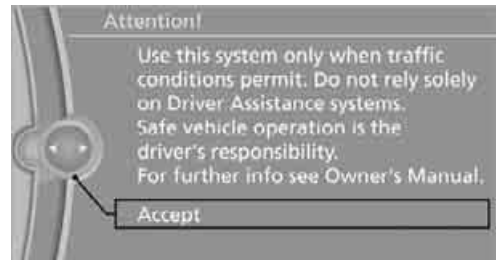

To hide the message:

Press the controller.

The main menu is displayed.

The message is automatically hidden after approx. 10 seconds.

Opening the main menu

1.  Press the button.

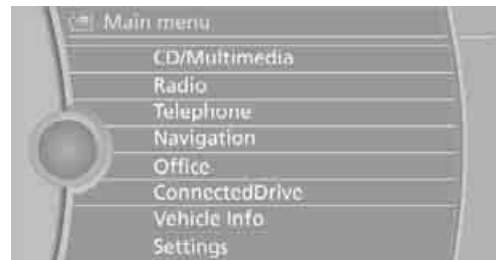

The main menu is displayed.

All iDrive functions can be called up via the main menu.

Selecting a menu item

The menu items shown in white can be selected.

1. Turn the controller until the desired menu item is highlighted.

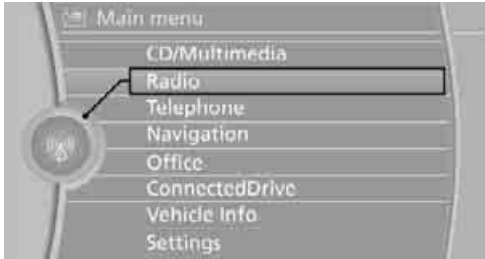

2. Press the controller.

Menu items in the Owner's Manual

In the Owner's Manual, the menu items that should be selected are depicted in quotation marks, e.g. "Settings".

Changing between panels

After a menu item is selected, e.g. "Radio", a new panel is displayed. Panels can overlap.

- ▷ Move the controller to the left.

The current panel is closed and the previous panel is displayed. Pressing the BACK button reopens the previous panel. This does not close the current panel.
- ▷ Move the controller to the right.

A new panel is opened and laid over it.

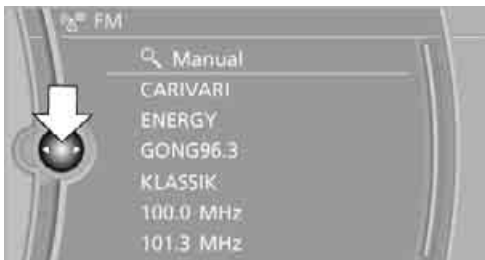

White arrows pointing to the left or right indicate that additional panels can be opened.

View of an opened menu

When you open a menu, generally the panel last selected in this menu is displayed. To display the first panel of the menu:

- ▷ Move the controller to the left repeatedly until the first panel is displayed.
- ▷ Press the menu's button twice on the controller.

Open the Options menu



Press the button.

The "Options" menu is displayed.



Another possibility: move the controller to the right repeatedly until the "Options" menu appears.

Options menu

The "Options" menu is composed of different areas:

- ▷ Screen settings, e.g. "Split screen".

The region remains unchanged.
- ▷ Control options for the selected main menu, e.g. "Radio".
- ▷ Other control options for the selected menu, e.g. "Store station".

Adjusting settings

1. Select a field.
2. Turn the controller until the desired setting is displayed.

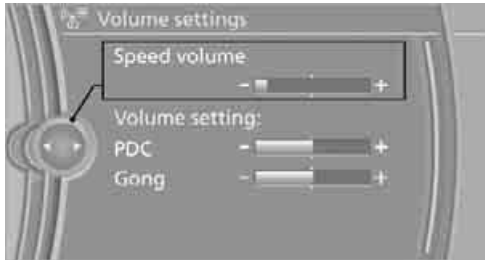

3. Press the controller.

Activating/deactivating functions

Some menu items are preceded by a check box. It indicates whether the function is activated or deactivated. Selecting the menu item activates or deactivates the function.

- The function is activated.
- The function is deactivated.

Example: setting the clock

1.  Press the button.
The main menu is displayed.
2. Turn the controller until "Settings" is highlighted, and then press the controller.

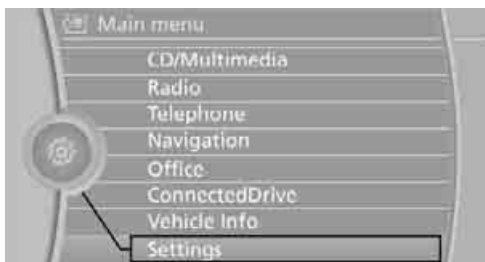

3. If necessary, move the controller to the left to display "Time/Date".

4. Turn the controller until "Time/Date" is highlighted, and then press the controller.



5. Turn the controller until "Time:" is highlighted, and then press the controller.

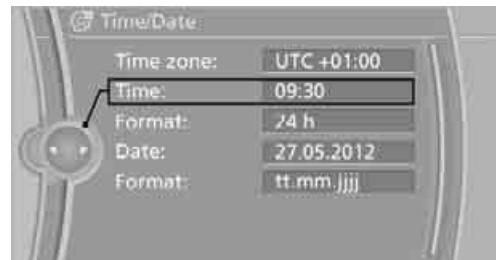

6. Turn the controller to set the hours and press the controller.
7. Turn the controller to set the minutes and press the controller.

Status information

Status box



The status box at the top right displays the following information:

- ▷ Time
- ▷ Current entertainment source
- ▷ Sound output ON/OFF
- ▷ Mobile phone network with strongest reception
- ▷ Telephone status
- ▷ Traffic reports reception











Status box symbols

The symbols are divided into separate groups.







Radio symbols

Symbol	Meaning
	Traffic bulletins switched on
	HD radio switched on
	Satellite radio switched on



Telephone symbols

Symbol	Meaning
	Incoming or outgoing call
	Missed call
	Reception strength of mobile phone network symbol flashing: Network search
	No mobile phone network available
	Bluetooth switched on
	Roaming active
	Receiving text message, email
	Checking SIM card
	SIM card blocked
	SIM card missing
	Entering PIN

Entertainment symbols

Symbol	Meaning
	CD/DVD player
	Music collection
	Gracenote® database
	AUX-IN port
	USB audio interface
	Music interface for smartphones

Other

Symbol	Meaning
	Voice instructions are switched off
	Querying current vehicle position

With the Professional navigation system: Split screen

General information

Additional information, e.g. from the computer, can be displayed on the right side of the split screen.

This information remains visible on the split screen even when you change to another menu.

Switching the split screen on and off

-  Press the button.
- "Split screen"

Selecting display

-  Press the button.
- "Split screen"
- Move the controller until the split screen is selected.
- Press the controller or select "Split screen content".
- Select the desired menu item.

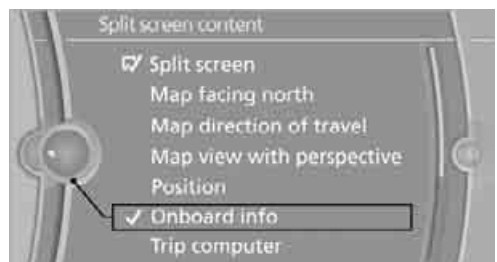



Programmable memory keys

General information

iDrive functions can be stored on the programmable memory keys and called up directly, e.g. radio stations, navigation destinations, phone numbers and entry points into the menu.

The settings are stored for the remote control currently in use.

Storing functions

1. Highlight the function via the iDrive.
2. Press the desired button  ...  for longer than two seconds.

Executing a function

 ...  Press the button.

The function is executed immediately. This means, for example, that the number is dialed when a phone number is selected.

Displaying memory key assignments

Touch the button with a finger. Do not wear gloves or use objects.



The key assignment is displayed at the top edge of the screen.



- ▷ Displaying brief information: Press the button.
- ▷ Displaying detailed information: Press and hold the button



Entering letters and numbers

1. Turn the controller: select the letters or numbers.
2. Select additional letters or numbers if needed.
3. "OK": confirm entry.

Symbol	Function
	Press the controller: delete one letter or number
	Press the controller for an extended period: delete all letters or numbers
	Enter a blank space



Switching between letters and numbers

Depending on the menu, you can switch between entering letters and numbers:

Symbol	Function
	Entering letters
	Entering numbers

Switching between uppercase and lowercase letters

Depending on the menu, you can switch between entering uppercase letters and lowercase letters:

Symbol	Function
 abc	Move the controller toward the front: to switch from uppercase letters to lowercase letters
 ABC	Move the controller toward the front: to switch from lowercase letters to uppercase letters

Entry comparison

Entry of names and addresses: the selection is narrowed down every time a letter is entered and letters may be added automatically.

The entries are continuously compared to the data stored in the vehicle.

- ▷ During entry, only letters for which there are data are offered.
- ▷ Destination search: town/city names can be entered with the spelling used in any of the languages available on the Control Display.

Voice activation system

Vehicle equipment

In this chapter, all production, country, and optional equipment that is offered in the model range is described. For this reason, descriptions will be given of some equipment that may not be available in a vehicle, for example due to the special options or national-market version selected. This also applies to safety related functions and systems.

The concept

- ▷ The voice activation system can be used to control most functions by spoken commands.
- ▷ Functions that can only be used when the vehicle is stopped cannot be operated using the voice activation system.
- ▷ The system includes a special microphone on the driver's side.
- ▷ In the Owner's Manual, ›...‹ indicates commands for the voice activation system.
- ▷ In the Owner's Manual, ››...‹‹ indicates the answers from the voice activation system.

Prerequisite

On the Control Display, set a language that is also supported by the voice activation system to permit identification of the commands to be spoken.

Setting the language, refer to page 95.

Saying commands

Activating voice activation system

1. Press the  button on the steering wheel.
2. Wait for the acoustic signal.
3. Say the command.

 This symbol on the Control Display and an acoustic signal notify you that the voice activation system is activated.

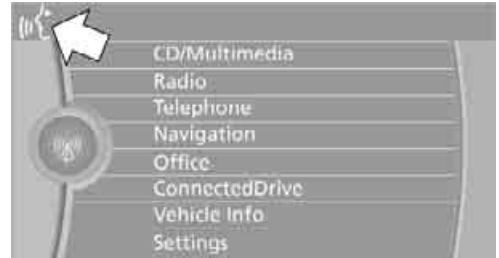

If no additional commands are possible, continue by operating the function via iDrive.

Finishing voice input

Press the  button on the steering wheel or

 ›Cancel‹

Possible commands

Most menu items on the Control Display can be spoken as commands.

The available commands depend on which menu is currently selected on the Control Display.

There are short commands for functions of the main menu.

Some list entries such as phone book entries can also be selected using the voice activation system. Make sure to say list entries the same way as they appear in the respective list.

Having the possible commands read aloud

To have the available commands read aloud:

 ›Voice commands‹

For example, if the "Settings" menu is displayed, the commands relating to settings are read aloud.

Performing functions using short commands

Functions from the main menu can be performed directly by means of short commands, essentially regardless of which menu item is selected, e.g. ›Vehicle status‹.

List of short command of the voice activation system, refer to page 283.

Help dialog for voice activation system

Accessing help:



 ›Help‹

Other commands for the help dialog:

- ▷ ›Help with examples‹ : information about the current control options and the most important commands relating to them are read aloud.
- ▷ ›Help with voice activation‹ : information about the principle operation of the voice activation system is read aloud.



Example: playing back a CD

Via the main menu

1. If necessary, switch on entertainment audio output.
2. Press the  button on the steering wheel.
-  3. ›C D and multimedia‹
The system plays the last media played.
4. ›C D‹
5. ›C D drive‹
The CD is played.
6. Press the  button on the steering wheel again in order to select the particular track.
7. ›Track ...‹ e.g. CD track 4.

Via short commands

The CD playback can also be started via a short command.

1. If necessary, switch on entertainment audio output.
2. Press the  button on the steering wheel.
-  3. ›C D drive Track ...‹ e.g. CD track 4.

Setting the voice dialog

You can set whether the system uses the standard dialog or a short version.

In the short version of the voice dialog, the responses from the system are given in abbreviated form.

On the Control Display:

1. "Settings"
2. "Language/Units"
3. "Speech mode:"
4. Select a setting.

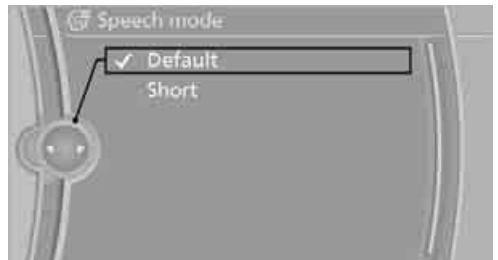

Adjusting volume

Turn the volume knob during the spoken instruction to select the desired volume.

- ▷ The volume remains the same, even if the volume of other audio sources is changed.
- ▷ The volume is stored for the remote control currently in use.

Notes on Emergency Requests

Do not use the voice activation system to initiate an Emergency Request. In stressful situations, the voice and vocal pitch can change. This can unnecessarily delay the establishment of a telephone connection.

Instead, use the SOS button, refer to page 272, in the vicinity of the interior rearview mirror.

Ambient conditions

- ▷ Say the commands, numbers and letters smoothly and with normal volume, emphasis and speed.
- ▷ Always speak the commands in the language of the voice activation system.
- ▷ When selecting a radio station, use the standard pronunciation of the station name:
›Station ...‹ e.g. National Public Radio
- ▷ Keep the doors, windows, glass roof/panoramic glass roof closed to prevent interference from ambient noise.
- ▷ Avoid ambient noise in the vehicle while speaking.



Controls

This chapter is intended to provide you with information for complete control of your vehicle. All features and accessories that are useful for driving and your safety, comfort and convenience, are described here.

Opening and closing

Vehicle equipment

In this chapter, all production, country, and optional equipment that is offered in the model range is described. For this reason, descriptions will be given of some equipment that may not be available in a vehicle, for example due to the special options or national-market version selected. This also applies to safety related functions and systems.

Remote control



Each remote control contains a rechargeable battery that is automatically recharged when it is in the ignition lock while the car is being driven. Use each remote control at least twice a year for longer road trips in order to maintain the batteries' charge status. In cars with Comfort Access, the remote control contains a replaceable battery, refer to page 41.

The settings called up and implemented when the car is unlocked depend on which remote control is used to unlock the car, refer to Personal Profile, next column.

In addition, information about service requirements is stored in the remote control, refer to Service data in the remote control, page 260.

Integrated key



Press button 1 to release the key.

The integrated key fits the following locks:

- ▷ Glove compartment, refer to page 124
- ▷ Driver's door, refer to page 36

New remote controls

Your BMW center can supply new remote controls with integrated keys as additional units or as replacements in the event of loss.

Personal Profile

The concept

You can set many of your BMW's functions to suit your personal needs and preferences. Without any action on your part, Personal Profile ensures that most of these settings are stored for the remote control currently in use. When you unlock the car, the remote control used for the purpose is recognized and the settings stored for it are called up and implemented.

This means that your personal settings will be activated for you, even if in the meantime your car was used by someone else with another remote control and the corresponding settings. The individual settings are stored for a maximum of four remote controls. They are stored for two remote controls if Comfort Access is in use.

Personal Profile settings

For more information on specific settings, refer to the specified pages.

- ▷ Assignment of programmable memory keys, refer to page [25](#)
- ▷ Response of the central locking system when the car is unlocked, refer to page [34](#)
- ▷ Automatic locking of the vehicle, refer to page [36](#)
- ▷ Automatic call-up of the driver's seat position, refer to page [53](#)
- ▷ Triple turn signal activation, refer to page [72](#)
- ▷ Settings for the display on the Control Display and in the instrument cluster:
 - ▷ 12h/24h format of the clock, refer to page [91](#)
 - ▷ Date format, refer to page [92](#)
 - ▷ Brightness of the Control Display, refer to page [95](#)
 - ▷ Language on the Control Display, refer to page [95](#)
 - ▷ Units of measure, refer to page [88](#)
- ▷ Show visual warning for Park Distance Control PDC, refer to page [97](#)
- ▷ Light settings:
 - ▷ Welcome lamps, refer to page [111](#)
 - ▷ Pathway lighting, refer to page [111](#)
 - ▷ Daytime running lights, refer to page [111](#)
 - ▷ High-beam Assistant, refer to page [112](#)
- ▷ Automatic climate control: activating/deactivating AUTO program, air conditioning and automatic recirculated air control, setting temperature, air volume and distribution, refer to page [116](#) ff
- ▷ Entertainment:
 - ▷ Setting tone controls, refer to page [167](#)
 - ▷ Speed-dependent volume control, refer to page [168](#)

Central locking system

The concept

The central locking system functions when the driver's door is closed.

The system simultaneously engages and releases the locks on the following:

- ▷ Doors
- ▷ Trunk lid
- ▷ Fuel filler flap
- ▷ Convertible: glove compartment

Operating from outside

- ▷ Via the remote control
- ▷ Using the door lock
- ▷ In cars with Comfort Access, via the handles on the driver's door and the front passenger door

At the same time as locking and unlocking via the remote control:

- ▷ Welcome lights, the interior light, and the courtesy lighting are switched on and off.
- ▷ Alarm system, refer to page [38](#), is armed or disarmed.

Operating from inside

By means of the button for central locking, refer to page [36](#).

In the event of a sufficiently severe accident, the central locking system unlocks automatically. In addition, the hazard warning flashers and interior lamps come on.

Opening and closing: Using the remote control



Persons or animals in a parked vehicle could lock the doors from the inside. You should therefore take the remote control with you when you leave the vehicle so that the latter can be opened from outside. ◀

 **Convertible:** to operate the retractable hardtop with the remote control, the doors and trunk lid must be closed and the trunk partition must be folded down and engaged on both sides. Refer also to page 44. ◀

Unlocking

Press the  button.

The interior lamps, the courtesy lighting of the doors, and the welcome lamps come on.

Setting unlocking characteristics

You can set whether only the driver's door or the entire vehicle is to be unlocked when the button is pressed for the first time.

1. "Settings"
2. "Door locks"
3. "Unlock button"

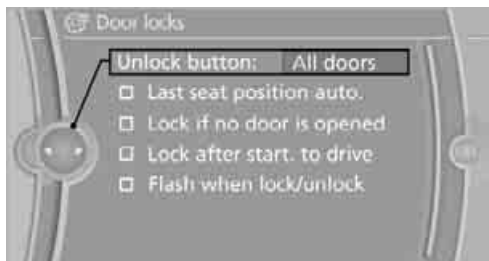

4. Select a menu item:
 - ▶ "All doors"

Press the  button once to unlock the entire vehicle.
 - ▶ "Driver's door only"

Pressing the  button once unlocks the driver's door and fuel filler flap. Press the button twice to unlock the entire vehicle.
5. Press the controller.

Coupe: convenient opening

Press and hold the  button.

The windows and the glass roof are opened.

Convertible: convenient opening

When you are close to the vehicle, the remote control for Comfort Access can be used to open the retractable hardtop.

Hold the  button down.

The windows and the retractable hardtop are opened if the doors are closed.

If you continue pressing the  button, the windows move up.

 Watch during the opening process to ensure that no one is injured. Releasing the button interrupts the opening process. ◀

Locking

Press the  LOCK button.

 Do not lock the vehicle from the outside if there is any person inside, because the vehicle cannot be unlocked from inside without special knowledge. ◀

Convertible: convenient closing

When you are close to the vehicle, the remote control for Comfort Access can be used to close the retractable hardtop and the windows.

Press and hold the  LOCK button.

The retractable hardtop and the windows are closed.

 Watch during the closing process to ensure that no one is injured. Releasing the button interrupts the closing process. ◀

Switching on interior lamps

While the car is locked:

Press the  LOCK button.

You can also use this function to locate your vehicle in parking garages etc.

Unlocking the trunk lid

Press the  button for about 1 second and then release it.

The trunk lid opens a short distance, regardless of whether it was locked or unlocked.



The trunk lid swings back and up when opened. Ensure that there is sufficient clearance. To avoid locking yourself out by accident, do not place the remote control in the trunk. A previously locked trunk lid is locked again after closing.

Before and after each trip, check that the trunk lid has not been inadvertently unlocked. ◀

Convertible: convenient loading

When you are close to the vehicle, the remote control for Comfort Access can be used to partially raise the open hardtop for more convenient loading of the trunk.

1. Briefly press the button and, within one second, press again and hold until the retractable hardtop stops in an intermediate position. The trunk lid opens slightly.
2. Open the trunk lid, press the trunk partition upward and stow the cargo in the trunk.
3. Press down the trunk partition until it engages on both sides and close the trunk lid.
4. Press the button for a longer period to fold the retractable hardtop back in.

Confirmation signals

You can activate or deactivate the confirmation signals.

1. "Settings"
2. "Door locks"
3. "Flash when lock/unlock"

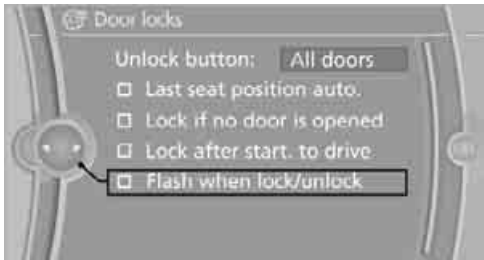

4. Press the controller.

Calling up the driver's seat position

The driver's seat position last set is stored for the remote control currently in use.

You can select whether or not the seat is reset to that position automatically.



When this Personal Profile function is used, first make sure that the footwell behind the driver's seat is free of obstacles. Failure to do so could cause injury to persons or damage to objects as a result of a rearward movement of the seat. ◀

The adjusting procedure is halted immediately when you touch a seat adjustment switch or one of the memory buttons.

Selecting automatic call-up

1. "Settings"
2. "Door locks"
3. "Last seat position auto."



The setting is stored for the remote control currently in use.

Malfunctions

The remote control may malfunction due to local radio waves. If this occurs, unlock and lock the car at the door lock with the integrated key.

Convertible: if hardtop movement via the remote control is interrupted briefly, the movement will be completed more quickly if you keep the corresponding button pressed continuously.

If the car can no longer be locked with a remote control, the battery in the remote control is discharged. Use the remote control on an

extended trip to recharge the battery, refer to page 32. The remote control for Comfort Access contains a battery that may have to be changed, refer to page 41.

For US owners only

The transmitter and receiver units comply with part 15 of the FCC/Federal Communications Commission regulations. Operation is governed by the following:

FCC ID:

LX8766S

LX8766E

LX8CAS

Compliance statement:

This device complies with part 15 of the FCC Rules. Operation is subject to the following two conditions:

- ▷ This device must not cause harmful interference, and
- ▷ this device must accept any interference received, including interference that may cause undesired operation.



Any unauthorized modifications or changes to these devices could void the user's authority to operate this equipment. ◀

Opening and closing: Using the door lock

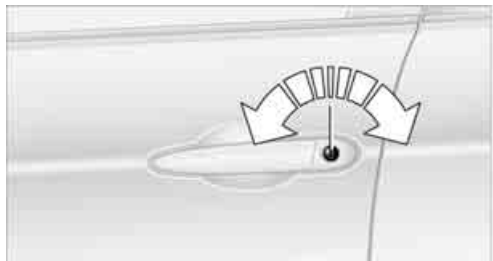

Do not lock the vehicle from the outside if there is any person inside, because the vehicle cannot be unlocked from inside without special knowledge. ◀

With Comfort Access, you can set how the vehicle is unlocked, refer to page 34.

Manual operation

In the event of an electrical malfunction, you can lock and unlock the driver's door by turning the integrated key to the corresponding limit positions in the door lock.

Opening and closing: From inside



This button serves to unlock or lock doors and the trunk lid when the front doors are unlocked or locked, but does not activate the anti-theft system. Depending on the equipment package, the fuel filler flap can be unlocked as needed.

Automatic locking

You can also set the situations in which the car locks:

1. "Settings"
2. "Door locks"
3. Select the desired function:
 - ▷ "Lock if no door is opened"
The central locking system automatically locks the vehicle after a short time if no door has been opened.
 - ▷ "Lock after start. to drive"
The central locking system locks the vehicle as soon as you begin to drive.



The setting is stored for the remote control currently in use.

Unlocking and opening doors

- ▶ Either unlock the doors together using the button for the central locking system and then pull the door handle above the armrest or
- ▶ pull on the door handle of each door twice: The first time unlocks the door, the second time opens it.

Locking

- ▶ Use the central locking button to lock all of the doors simultaneously, or
- ▶ press down the safety lock button of a door. To prevent you from being locked out, the open driver's door cannot be locked using the lock button.



Persons or animals in a parked vehicle could lock the doors from the inside. You should therefore take the remote control with you when you leave the vehicle so that the latter can be opened from outside. ◀

Trunk lid



In order to avoid damage, make sure there is sufficient clearance before opening the trunk lid. ◀

Opening from inside



Press the button: the trunk lid opens unless it has been locked.

Opening from outside



Press the button, see arrow, or the  button on the remote control for a longer period. The trunk lid will open slightly. It can now be swung upwards.

Coupe: locking or unlocking separately

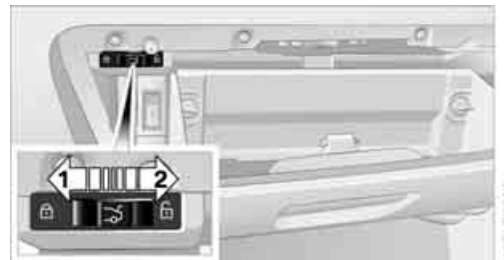

The switch is located in the glove compartment.

- 1 Locking the trunk lid
- 2 Unlocking the trunk lid

Locking separately

Push the switch in the direction of arrow 1. The trunk lid is locked and cannot be unlocked using the central locking system.

If you give the remote control without the integrated key to someone else while the glove compartment is locked, the trunk lid cannot be opened. This is an advantage when valet parking, for example. Locking the glove compartment, refer to page 124.

Unlocking separately

Push the switch in the direction of arrow 2.

Emergency release



Pull the lever in the trunk. The trunk lid is unlocked.

Closing

The handle recesses on the interior trim of the trunk lid make it easier to pull down.

 Make sure that the closing path of the trunk lid is clear; otherwise, injuries may result. ◀

Coupe



Convertible



To close the trunk lid, press it down lightly. The lid is closed automatically. ◀



Alarm system

The concept

The vehicle alarm system responds:

- ▷ When a door, the hood or the trunk lid is opened
- ▷ To movements inside the vehicle: Interior motion sensor, refer to page 39
- ▷ When the car's inclination changes, for instance if an attempt is made to jack it up and steal the wheels or to raise it prior to towing away
- ▷ When there has been an interruption of power supply from the battery

The alarm system signals unauthorized entry attempts for a short time by means of:

- ▷ An acoustic alarm
- ▷ Switching on the hazard warning flashers
- ▷ Flashing the high beams

Arming and disarming

General information

When you lock or unlock the vehicle, either with the remote control or at the door lock, the alarm system is armed or disarmed at the same time.

Door lock with armed alarm system

In some national-market versions, unlocking via the door lock triggers the alarm.

To switch off this alarm, unlock the vehicle with the remote control or switch on the ignition.

Trunk lid with the alarm system armed

The trunk lid can be opened via the remote control even when the alarm system is armed.

Press the  button on the remote control for approx. 1 second.

The trunk lid is locked and monitored again as soon as it is closed.

Panic mode

You can trigger the alarm system if you find yourself in a dangerous situation:

Press the  button for at least three seconds.

To switch off the alarm: press any button.

Switching off an alarm

- ▷ Unlock the car with the remote control, refer to page 34.
- ▷ Insert the remote control all the way into the ignition lock.

Indicator lamp on inside mirror



- ▷ The indicator lamp flashes continuously: The system is armed.
- ▷ The indicator lamp flashes after locking: The doors, hood, or trunk lid are not properly closed, the remaining components are secured.

Then the indicator lamp flashes continuously after approx. 10 seconds. The interior motion sensor and tilt sensor are not active.

- ▷ The indicator lamp goes out after unlocking: The vehicle has not been tampered with.
- ▷ If the indicator lamp flashes after unlocking until the remote control is inserted in the ignition, but for no longer than approx. 5 minutes: The vehicle has been tampered with.

Tilt alarm sensor

The tilt of the vehicle is monitored. The alarm system reacts, e.g. to attempts to steal a wheel or tow the vehicle.

Interior motion sensor

Coupe

For proper function, the windows and glass sunroof must be closed.

Convertible

The interior of the car is monitored up to the height of the seat cushions. Thus the alarm system is activated together with the interior motion sensor even if the hardtop is open. The alarm can be triggered unintentionally by falling objects such as leaves, refer to Avoiding unintentional alarms.

Avoiding unintentional alarms

The tilt sensor and interior motion sensor can be deactivated together, for example in the following situations:

- ▷ In car washes
- ▷ In stacking garages
- ▷ During transport on car-carrying trains, boats/ships or on a trailer
- ▷ When leaving animals in the vehicle

Switching off tilt alarm sensor and interior motion sensor

Once the vehicle is locked, press the **LOCK** button on the remote control again within approx. 10 seconds.

The indicator lamp lights up briefly and then flashes continuously. The tilt alarm sensor and the interior motion sensor are switched off until the next time the vehicle is unlocked and subsequently locked again.

Comfort Access

The concept

It is possible to access the vehicle without actuating the remote control. It is sufficient to have the remote control with you, for example in your jacket pocket. The vehicle automatically detects the remote control in the vicinity or in the passenger compartment.

Comfort Access supports the following functions:

- ▷ Unlocking/locking the vehicle
- ▷ Convenient closing
- ▷ Unlocking the trunk lid separately
- ▷ Engine starting

Functional requirement

- ▷ There are no external sources of interference in the vicinity.
- ▷ The remote control must be outside the vehicle to lock it.
- ▷ The next unlocking and locking cycle is not possible until after approx. 2 seconds.
- ▷ It is only possible to start the engine if the remote control is inside the vehicle.

Comparison to the standard remote control

The above functions can be controlled by pressing the remote control buttons or by using Comfort Access.



If you notice a brief delay while opening or closing windows, the glass roof or retractable hardtop, the system is checking whether a remote control is inside the vehicle. Please repeat the opening or closing procedure, if necessary. ◀

Unlocking

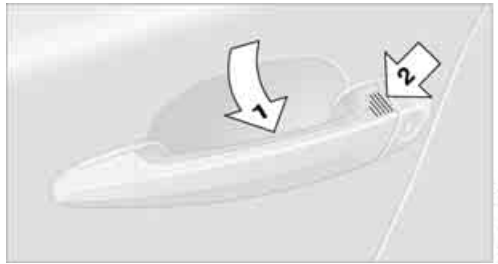

Grasp the handle on the driver's or front passenger door completely, arrow **1**. This corresponds to pressing the **UNLOCK** button.

Locking

Touch the surface on the door handle, arrow **2**, with your finger for approx. 1 second. This corresponds to pressing the **LOCK** button.



To preserve the battery, please make sure that the ignition and all electrical consumers are switched off before locking the vehicle. ◀

Coupe: convenient closing

Keep pressing the surface, arrow **2**, with your finger.

Convertible: window and convertible top operation

With the ignition at radio readiness or beyond, you can open and close the windows and the convertible top when a remote control is located inside the vehicle.

Unlocking the trunk lid separately

Press the button on the outside of the trunk lid. This corresponds to pressing the  button.

 If the vehicle detects that a remote control has been accidentally left inside the locked vehicle's trunk after the trunk lid is closed, the lid will reopen. The hazard warning flashers flash and a signal sounds. ◀

Switching on radio readiness

Pressing the Start/Stop button switches on radio readiness.

Do not depress the brake or the clutch; otherwise, the engine will start immediately.

Starting the engine

The engine can be started or the ignition can be switched on when a remote control is inside the vehicle. It is not necessary to insert a remote control into the ignition lock, refer to page 62.

Switching off the engine in cars with automatic transmission

The engine can only be switched off when the selector lever is in position P, refer to page 64. To switch the engine off when the selector lever is in position N, the remote control must be in the ignition lock.

Malfunction

Local radio waves can interfere with the function of Comfort Access, for example when a mobile phone is in the immediate vicinity of the remote control or by when a mobile phone is being charged in the vehicle.

If this happens, open or close the vehicle via the buttons on the remote control or using the integrated key. To start the engine afterward, insert the remote control into the ignition lock.

Warning lamps

 The warning lamp in the instrument cluster lights up when you attempt to start the engine: the engine cannot be started. The remote control is not inside the vehicle or is malfunctioning.

Take the remote control with you inside the vehicle or have it checked. If necessary, insert another remote control into the ignition lock.



The warning lamp in the instrument cluster lights up while the engine is running: the remote control is no longer inside the vehicle. After the engine is switched off, the engine can only be restarted within approx. 10 seconds.



The indicator lamp in the instrument cluster lights up and a message appears on the Control Display: replace the battery in the remote control.

Replacing the battery

The remote control for Comfort Access contains a battery that will need to be replaced from time to time.

1. Take the integrated key out of the remote control, refer to page 32.



2. Remove the cover.
3. Insert the new battery with the plus side facing up.
4. Press the cover on to close.



- Dispose of the old battery at a recycling center or at your BMW center. ◀

Windows



To prevent injuries, watch the windows while closing them.

Take the remote control with you when you leave the car; otherwise, children could operate the electric windows and possibly injure themselves. ◀

Coupe: opening, closing

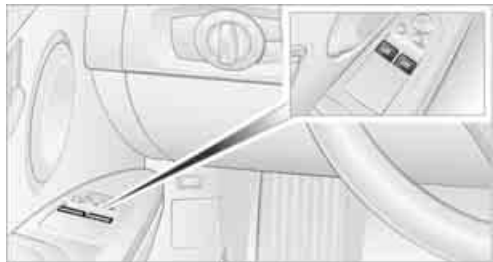

- ▷ Press the switch to the resistance point: The window opens as long as you press the switch.
- ▷ Press the switch beyond the resistance point: The window opens automatically. Press the switch again to stop the opening movement.

You can close the windows in the same manner by pulling the switch.

Convertible: opening, closing

Individually



- ▷ Press the switch to the resistance point: The window opens as long as you press the switch.
- ▷ Press the switch beyond the resistance point: The window opens automatically. Press the switch again to stop the opening movement.

You can close the windows in the same manner by pulling the switch. The rear windows do not close automatically.

Jointly

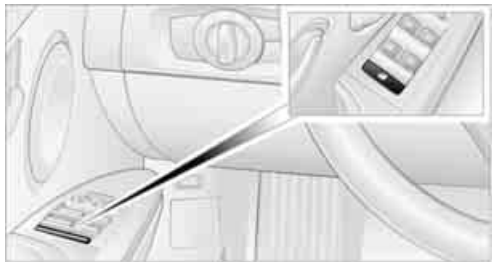

- ▷ Press the switch to the resistance point: All windows open as long as you press the switch.
- ▷ Press the switch beyond the resistance point: All windows open automatically. Press the switch again to stop the opening movement.
- ▷ Pull the switch: All windows close as long as you pull the switch.

After switching off the ignition

When the remote control is removed or the ignition is switched off, you can still operate the windows for approx. 1 minute as long as no door is opened.

Convenient opening and closing

For information on Convenient opening and closing via the remote control, refer to page 33. For information on Convenient closing with Comfort Access, refer to locking on page 34.

Pinch protection system

If the closing force exceeds a specific value as a window closes, the closing action is interrupted and the window reopens slightly.



Despite the pinch protection system check and clear the window's travel path prior to closing it; otherwise, the safety system might fail to detect certain kinds of obstructions, such as thin objects, and the window would continue closing.

Do not install any accessories that might interfere with window movement. Otherwise, the pinch protection system could be impaired. Convertible: the rear windows are not equipped with pinch protection. Therefore, watch them closely when closing to avoid personal injury. ◀

Closing without pinch protection

If there is an external danger, or if ice on the windows, etc., prevents you from closing the windows normally, proceed as follows:

1. Pull the switch past the resistance point and hold it there. Pinch protection is limited and the window reopens slightly if the closing force exceeds a certain value.
2. Pull the switch again past the resistance point within approx. 4 seconds and hold it there. The window closes without pinch protection.

Coupe: glass roof, electric

 To prevent injuries, watch the glass roof while closing it.

Take the remote control with you when you leave the car; otherwise, children could operate the roof and possibly injure themselves. ◀



Tilting

Press the switch.

- ▷ The closed glass roof is tilted and the sliding visor opens slightly.

Opening, closing

- ▷ Push the switch rearward to the resistance point:
The glass roof and the sliding visor open together as long as you hold the switch in this position.
- ▷ Push the switch rearward past the resistance point:
The glass roof and the sliding visor open automatically. Briefly press the switch again to stop the opening movement.

You can close the glass roof in a similar manner by pressing the switch forwards. The sliding visor remains open and can be closed by hand.

For Convenient opening and closing using the remote control, refer to 33.

After switching off the ignition

When the remote control is removed or the ignition is switched off, you can still operate the roof for approx. 1 minute as long as no door has been opened.

Pinch protection system

If the glass roof encounters an obstruction during closing from approximately the middle of the opening in the roof, or during closing from the tilted position, the closing movement is interrupted and the glass roof is opened again slightly.

 Despite the pinch protection system check and clear the roof's travel path prior to closing it; otherwise, the safety system might fail to detect certain kinds of obstructions, such as very thin objects, and the roof would continue closing. ◀

Closing without pinch protection

If there is an external danger, press the switch forward past the resistance point. The roof closes without pinch protection.

Following interruptions in electrical power supply

After a power failure, there is a possibility that the glass roof can only be tilted. The system must be initialized. BMW recommends having this work performed by your BMW center.

Convertible: retractable hardtop

The retractable hardtop combines reliable weather protection with simple and convenient operation.

The following tips will enhance your driving pleasure in your Convertible:

- ▷ It is advisable that you close the retractable hardtop when you park the vehicle. Not only does the closed hardtop protect the vehicle interior against unanticipated weather damage, it also offers theft protection. However, even when the hardtop is closed, valuables should only be stored in the locked trunk.
- ▷ Do not attach roof rack systems to the retractable hardtop, and in particular do not attach magnetic racks.
- ▷ Do not attach rack systems to the trunk lid, and in particular do not attach magnetic racks.
- ▷ When the retractable hardtop is operated, the trunk lid swings back and up. Before operating the retractable hardtop, ensure that there is enough clearance, e.g. when parked in front of a wall.
- ▷ If you open the hardtop while it is wet, e.g. after driving in the rain, water may drip into the trunk. If necessary, remove items from the trunk beforehand to avoid water stains or soiling.



Do not place any objects on the retractable hardtop or on the trunk lid; otherwise, they could fall during movements of the retractable hardtop and cause damage or injury. Never move the retractable hardtop when the rollover protection system is in the activated position.

Driving when the hardtop is not fully opened or closed may result in damage or injury.

Do not reach into the mechanism during the opening or closing procedure. Keep children away from the swiveling area of the retractable hardtop. ◀



The retractable hardtop cannot be moved at temperatures below +14 °F / -10 °C.

A message appears on the Control Display. ◀



The retractable hardtop can only be opened and closed when the vehicle is stationary. To avoid causing damage, do not drive off until the hardtop has stopped moving. ◀

Before opening and closing

- ▷ Comply with the safety precautions described above.
- ▷ Ensure that the trunk partition is folded down and engaged on both sides, refer to page 128; otherwise, it will not be possible to open the retractable hardtop.
- ▷ Do not place any objects near or on the trunk partition, refer to page 128.
- ▷ Close the storage compartment on the left side of the trunk.
- ▷ Observe the maximum loading height under the trunk partition.
- ▷ Ensure that the trunk lid is closed.
- ▷ The vehicle should be parked on fairly level ground. Excessive angle is indicated by a lamp.

! Before moving the hardtop, make sure that there are no objects on or next to the trunk partition, the storage compartment on the left side of the trunk is closed, and the maximum loading height in the trunk has not been exceeded; otherwise, damage may occur. ◀

Opening and closing

When the vehicle is stationary and at radio readiness or beyond, refer to page 62:

▷ If possible, conserve the battery by only operating the retractable hardtop when the engine is running.

Before closing the retractable hardtop, remove all foreign objects from the windshield frame as these could prevent the hardtop from closing properly. ◀



1 Push button: open the retractable hardtop.
Pull button: close the retractable hardtop.

2 LEDs

▷ The side windows move down when the switch for hardtop operation is pulled or pushed. ◀

LEDs

In the following situations, a message appears on the Control Display or an acoustic signal sounds in addition to the LED lighting up:

▷ While the hardtop is being operated, the left LED lights up green. It goes out as soon as the top is fully opened or closed.

- ▷** If the right-hand LED flashes red when you release the switch, the opening or closing action has not yet finished.
- ▷** If the right LED lights up red when the switch is pressed, the trunk partition is folded up, the trunk lid is not closed, the vehicle is standing on a strong incline or there is a malfunction. The retractable hardtop cannot be moved.

Interruption

The automatic sequence of movements is interrupted if the switch for hardtop operation is released. The sequence can be continued in the desired direction by pushing or pulling the switch.

! A hardtop that is not fully opened or closed is a safety hazard.

Do not interrupt and resume the closing procedure several times in close succession as this could damage the mechanism. ◀

▷ If the hardtop is not fully opened or closed, the trunk lid cannot be opened and the windows cannot be moved. ◀

Convenient opening and closing using the remote control

Refer to pages 34.

Wind deflector

The wind deflector keeps air movements in the passenger compartment to a minimum when the hardtop is open and provides an even more comfortable ride, particularly at high speeds.

Installation

The wind deflector is stored in a protective cover in the trunk. Brief instructions for operation can be found on the protective cover.

1. Remove the wind deflector from the protective cover and unfold it, arrows 1.

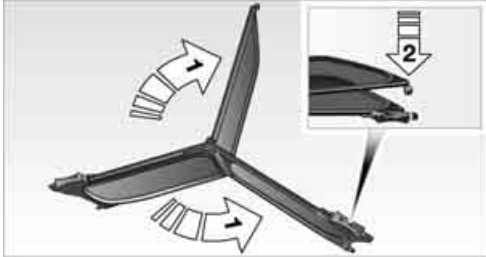

2. Press together the top and bottom parts of the wind deflector until the catch engages, arrow 2.

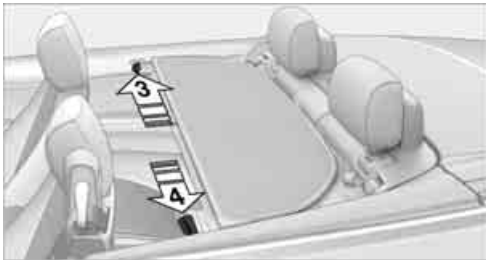

3. Push the fastening pin, arrow 3, into the opening provided on the right side of the vehicle until it snaps into place. Remove the protective caps beforehand, if necessary.
4. Push the fastening pin, arrow 4, into the opening provided on the left side of the vehicle until it snaps into place.



5. Turn the rotary handle in the direction of arrow 5 as far as the first stop to insert the right fastening pin into the holders.
6. Turn the rotary handle in the direction of arrow 6 as far as the  symbol to insert the left fastening pin into the holders.
7. Fold up the top section of the wind deflector.



With the wind deflector installed: do not recline the front-seat backrests too far if the seat is to be slid all the way back, as this would damage the wind deflector. ◀



Only turn the rotary handle within the range between the two symbols; otherwise, the cable system inside the wind deflector could be damaged. ◀

Removing the wind deflector

Proceed in the reverse order as used for installation.

Protective caps are provided in the vehicle for the holders of the wind deflector.

Folding

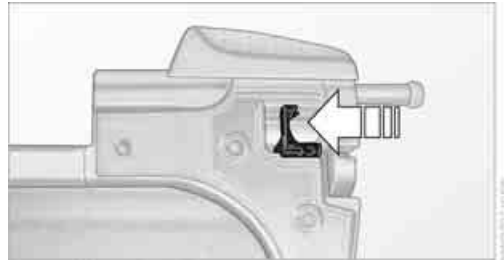



Slide the red release lever towards the middle of the wind deflector and push the two halves apart.

Loading function

Cargo can still be loaded on the rear seat of the vehicle even if the wind deflector has been installed.

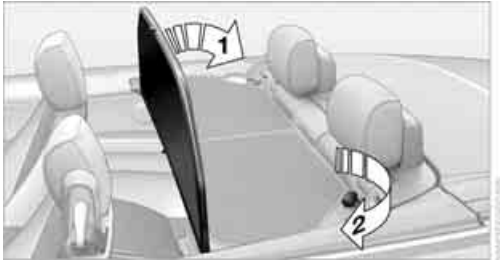
1. Lower all windows.
2. Fold down the top section of the wind deflector, arrow 1.



3. Turn the rotary handle to position , arrow 2.



Fold both sections of the wind deflector forward and rest them against the front seats, arrow 3.

To protect the seat cushions or to use the bag holders, you can fold the rear backrest down, refer to page [128](#).

Adjustments

Vehicle equipment

In this chapter, all production, country, and optional equipment that is offered in the model range is described. As a result, some equipment described may not be available in a particular vehicle, for example due to the options or national-market version selected. This also applies to safety related functions and systems.

Sitting safely

The ideal sitting position can make a vital contribution to relaxed, fatigue-free driving. In conjunction with the safety belts, the head restraints and the airbags, the seated position has a major influence on your safety in the event of an accident. To ensure that the safety systems operate with optimal efficiency, we strongly urge you to observe the instructions contained in the following section.

For additional information on transporting children safely, refer to page 58.

Airbags

 Always maintain an adequate distance between yourself and the airbags. Always grip the steering wheel on the rim, with your hands in the 3 o'clock and 9 o'clock positions, to minimize the risk of injury to the hands or arms in the event of the airbag being triggered off.

No one and nothing should come between the airbags and the seat occupant.

Do not use the cover of the front airbag on the front passenger side as a storage area. Make sure that the front passenger is sitting correctly, e.g. not resting feet or legs on the dashboard; otherwise, leg injuries can occur if the front airbag deploys.

Make sure that passengers keep their heads away from the side airbag and do not lean

against the cover of the head airbag; otherwise, serious injuries can result if the airbag deploys. ◀

Even if you follow all the instructions, injuries resulting from contact with airbags cannot be fully excluded, depending on the circumstances. The ignition and inflation noise may provoke a mild hearing loss in extremely sensitive individuals. This effect is usually only temporary.

For airbag locations and additional information on airbags, refer to page 107.

Head restraint

A correctly adjusted head restraint reduces the risk of neck injury in the event of an accident.

 Adjust the head restraint in such a way that its center is at approx. ear level. Otherwise, there is an increased risk of injury in the event of an accident. ◀

Head restraints, refer to page 51.

Safety belt

Before every drive, make sure that all occupants wear their safety belts. Airbags complement the safety belt as an additional safety device, but they do not represent a substitute.

Your vehicle has four seats, each of which is equipped with a safety belt.

 Never allow more than one person to wear a single safety belt. Never allow infants or small children to ride in a passenger's lap. Make sure that the belt in the lap area sits low across the hips and does not press against the abdomen.

The safety belt must not rest against the throat, run across sharp edges, pass over hard or fragile objects or be pinched. Fasten the safety belt so that it sits as snugly as possible against the lap and shoulder without being twisted. Otherwise, the belt could slide over your hips and

injure your abdomen in the event of a frontal collision.

Avoid wearing bulky clothing and regularly pull the belt in the upper-body area taut; otherwise, its restraining effect could be impaired. ◀

Safety belts, refer to page 54.

Seats

Note before adjusting

! Never attempt to adjust your seat while the vehicle is moving. The seat could respond with unexpected movement, and the ensuing loss of vehicle control could lead to an accident.

On the front passenger seat as well, do not incline the backrest too far to the rear while the vehicle is being driven; otherwise, there is a danger in the event of an accident of sliding under the safety belt, eliminating the protection normally provided by the belt. ◀

Comply with the instructions on head restraint height on page 51, and on damaged safety belts on page 54.

Manual adjustment

! Observe the adjustment instructions on page 49 to ensure the best possible personal protection. ◀

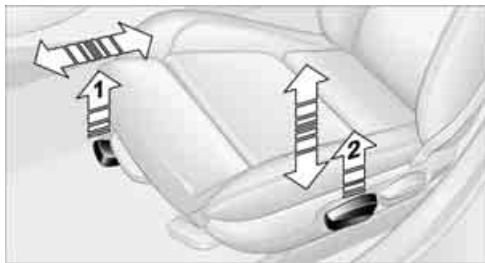

Longitudinal direction

Pull lever 1 and slide the seat to the desired position.

After releasing the lever, move the seat gently forward or back to make sure it engages properly.

Height

Pull lever 2 and apply your weight to the seat or lift it off, as necessary.

Backrest

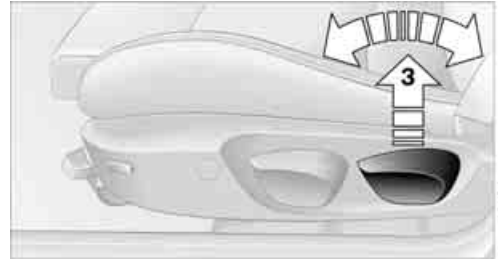

Pull lever 3 and apply your weight to the backrest or lift it off, as necessary.

Angle

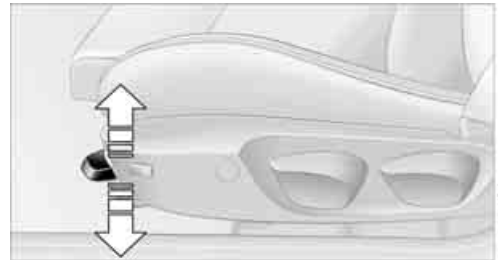

Pull the lever and apply your weight to the seat or lift it off, as necessary.

Thigh support

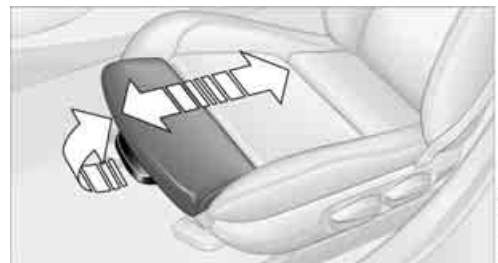

Pull the lever and move the thigh support forward or back.

Electrical adjustment

 Observe the adjustment instructions on page 49 to ensure the best possible personal protection. ◀

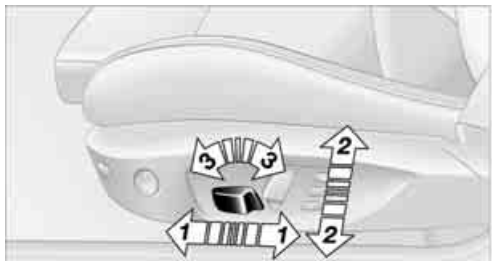

- 1 Longitudinal direction
- 2 Height
- 3 Angle

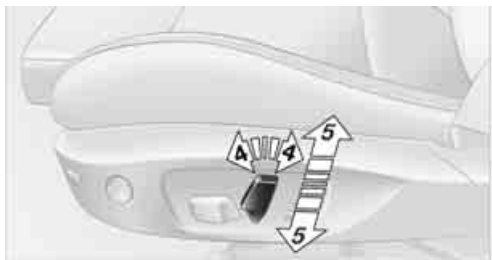

- 4 Backrest
- 5 Convertible: head restraints

Coupe: the head restraints are adjusted manually, refer to Head restraints below.

Lumbar support



You can also adjust the contour of the backrest to obtain additional support in the lumbar region.

The upper hips and spinal column receive supplementary support to help you maintain a relaxed, upright sitting position.

- ▷ Increase or decrease curvature: press the switch at the front or rear, respectively.
- ▷ Shift curvature up or down: press the switch at the top or bottom, respectively.

Backrest width



You can change the width of the backrest to suit your individual preferences by adjusting the lateral-support pads.

Press the front or rear end of the switch. Backrest width decreases or increases accordingly.

Longitudinal adjustment from outside/behind

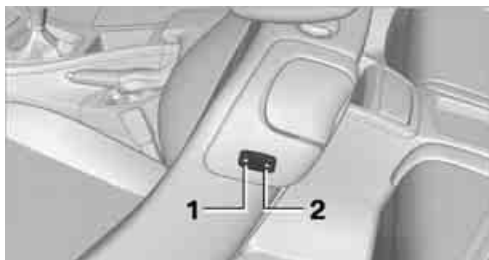

To move the front seats forward or backward from outside or from one of the rear seats: with the door open, press the front end **1** or rear end **2** of the switch.

Head restraints

Correctly adjusted head restraint

A correctly adjusted head restraint reduces the risk of neck injury in the event of an accident.

 Correctly adjust the head restraints of all occupied seats; otherwise, there is an increased risk of injury in an accident. ◀

Height

Adjust the head restraint so that its center is approximately at ear level.

Distance

Adjust the distance so that the head restraint is as close as possible to the back of the head.

Front active head restraints

In a rear collision of a sufficient strength, the active head restraint reduces the distance to the head.

 Do not use seat or head restraint covers that could impair the function of the active head restraint.

Do not hang any items, e.g. clothes hangers, directly on the head restraints. Attach only BMW approved accessories to the seat or head restraint.

Otherwise, the protective function of the active head restraint will not be ensured and its full potential in reducing the risk of injury in the event of a rear collision may not be realized.

In the event of faults, immobilization, or after the active head restraints have been triggered, have the testing, repair, or disassembly performed only by your BMW center or a workshop that has the required explosives licenses. Unprofessional attempts to work on the system could lead to failure in an emergency or to undesired airbag activation, either of which could result in personal injury. ◀

 For technical reasons, the head restraint cannot be removed. ◀

Coupe: front seats

Height adjustment

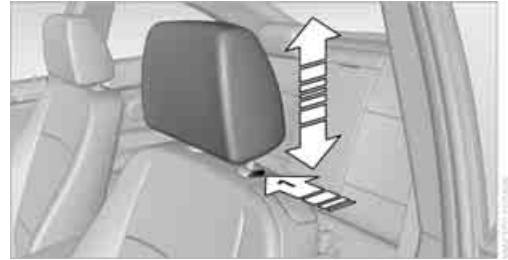

- ▷ To raise: pull up.
- ▷ To lower: press the button, arrow 1, and slide the head restraint down.

Convertible: front seats

Height adjustment

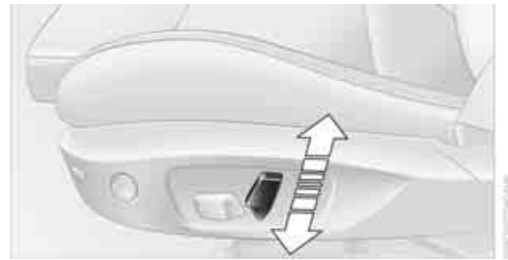

- ▷ To raise: press the button upward.
- ▷ To lower: press the button downward.

Adjusting the distance to the back of the head

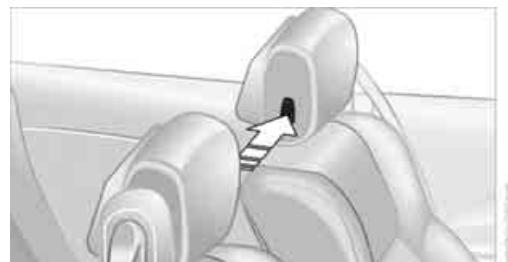

- ▷ Forward: pull up.
- ▷ Back: press the button and push the head cushion toward the rear.

 Do not insert objects behind the head cushion; otherwise, the head restraint may not function properly. ◀

Coupe: rear seats

Height adjustment

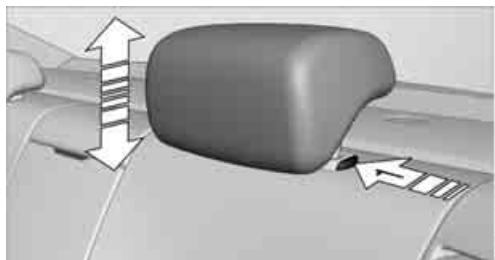

- ▷ To raise: pull up.
- ▷ To lower: press the button, arrow 1, and slide the head restraint down.

Removing

Only remove a head restraint if no one will be sitting on the seat in question.

1. Pull up as far as it will go.
2. Press the button, arrow 1, tilt the rear seat backrest slightly forward and pull the head restraint all the way out.

Entering the rear seats

Coupe: seat with manual longitudinal adjustment



Easy entry

The easy entry feature includes a memory function for the longitudinal adjustment and backrest angle.

1. Pull the lever and swing the backrest forward.
2. Push the seat forward.

Previous position

Push the seat backward and swing the backrest back.

 When pushing the seat into its rearmost position, make sure that no one is injured and that no objects are damaged. Before driving off, engage both seats and backrests so that they are locked in place. Otherwise, there is a risk of an accident due to unexpected movement. ◀

Seat with electrical longitudinal adjustment

Coupe

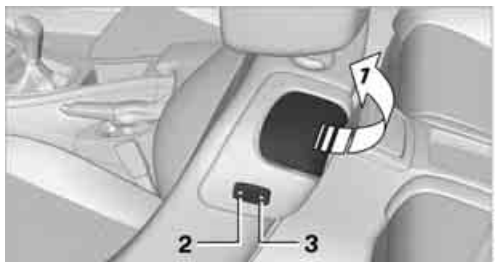

Convertible



Seat backrest warning lamp: Lights up when a seat backrest is not engaged. In addition, a message appears on the Control Display.

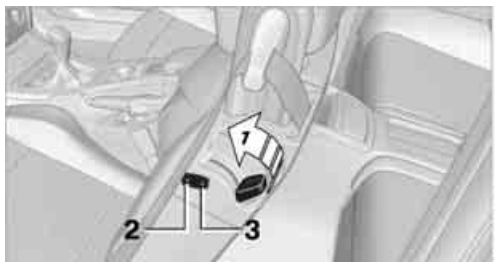

Easy entry

The easy entry feature includes a memory function for the longitudinal adjustment and backrest angle.

1. Pull lever **1** and swing the backrest forward.
2. Press the front end **2** of the switch until the seat has moved into the desired position.

Previous position

Press the rear end **3** of the switch until the seat automatically stops in its previous position, and fold the backrest back. If you release the switch before the previous seat position is reached, the seat will stop at its current position.

 When sliding the seat backward, make sure no one is injured and no objects are damaged.

Before driving off, engage both seats and backrests so that they are locked in place. Otherwise, there is a risk of an accident due to unexpected movement. ◀

Seat heating



Press the button once per temperature level. Three LEDs indicate the highest temperature.

To switch off:
Press button longer.

If you continue driving within approx. the next 15 minutes, the seat heating is automatically activated at the previously set temperature.

The temperature is lowered or the heating is switched off entirely to save on battery power. The LEDs stay lit.

Seat and mirror memory

You can store and call up two different combinations of driver's seat and exterior mirror positions.

Settings for the backrest width and lumbar support are not stored in memory.

Storing

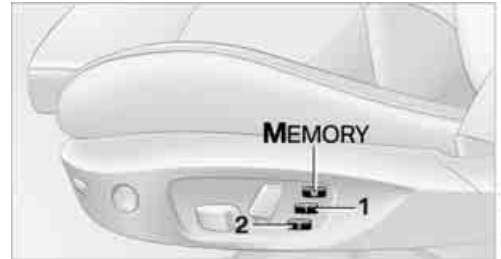

1. Switch on radio readiness or the ignition, refer to page 62.
2. Adjust the seat and exterior mirrors to the desired positions.
3. Press the  button. The LED in the button lights up.
4. Press the desired memory button **1** or **2**: the LED goes out.

The driver's seat and exterior mirror positions are stored for the remote control currently in use.

Call-up

 Do not call up the memory while you are driving; otherwise, unexpected seat movement could result in an accident. ◀

Comfort function

1. Unlock and open the driver's door or switch on radio readiness, refer to page 62.
2. Briefly press the desired memory button **1** or **2**.

The adjusting procedure is halted immediately when you touch a seat adjustment switch or one of the memory buttons.

Safety feature

1. Close the driver's door and switch the ignition on or off, refer to page 62.
2. Press the desired memory button **1** or **2** and keep it pressed until the adjustment process has been completed.

If the **M** button was pressed accidentally: Press the button again; the LED goes out.

Safety belts

 Observe the adjustment instructions on page 49 to ensure the best possible personal protection. ◀

Before every drive, make sure that all occupants wear their safety belts. Airbags complement the safety belt as an additional safety device, but they do not represent a substitute.



Closing

Make sure you hear the latch plate engage in the belt buckle.

The upper belt anchor is suitable for adults of any stature as long as the seat is adjusted properly, refer to page 49.

Opening

1. Grasp the belt firmly.
2. Press the red button in the buckle.
3. Guide the belt into its reel.

"Fasten safety belts" reminder for driver's and front passenger seat



The indicator lamps light up and an acoustic signal sounds. In addition, a message appears on the Control Display. Check whether the safety belt has been fastened correctly.

The 'Fasten safety belts' reminder is issued as long as the driver's safety belt has not been fastened. The "Fasten safety belts" reminder is also activated at road speeds above approx. 5 mph or 8 km/h if the front passenger safety belt is not fastened, if objects are placed on the front passenger seat, or if driver or front passenger unfasten their safety belts.

Damage to safety belts



If the safety belts are damaged or stressed in an accident: have the belt system, including any belt tensioners or child restraint systems, replaced and the belt anchors checked. Have this work carried out only at your BMW center. Otherwise correct operation of this safety equipment is not guaranteed. ◀

Coupe: belt hand-over

The concept

The belt hand-over makes it easier for you to fasten your safety belt. When you close the door and switch on radio readiness or the ignition, the belt hand-over extends automatically and presents the in a position that is convenient for fastening it around you. After you have fastened your safety belt, the belt hand-over retracts to its original position.

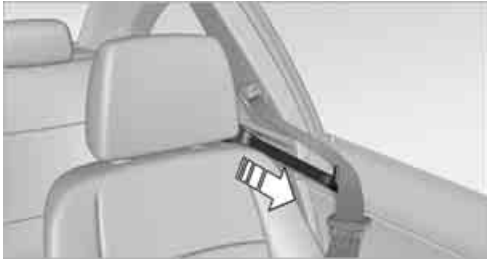

Even if you have not yet fastened your safety belt, the belt hand-over will retract if you:

- ▷ Wait for more than approx. one minute
- ▷ Open the corresponding door
- ▷ Start driving.

Closing the respective door reactivates the belt hand-over if the ignition or radio readiness is on.

Front passenger seat

The belt hand-over will extend only if the seat is occupied and after the front passenger door is closed.

Pinch protection system

If the belt hand-over encounters resistance on moving in or out, it moves back slightly in the opposite direction and stops in this position. To reactivate the belt hand-over: open and close the door or switch the ignition off and on.

 Although there is a pinch protection system, always check that the maneuvering area of the belt hand-over is clear. Otherwise it cannot be ensured that the system will stop moving in certain extreme situations. ◀

Mirrors

Exterior mirrors

 The front passenger's mirror is more convex than the driver's mirror. The objects seen in the mirror are closer than they appear. Do not gauge your distance from traffic behind

you on the basis of what you see in the mirror; otherwise, there is an increased risk of an accident. ◀

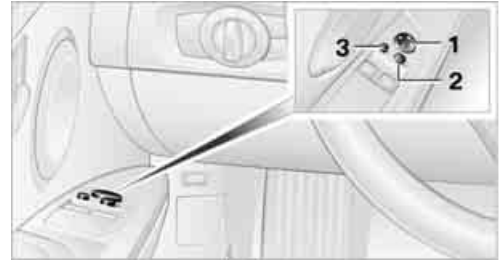

- 1 Adjustments
- 2 Switching to the other mirror or to the automatic curb monitor
- 3 Folding mirrors in and out

The setting for the exterior mirrors is stored for the remote control currently in use. The stored position is called up automatically when the vehicle is unlocked.

Manual adjustment

The mirrors can also be adjusted manually: press the edge of the glass.

Folding mirrors in and out

By pressing button **3**, you can fold the mirrors in and out at driving speeds up to approx. 12 mph or 20 km/h. This can be beneficial in narrow streets, for example, or for moving mirrors that were folded in by hand back out into their correct positions. Mirrors that have been folded in will fold out automatically at a speed of approx. 25 mph or 40 km/h.

 Before entering an automatic car wash, fold in the exterior mirrors manually or with button **3** to prevent them from being damaged, depending on the width of the vehicle. ◀

Automatic heating

Depending on the outside temperature, both exterior mirrors are heated automatically when the engine is running or the ignition is switched on.

Passenger side mirror tilt function – automatic curb monitor

Activating

1. Push the switch to the position for the driver's side mirror, arrow 1.

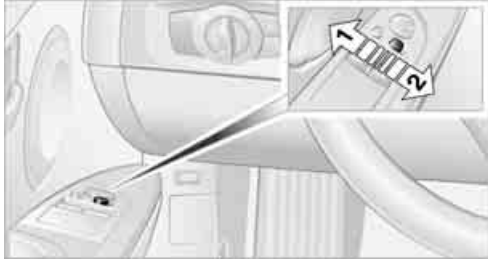

2. Shift into reverse or move the selector lever into the R position.
The glass of the mirror on the passenger side tilts slightly down. This allows the driver to see the area immediately adjacent to the vehicle, e.g. a curb, when backing into a parking space.

Deactivating

Push the switch to the position for the passenger side mirror, arrow 2.

Interior rearview mirror



Turn the knob to reduce glare from the headlamps of cars behind you when driving at night.

Interior and exterior mirrors, automatic dimming feature



The automatic dimming feature of the interior and exterior mirrors is controlled by two photo cells in the interior rearview mirror. One photo cell is in the mirror frame, see arrow; the other is on the back of the mirror.

In order to ensure that the system functions correctly, keep the photo cells clean, do not cover the area between the interior rearview mirror and windshield, and do not affix adhesive labels or stickers of any kind to the windshield directly in front of the mirror.

Steering wheel

Adjustments

 Do not adjust the steering wheel position while the car is in motion; otherwise, there is a risk of an accident due to unexpected movement. ◀

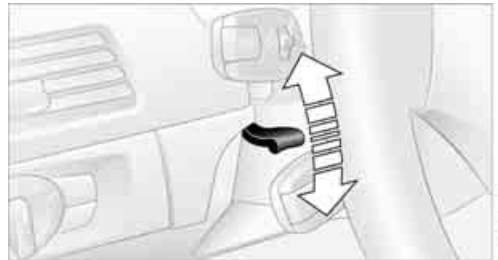

1. Fold the lever down.
2. Move the steering wheel to the preferred height and angle to suit your seated position.

3. Swing the lever back up.



Do not use force to swing the lever back up; otherwise, the mechanism will be damaged. ◀

Steering wheel heating



Press the button.

The LED in the button lights up when the steering wheel heating is switched on.

Transporting children safely

Vehicle equipment

In this chapter, all production, country, and optional equipment that is offered in the model range is described. As a result, some equipment described may not be available in a particular vehicle, for example due to the options or national-market version selected. This also applies to safety related functions and systems.

The right place for children



Do not leave children unattended in the vehicle; otherwise, they could endanger themselves and/or other persons by opening the doors, for example. ◀

Children should always sit in the rear

Accident research has shown that the safest place for children is on the rear seat.



Children under the age of 13 or smaller than 5 ft/150 cm may be transported only in the rear in suitable child restraint systems appropriate for their age, weight and size. Otherwise, there is an increased risk of injury in the event of an accident. ◀

Children 13 years of age or older must be buckled in with a safety belt as soon as there no longer is any child restraint system that is appropriate for their age, size and weight.

Children in the front passenger seat



Should it be necessary to use a child restraint system on the front passenger seat, the front and side airbags for the front passenger must be deactivated. Otherwise, a child traveling on that seat will face a significant risk of injury if the airbags are triggered off, even with a child restraint system. ◀

For more information on automatic deactivation of the front passenger airbags refer to page 107.

Convertible: key switch for passenger belt

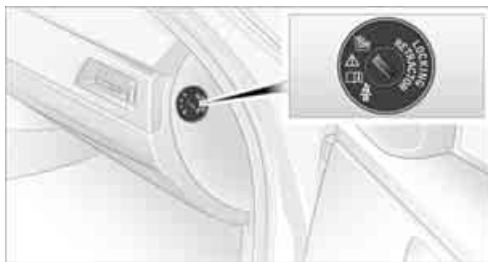

The passenger safety belt can be locked with a key switch so that it is prevented from being pulled out.

The key switch is situated on the side surface of the passenger-side dashboard.

Locking the passenger belt

Lock the passenger belt to install a child restraint system.

Insert key and push in.

Keep key pushed in and turn it until reaching the stop at the  position. Pull key out at this stop.





After removing the key, make sure that the switch is in the  position; otherwise, the locking action on the safety belt is not guaranteed. ◀

Unlocking the passenger belt

If no child restraint system is fastened to the front passenger seat, unlock the passenger belt; otherwise, the freedom of movement of the upper body is limited.

Insert key and push in.

Keep key pushed in and turn it until reaching the stop at the  position. Pull key out at this stop.

 Make sure that the passenger belt is unlocked; otherwise, the front passenger may become trapped by the safety belt. ◀

Installing child restraint systems

 Observe the child restraint system manufacturer's instructions when selecting, installing and using child restraint systems. Otherwise, the protective effect may be diminished. ◀

Standard child restraint systems are designed to be secured with a lap belt or with the lap-belt section of a lap-and-shoulder belt. Incorrectly or improperly installed child restraint systems can increase the risk of injury to children. Always follow the installation instructions for the system with the greatest care.

On the front passenger seat

 After installing a child restraint system on the front passenger seat, make sure that the front and side airbags for the front passenger are deactivated; otherwise, there is an increased risk of injury if the airbags deploy. ◀

Seat position

Before installing a child restraint system, move the front passenger seat as far back and up as possible to obtain the best possible position for the belt. Do not change the seat position after this.

Backrest width

 The backrest width of the front passenger seat must be at its widest possible setting. Do not change the setting after installing the child seat; otherwise, the child seat's stability on the front passenger seat is limited. ◀

1. Adjust the backrest width to its widest setting, refer to page 50.
2. Install the child seat.

Child seat security



The rear safety belts and the front passenger safety belt can be prevented from being pulled out in order to fasten child restraint systems.

To lock the safety belt

1. Secure the child restraint system with the belt.
2. Pull the belt strap all the way out.
3. Allow the belt strap to retract and pull it taut against the child restraint system.

The safety belt is locked.

To unlock the safety belt

1. Open the belt buckle.
2. Remove the child restraint system.
3. Allow the safety belt strap to retract all the way.

LATCH child restraint fixing system

LATCH: lower Anchors and Tethers for Children.

 To install and use the LATCH child restraint system, follow the operating and safety instructions provided by the manufacturer of the system; otherwise, the protective function of the seat may be compromised. ◀

Mounts for lower LATCH anchors

Before installing the child seat, pull the belt out of the area for the child restraint fixing system.

The lower anchors may be used to attach the CRS to the vehicle seat up to a combined child and CRS weight of 65 lb/30 kg when the child is restrained by the internal harnesses.

! Ensure that both lower LATCH anchors are correctly engaged and that the child restraint system is resting firmly against the backrest; otherwise, the protective function of the seat may be compromised. ◀



The mounts for the lower LATCH anchors are located behind the labeled protective caps.

Installing LATCH child restraint systems

- 1 Installing child restraint system, refer to the system operating instructions.
- 2 Make sure that both LATCH anchors are correctly locked in position.

Child restraint system with tether strap

Convertible

For Canadian Customers Only.

The following statement is required by Transport Canada.

This vehicle is not equipped with user-ready tether anchorages. As such neither a child restraint system, nor a booster cushion, requiring the use of a tether strap can be properly secured in the vehicle.

Coupe

! Use the tether strap anchors to secure child restraint systems only; otherwise, the anchors could be damaged. ◀

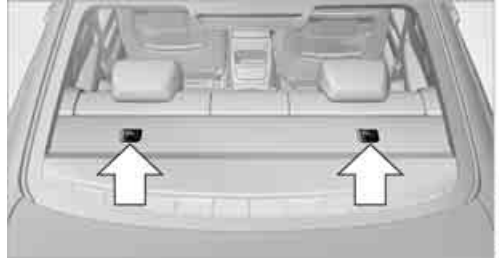

For child restraint systems with tether straps there are two additional anchors, see arrows.

Placement of the tether strap

Coupe

! Make sure the upper retaining strap does not run over sharp edges and is not twisted as it passes to the top anchor. Otherwise, the strap will not properly secure the child restraint system in the event of an accident. ◀

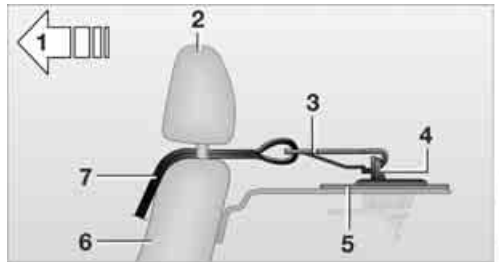

- 1 Direction of travel
- 2 Head restraint
- 3 Hook for upper retaining strap
- 4 Anchor
- 5 Rear window shelf
- 6 Seat backrest
- 7 Upper retaining strap of child restraint system

If necessary, fold the anchors upward before use.

1. Push the head restraint upward.
2. Guide the upper retaining strap between the head restraint holders.
3. Use the hook to clip the retaining strap to the anchor.
4. Push the head restraint into its lowermost position.
5. Pull the retaining strap taut.

Driving

Vehicle equipment

In this chapter, all production, country, and optional equipment that is offered in the model range is described. For this reason, descriptions will be given of some equipment that may not be available in a vehicle, for example due to the special options or national-market version selected. This also applies to safety related functions and systems.

Ignition lock

Insert the remote control into the ignition lock



Insert the remote control all the way into the ignition lock.

- ▷ Radio readiness is switched on.
Individual electrical consumers can operate.

Comfort Access

If the car is equipped with Comfort Access, only insert the remote control into the ignition lock under special circumstances, refer to page 40.

Removing the remote control from the ignition lock

- ⚠ Do not forcibly pull the remote control out of the ignition lock as this may cause damage. ◀

Before removing the remote control, push it all the way in to release the locking mechanism.

- ▷ The ignition is switched off if it was on.

Automatic transmission

You cannot take out the remote control unless the selector lever is in the P position: interlock.

Start/Stop button



Pressing the Start/Stop button switches radio readiness or the ignition on or off.

- ▷ Manual transmission: if you press the Start/Stop button and depress the clutch, the engine starts.

Automatic transmission and Sport automatic transmission with double clutch: when you press the Start/Stop button and depress the brake pedal, the engine starts. ◀

Radio readiness

Individual electrical consumers can operate. The time and the outside temperature are displayed in the instrument cluster.

Radio readiness is switched off automatically:

- ▷ When the remote control is removed from the ignition lock
- ▷ In cars with Comfort Access, by touching the surface above the door lock, refer to Locking on page 40

Ignition on

All electrical consumers can operate. The odometer and trip odometer are displayed in the instrument cluster.

 When the engine is off, please switch off the ignition and any unnecessary electrical consumers in order to preserve the battery. ◀

Radio readiness and ignition off

All indicator and warning lamps as well as displays in the instrument cluster go out.

Starting the engine

 Do not run the engine in enclosed areas; otherwise, the inhalation of toxic exhaust gases can cause loss of consciousness and death. The exhaust gases contain carbon monoxide, an odorless and colorless, but highly toxic gas. Never leave an unattended vehicle with the engine running; otherwise, such a vehicle represents a potential safety hazard. Before leaving the car with the engine running, place the transmission in neutral or move the selector lever to position P and forcefully apply the parking brake to prevent the car from moving. ◀

 Avoid frequent starting in quick succession as well as repeated start attempts in which the engine does not start. Otherwise, the fuel is not burned or incompletely burned and there is a danger of overheating and damaging the catalytic converter. ◀

Do not wait for the engine to warm up while the vehicle remains stationary. Start driving right away, but at moderate engine speeds.



Manual transmission

Remote control in the ignition lock or, with Comfort Access, inside the vehicle, refer to page 40.

1. Depress the brake.
2. Depress the clutch and shift into neutral.
3. Press the Start/Stop button.

The starter operates automatically for a certain time, and stops automatically as soon as the engine has started.

Automatic transmission

Remote control in the ignition lock or, with Comfort Access, inside the vehicle, refer to page 40.

1. Depress the brake.
2. Move the selector lever to position P.
3. Press the Start/Stop button.

The starter operates automatically for a certain time, and stops automatically as soon as the engine has started.

Sport automatic transmission with double clutch

Remote control in the ignition lock or, with Comfort Access, inside the vehicle, refer to page 40.

1. Depress the brake.
2. Press the Start/Stop button.

The engine starts independent of the current transmission position.

Switching off the engine

 When leaving the vehicle, always take along the remote control; this precaution prevents children from starting the engine, for example. ◀

 When parking, apply the parking brake forcefully; otherwise, the vehicle could begin to roll. On steep uphill and downhill inclines, also secure the vehicle by turning the wheels toward the curb, for example. ◀

Manual transmission

1. With the car at a standstill, press the Start/Stop button.
2. Shift into first gear or reverse.
3. Forcefully apply the parking brake.
4. Removing the remote control from the ignition lock, refer to page 62.

Automatic transmission

1. With the car at a standstill, move the selector lever to position P.
2. Press the Start/Stop button.
3. Forcefully apply the parking brake.
4. Removing the remote control from the ignition lock, refer to page 62.

Sport automatic transmission with double clutch

1. With the car at a standstill, press the Start/Stop button.
If the transmission is shifted into N when the engine is switched off, you will be notified visually and acoustically of this fact.
2. Forcefully apply the parking brake.
3. Remove remote control from the ignition lock, refer to page 62. The transmission is automatically shifted into transmission position P.

Parking brake

The parking brake is primarily intended to prevent the vehicle from rolling while parked; it brakes the rear wheels.

Also follow the instructions on page 64, under Switching off the engine.

Indicator lamp

 The indicator lamp is lit, and when you drive off an acoustic signal sounds in addition. The parking brake is still applied.

 Indicator lamp for Canadian models.

Applying

The lever locks in position automatically.

Releasing



Pull slightly upwards, press the button and lower the lever.

 In exceptional cases, if the parking brake has to be used to slow or stop the car, do not pull the lever up too hard. In doing so, continuously press the button of the parking brake lever.

Otherwise, excessive force on the parking brake can lock up the rear wheels and cause the rear of the car to swerve. ◀

 To prevent corrosion and one-sided braking action, occasionally apply the parking brake lightly when the vehicle is slowly coming to a stop if the traffic conditions are suitable. The brake lamps do not light up when the parking brake is applied. ◀

Manual transmission



 When shifting into 5th or 6th gear, press the gearshift lever to the right. Otherwise, the engine could be damaged if you inadvertently shift into 3rd or 4th gear. ◀

Reverse gear

Select this only when the vehicle is stationary. When the gearshift lever is pressed to the left, a slight resistance has to be overcome.

Automatic transmission with Steptronic

In addition to fully automatic operation, you can also manually shift with the Steptronic, refer to page 66.

Vehicle parking

 To prevent the vehicle from rolling, always select position P and apply the parking brake before leaving the vehicle with the engine running. ◀

Disengaging the remote control

In order to remove the remote control from the ignition lock, you must first move the selector lever to position P and switch off the engine: interlock. Removing the remote control from the ignition lock, refer to page 62.

Selector lever positions

P R N D M/S + -

Displays in the instrument cluster



The selector lever position is displayed and, in manual mode, the engaged gear, e.g. M4.

Changing selector lever positions

- ▷ With the ignition switched on or the engine running, the selector lever can be moved out of position P.
- ▷ Before moving the lever away from P or N with the vehicle stationary, first depress the brake; otherwise, the selector lever will refuse to move: shiftlock.

 To prevent the vehicle from creeping after you select a driving position, depress the brake until you are ready to start. ◀



A lock prevents you from inadvertently engaging selector lever positions R and P. To cancel the lock, press the button on the front of the selector lever, see arrow.

P Park

Select this only when the vehicle is stationary. The rear wheels are locked.

R Reverse

Select this only when the vehicle is stationary.

N Neutral

You can select this in a car wash, for example. The vehicle can roll.

D Drive, automatic position

Position for normal vehicle operation. All forward gears are selected automatically.

Under normal operating conditions, fuel consumption is lowest when you are driving in position D.

Kickdown

Kickdown enables you to achieve maximum performance. Press the accelerator pedal beyond the full-throttle resistance point.

Sport program and manual mode M/S



Move selector lever from position D toward the left into the M/S shifting slot; the Sport program is activated. This position is recommended for a performance-oriented driving style.

DS is displayed in the instrument cluster.

To deactivate the sport program or manual mode M/S, move the selector lever to the right into position D.

Shifting gears via the selector lever

Move selector lever from position D toward the left into the M/S shifting slot:

When you press the selector lever forwards or backwards, the manual mode is activated and Steptronic changes gear.

The engaged gear, e.g. M1 is displayed in the instrument cluster.

Upshifts and downshifts are executed only when they will result in a plausible combination of engine and vehicle speed; thus, for example, a downshift that would cause the engine to overrev will not be executed by the system.

The gear selected is briefly displayed in the instrument cluster, followed again by the gear actually in use.

Changing gears using shifting paddles on steering wheel

The shift paddles allow you to shift gears quickly since both hands can remain on the steering wheel.

- ▷ When you use the shift paddles on the steering wheel to shift gears in automatic mode, the transmission switches to manual mode.
- ▷ If you do not accelerate or shift gears using the shift paddles for a certain amount of time, the transmission switches back to automatic mode.

 If the selector lever is in the M/S gear plane, manual mode remains active. ◀

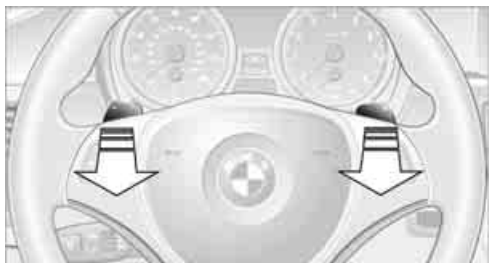

- ▷ To upshift, briefly pull the right shift paddle +.
- ▷ To downshift, briefly pull the left shift paddle -.

Upshifts and downshifts are executed only when they will result in a plausible combination of engine and vehicle speed; thus, for example, a downshift that would cause the engine to overrev will not be executed by the system.

The gear selected is briefly displayed in the instrument cluster, followed again by the gear actually in use.

Overriding selector lever lock

If the selector lever will not move out of position P even though the ignition is switched on, the brake is depressed, and the button on the selector lever is pressed, the selector lever lock can be overridden:

1. Switch off ignition.
2. Unclip the sleeve of the selector lever.
3. Pull the sleeve up over the selector lever until the sleeve is inside out.



4. Using the screwdriver from the onboard vehicle tool kit, refer to page 266, press the red lever and with the button pressed, simultaneously move the selector lever to the desired position.

7-gear Sport automatic transmission with double clutch

The concept

The 7-gear Sport automatic transmission with double clutch is an automated manual transmission with two clutches and secondary gear sets in which the clutching and shifting is handled by an electrohydraulic system. With the 7-gear Sport automatic transmission with double clutch, the gears are shifted without an interruption in driving power.

You operate the 7-gear Sport automatic transmission with double clutch using the selector lever and two shift paddles on the steering wheel.

It offers you the following functions:

- ▷ Either manual or automatic mode: sequential mode or drive mode
- ▷ Automatic downshifting and protection against incorrect gear selection, even in sequential mode
- ▷ Acceleration assistant, Launch Control, refer to page 71
- ▷ Automatic intermediate throttle application

System limitations

The 7-gear Sport automatic transmission with double clutch has an overheating protection that protects the clutch from extreme loads.



The indicator lamp lights up in yellow if the transmission becomes too warm.

Avoid high engine loads and frequent accelerations from zero. If the transmission is overheated, the indicator lamp lights up in red and the power flow to the motor is interrupted. It is only possible to continue driving once the transmission has cooled down.

Avoid frequent powerful accelerations from zero and do not hold the vehicle on inclines by pressing lightly on the accelerator while letting the clutch slip, as this may cause the transmission to overheat.

Selector lever positions

P R N D M/S + -

Displays in the instrument cluster



The selector lever position and the engaged gear are displayed, e.g. M4.

Engaging selector lever positions

- ▷ The selector lever can be moved out of position P only with the engine running: interlock.
- ▷ Before moving the lever away from P or N with the vehicle stationary, first depress the brake; otherwise, the desired shift will not be executed: shiftlock.

Shifting into N, D, R

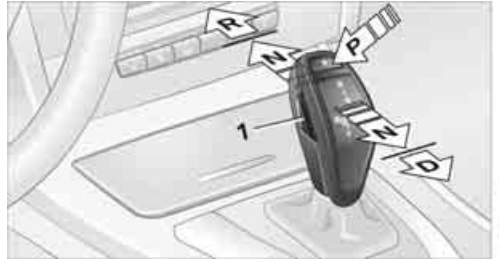

Briefly push the selector lever in the desired direction, overcoming a resistance point if necessary. When shifting out of P or into R, simultaneously press the button **1**.

The engaged selector lever position is also displayed on the selector lever.

When you release the selector lever, it returns to its center position.

Shifting into P

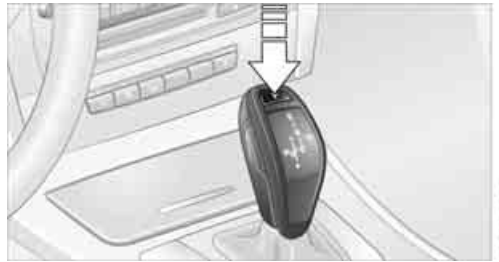

Press the button **P**.

P Park

Select this only when the vehicle is stationary. The rear wheels are locked.

- ▷ The transmission is shifted into P if, with the engine running, you open the driver's door, do not have your safety belt fastened, and subsequently actuate neither the brake pedal nor the accelerator. Before leaving the vehicle, make sure that the automatic transmission selector lever is in the park position. Otherwise, the vehicle may begin to move. ◀

 The transmission is shifted into P as soon as you switch off the engine, unless the transmission is in N and the remote control is in the ignition lock, refer to page 263. As soon as you remove the remote control from the ignition lock, then the transmission is shifted into P. ◀

R Reverse

Select this only when the vehicle is stationary.

N Neutral

You can select this in a car wash, for example. The vehicle can roll.

 After the engine is switched off, the transmission remains in N if you leave the remote control in the ignition lock. You can use this function at a car wash, for example, refer to page 263. ◀

D Drive mode

In Drive mode, all forward gears are shifted automatically.

Kickdown

For sudden acceleration maneuvers such as passing, depress the accelerator past the resistance point. This provides maximum acceleration.

Sport program and manual operation M/S



Push selector lever toward the left from the selector lever position D, the Sport program is activated. This position is recommended for a performance-oriented driving style.

The engaged gear, e.g. S1, is displayed in the instrument cluster.

When you press the selector lever forwards or backwards, the manual mode is activated and Steptronic changes gear.

The engaged gear, e.g. M1 is displayed in the instrument cluster.

In the following situations, the 7-gear Sport automatic transmission with double clutch does the thinking for you:

- ▷ Upshifts and downshifts are executed only when they will result in a plausible combination of engine and vehicle speed; thus, for example, a downshift that could cause the engine to overrev will not be executed by the system.
- ▷ At a stop, the transmission is automatically shifted down to the first gear.
- ▷ Shortly before the speed falls below a gear-dependent minimum speed, the transmission automatically downshifts without your intervention.

Quick downshifting: even in sequential mode, you can skip over several gears in order to achieve an optimum acceleration. To do so, depress the accelerator past the resistance point.

To return to automatic mode, push the selector lever to the right.

Gear shifting

Upshift or downshift using the selector lever or the shift paddles. You do not need to lift your foot off the accelerator when doing so.

Using the selector lever

- ▷ To upshift, pull the selector lever toward the rear.
- ▷ To downshift, push it toward the front.

Using the shift paddles on the steering wheel

You can also shift manually using two shift paddles on the steering wheel. The shift paddles allow you to shift gears quickly since both hands can remain on the steering wheel.

- ▷ When you use the shift paddles on the steering wheel to shift gears in automatic mode, the transmission switches to manual mode.
- ▷ If you do not accelerate or shift gears using the shift paddles for a certain amount of time, the transmission switches back to automatic mode if the selector lever is in position D.



- ▷ To upshift, briefly pull the right shift paddle +.
- ▷ To downshift, briefly pull the left shift paddle -.

Driving dynamics control

The driving dynamics control permits you, at the push of a button, to have your BMW react in an even more sporty fashion when driving:

- ▷ Optimal use is made of the engine's speed range.
- ▷ Gear changes occur more quickly.
- ▷ The engine reacts more spontaneously to accelerator pedal movements.

Activating the system



Press the SPORT button. The LED in the button lights up and SPORT appears in the info display.

Deactivating the system

- ▷ Press the SPORT button again.
- ▷ Switch off the engine.

The LED in the button goes out and SPORT disappears from the info display.

Manually unlocking parking lock

▶ In the event of a power supply interruption such as a discharged or disconnected battery or an electrical malfunction, the parking lock must be manually unlocked; otherwise, the rear wheels are immobilized and the vehicle cannot be towed. ◀

Only unlock the parking lock manually for towing and make sure to set the parking brake forcefully beforehand so that the vehicle cannot roll. Lock the parking lock again after the vehicle is parked.

Releasing

1. Unclip the sleeve of the selector lever.
2. Pull the sleeve up over the selector lever until the sleeve is inside out.



3. Using the allen wrench from the tool kit, refer to page 266, rotate the cover until it reaches the stop, arrow 1, and remove, arrow 2.



4. Insert allen wrench into the opening, arrow 1.

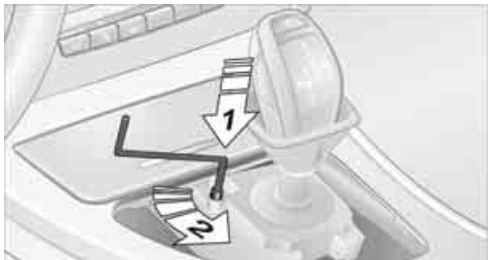

5. Rotate allen wrench until it reaches the stop, arrow 2. The parking lock is unlocked.

 Do not turn allen wrench in the opposite direction; otherwise, you may damage the mechanism. ◀

6. Remove allen wrench from the opening.

 After parking the vehicle, lock the parking lock again. Otherwise, there is a danger that the vehicle will roll. ◀

Locking

1. Press the button, see arrow. The parking lock is locked again.



2. Replace cover again.
3. Clip the selector lever sleeve back into place.
4. Forcefully apply the parking brake.

Jump starting and towing, starting on page 275.

Launch Control

Launch Control enables an optimum acceleration when starting off on a road surface with good traction.

 Do not use Launch Control too often; otherwise, the powerful stresses on the vehicle will lead to premature component wear. ◀

Launch Control is available when the engine is at operating temperature, i.e. after driving continuously for approx. 6.2 miles/10 km.

1. With the engine running, step on the brake with your left foot.
2. Activate Dynamic Traction Control (DTC), refer to page 98.
3. Activate Driving dynamics control, refer to page 70.
4. With the vehicle stationary, activate the manual mode and select 1st gear.

- With your right foot, push the accelerator pedal past the resistance point. The engine speed for pulling away is adjusted. A flag symbol appears in the instrument cluster.
- When you release the brake pedal, the vehicle accelerates. Keep the accelerator pedal floored.
- The upshifting occurs automatically as long as you keep the accelerator pedal pressed past the resistance point.

Launch Control will be ready for use again after you drive a certain distance.

Launch Control is not available for use during the break-in phase, refer to page 136.

 To maintain driving stability, keep DSC activated whenever possible. ◀

Turn signals/ headlamp flasher

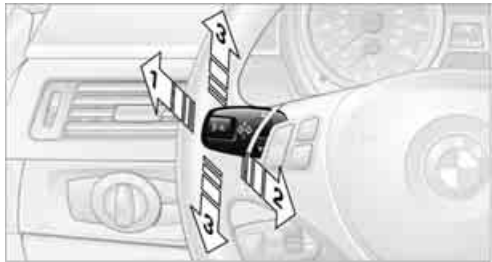

- High beams
- Headlamp flasher
- Turn signal

Using turn signals

Press the lever beyond the resistance point.

To turn off manually, press the lever to the resistance point.

 Unusually rapid flashing of the indicator lamp indicates that a turn signal indicator has failed. ◀

Signaling a turn briefly

Press the lever as far as the resistance point for as long as you wish to signal a turn.

Triple turn signal activation

Press the lever as far as the resistance point. The turn signals flash three times.

You can activate or deactivate this function.

- "Settings"
- "Lighting"
- "Triple turn signal"

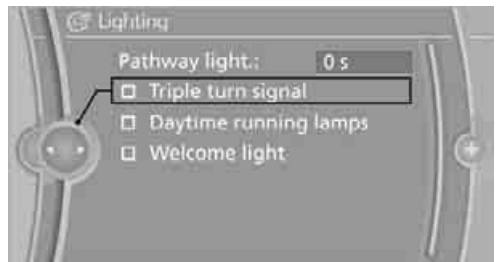

The setting is stored for the remote control currently in use.

Wiper system

 Do not switch on the wipers if they immobilized by ice; otherwise, damage to the wiper blades and wiper motor may occur. ◀

 Do not use the wipers when the window glass is dry; otherwise, the wiper blades may experience accelerated wear or damage. ◀

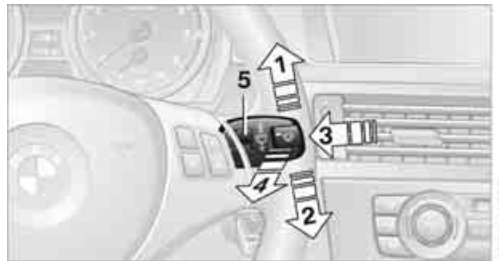

- 1 Switching on wipers
- 2 Switching off wipers or brief wipe
- 3 Activating/deactivating intermittent wipe or rain sensor
- 4 Cleaning windshield and headlamps
- 5 Setting speed for intermittent wipe or sensitivity of the rain sensor

Switching on wipers

Press the lever upward, arrow **1**.

The lever automatically returns to its initial position when released.

Normal wiper speed

Press once.

The system switches to operation in the intermittent mode when the vehicle is stationary.

Fast wiper speed

Press twice or press beyond the resistance point.

The system switches to normal speed when the vehicle is stationary.

Intermittent wipe or rain sensor

If the car is not equipped with a rain sensor, the intermittent-wipe time is a preset.

If the car is equipped with a rain sensor, the time between wipes is controlled automatically and depends on the intensity of the rainfall. The rain sensor is mounted on the windshield, directly in front of the interior rearview mirror.

Activating intermittent wipe or rain sensor

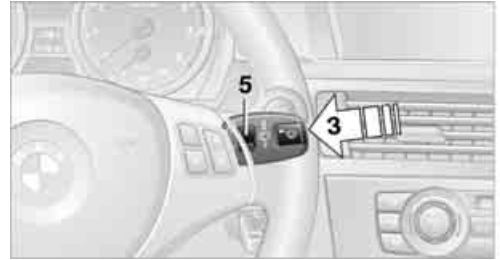

Press the button, arrow **3**. The LED in the button lights up.

Setting speed for intermittent wipe or sensitivity of the rain sensor

Turn thumbwheel **5** up or down.

Deactivating intermittent wipe or rain sensor

Press the button again, arrow **3**. The LED goes out.

 Deactivate the rain sensor before entering an automatic car wash. Failure to do so could result in damage caused by undesired wiper activation. ◀

Cleaning windshield and headlamps

Pull the lever, arrow **4**.

Washer fluid is sprayed onto the windshield and the wipers are operated for a short time.

When the vehicle lighting system is switched on, the headlamps are cleaned at regular and appropriate intervals.

 Do not use the washers if there is any danger that the fluid will freeze on the windshield. If you do, your vision could be obscured. Antifreeze should therefore be added to the fluid, refer to Washer fluid. Do not use the washers when the washer fluid reservoir is empty; otherwise, you will damage the washer pump. ◀

Windshield washer nozzles

Both windshield washer nozzles are automatically heated with the engine running or the ignition switched on.

Washer fluid

 Washer fluid antifreeze is flammable. Therefore, keep it away from ignition sources and only store it in the closed original container that is kept out of reach of children; otherwise, there is a risk of personal injury. Comply with the instructions on the container. ◀

United States: the washer fluid mixture ratio is regulated by the U.S. EPA and many individual states; do not exceed the allowable washer fluid dilution ratio limits that apply. Follow the usage instructions on the washer fluid container. Use BMW's Windshield Washer Concentrate or the equivalent.

Washer fluid filler neck

 Only add washer fluid after allowing the engine to cool and close the cover completely in order to prevent the washer fluid from contacting hot engine parts. Otherwise, fluid spills or leaks constitute a fire hazard and a risk to personal safety. ◀

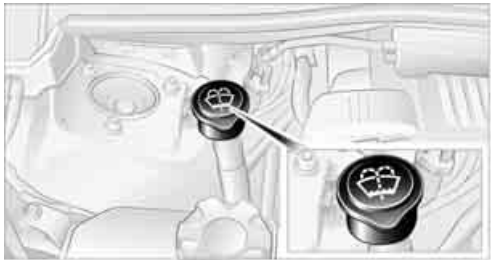

All washer nozzles are supplied with washer fluid by the same reservoir.

The recommended minimum filling quantity is 0.2 US gal/1 liter.

Fill with a mixture of window cleaner concentrate, tap water and, if required, with a washer antifreeze, according to manufacturer's recommendations.

Do not fill with undiluted window cleaner concentrate or with pure water since these can result in damage to the wiper system.

Do not mix window cleaner concentrates from different manufacturers since this may clog the washer nozzles.

Cruise control

The concept

Cruise control is available for use at speeds of approx. 20 mph or 30 km/h. The car then stores and maintains the speed that you specify using the lever on the steering column. In order to maintain the specified speed, the system brakes the vehicle when the engine braking effect is insufficient on downhill gradients.

 Do not use cruise control when driving at constant speed is prevented by adverse conditions, e.g. winding roads, dense traffic or poor road conditions due to, e.g., snow, rain, ice or loose surfaces. Otherwise, you could lose control of the vehicle and cause an accident as a result. ◀

Manual transmission

You can shift gears while cruise control is activated. The system is deactivated when you drive at very low engine speeds for an extended period.

One lever for all functions



- 1 Storing and maintaining speed or accelerating
- 2 Storing and maintaining speed or decelerating
- 3 Deactivating cruise control
- 4 Resuming a previously stored speed

Maintaining current speed

Briefly press the lever, arrow **1**, or pull it briefly, arrow **2**.

The car's current speed is stored and maintained. It is displayed on the speedometer and briefly in the instrument cluster.

On uphill gradients, it may prove impossible to maintain the set speed if current engine power output is insufficient. If the engine braking effect is insufficient on downhill slopes, the system will brake the vehicle slightly.

Increasing desired speed

Repeatedly press the lever to the resistance point or beyond, arrow **1**, until the desired speed is reached.

- ▷ Each time the lever is pressed to the resistance point, the desired speed is increased by approx. 1 mph or 1 km/h.
- ▷ Each time the lever is pressed beyond the resistance point, the desired speed is increased by up to 5 mph or 10 km/h.

The system stores and maintains the speed.

Accelerating using the lever

Accelerating slightly:

Press the lever to the resistance point, arrow **1**, until the desired speed is reached.

Accelerating significantly:

Press the lever beyond the resistance point, arrow **1**, until the desired speed is reached.

The vehicle accelerates without pressure on the accelerator pedal. The system stores and maintains the speed.

Decreasing speed

Repeatedly pull the lever to the resistance point or beyond, arrow **2**, until the desired speed is displayed.

- ▷ Each time the lever is pulled to the resistance point, the desired speed is decreased by approx. 1 mph or 1 km/h.
- ▷ Each time the lever is pulled beyond the resistance point, the desired speed is reduced by up to 5 mph or 10 km/h until the minimum speed of 20 mph or 30 km/h is achieved.

The system stores and maintains the speed.

Deactivating cruise control

Briefly press the lever upwards or downwards, arrow **3**.

The displays on the speedometer disappear.

In addition, the system is automatically deactivated:

- ▷ When the brakes are applied.
- ▷ When the manual transmission is shifted very slowly or shifted into neutral.
- ▷ When the automatic transmission selector lever is moved into the neutral position.
- ▷ When the selector lever of the sport automatic transmission with double clutch is moved into the neutral position.
- ▷ When DTC is activated or DSC is deactivated.
- ▷ When DSC or ABS is intervening.

Cruise control is not deactivated by depressing the accelerator pedal. Once the accelerator pedal is released, the stored speed is achieved again and maintained.

Warning lamp



The warning lamp lights up when cruise control is deactivated due to control intervention by the DSC, for example. A message appears on the Control Display.

Resuming a previously stored speed

Press the button, arrow 4.

The last stored speed is resumed and maintained.

In the following instances, the stored speed is deleted and can no longer be resumed:

- ▷ When driving stability control systems are intervening.
- ▷ In cars with manual transmission: when you shift gears very slowly or shift to neutral.
- ▷ In cars with automatic transmission: when you engage selector lever position N.
- ▷ In cars with Sport automatic transmission with double clutch: when you engage selector lever position N.
- ▷ When the ignition is switched off

Displays in the instrument cluster



- 1 Stored speed
- 2 Selected speed is displayed briefly



If --- mph or --- km/h temporarily appears in the instrument cluster display, it is possible that the system prerequisites for operation are currently not met.

Calling up Check Control messages, refer to page 93. ◀

Malfunction



The warning lamp lights up. A message appears on the Control Display. The cruise control is malfunctioning. You can continue your journey. Have the system checked.

Active Cruise Control

The concept

With Active Cruise Control, you can select a desired speed which is not only automatically maintained when driving on open roadways, but also varied to maintain a selected distance setting as slower traffic is encountered.

Active Cruise Control is a technological advance over the familiar cruise control and is a welcome relief from the constant adjustment of speed that can accompany driving in traffic on highways or other high-speed thoroughfares. Especially on longer trips, the system can reduce fatigue and tension, while increasing your enjoyment of driving. Please use it safely and responsibly.

Within the limits of its capability, the system automatically adapts the car's speed to that of a slower vehicle in front of you. You can specify the distance to be maintained from the vehicle in front in four stages. For safety reasons, the distance is speed-dependent. Based on your selected distance setting, the system automatically decreases the throttle setting and lightly applies the brakes if necessary. The vehicle brake lamps will automatically illuminate to signal a following driver to take action. In addition, it may be necessary for the vehicle or the driver to downshift, depending on the kind of trans-

mission your vehicle is equipped with, to maintain the distance setting selected. If the vehicle ahead speeds up or when the lane ahead becomes clear, your vehicle will accelerate to the speed you have selected by increasing the throttle setting and shifting gears automatically or by the driver as needed. Your selected speed will be held when driving downhill, too.

Since this Active Cruise Control system is a new technology and operates differently from conventional cruise control systems which you may be accustomed to, you are strongly urged to read all of the pages relating to this system before use. Pay special attention to the System limitations section beginning on page 81.

Braking sensation

- ▷ If you step on the brake pedal while the system is braking, pedal sensation will be slightly different from the usual.
- ▷ Possible noises during automatic braking are normal.

Manual transmission

You can shift gears while cruise control is activated. The system is deactivated when you drive at very low engine speeds for an extended period.

Range of applications

The minimum desired speed is 20 mph or 30 km/h, the maximum desired speed is 110 mph or 180 km/h.

 As with conventional cruise control systems, Active Cruise Control in no way diminishes or substitutes for the driver's own personal responsibility, alertness and awareness in adjusting speed, braking or otherwise controlling the vehicle. The driver should decide when to use the system on the basis of road, traffic, visibility, and weather conditions. Active Cruise Control is intended for use on highway-type roadways where traffic is moving relatively smoothly. Do not use this system in city driving; heavy traffic such as during rush

hour; on curvy, winding roads, slippery roads or roads with sharp curves such as highway off-ramps; during inclement weather such as snow, strong rain or fog; or when entering interchanges, service/parking areas or toll booths. It is also important to regulate your vehicle's speed and distance setting within applicable legal limits. Always be ready to take action or apply the brakes if necessary, especially when the system is actively following a vehicle in front of you. Otherwise, driving situations could result that pose the risk of accidents. ◀

One lever for all functions

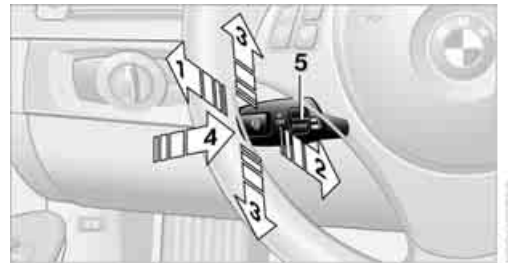

- 1 Store and increase desired speed
- 2 Store and decrease desired speed
- 3 Deactivate system, refer to page 79
- 4 Resume stored desired speed and distance, refer to page 79
- 5 Select distance to vehicle driving ahead, refer to page 78

Storing current speed

Briefly press the lever, arrow **1**, or pull the lever, arrow **2**, at a driving speed of more than approx. 20 mph or 30 km/h.



The car's current speed is stored. It is displayed on the speedometer and briefly in the instrument cluster.

Increasing desired speed

Press or briefly press the lever to the resistance point or beyond, arrow **1**, until the desired speed is displayed.

- ▷ Each time the lever is briefly pressed to the resistance point, the desired speed is increased by approx. 1 mph or 1 km/h.
- ▷ Each time the lever is briefly pressed beyond the resistance point, the desired speed is increased by up to 5 mph or 10 km/h until the maximum speed of 110 mph or 180 km/h is achieved.

The speed then displayed is stored and achieved on a clear road.

Decreasing desired speed

Pull the lever, arrow **2**, until the desired speed is displayed.

The other functions work analogously to those described under Increasing desired speed.

Selecting distance

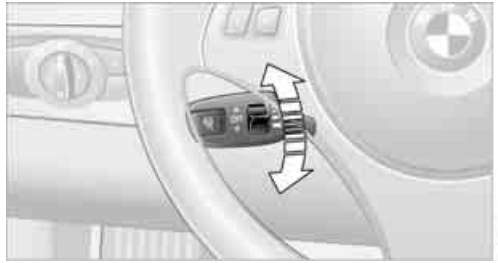

- ▷ Press downward:
Increase distance.
- ▷ Press upward:
Decrease distance.

The selected distance is displayed in the instrument cluster.



Distance 1



Distance 2



Distance 3



Distance 4

This is always the preset distance when you use the system for the first time after starting the engine.



Use good judgment to select the appropriate following distance given road conditions, traffic, applicable laws and driving recommendations for safe following distance. Otherwise, an accident risk could result. ◀

Deactivating cruise control

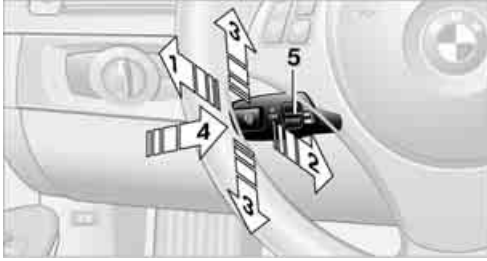

Press the lever upward or downward, arrow **3**. The displays on the speedometer disappear.

In addition, the system is automatically deactivated:

- ▷ When the brakes are applied.
- ▷ When the speed is reduced to below 20 mph or 30 km/h due to a traffic situation.
- ▷ When the manual transmission is shifted very slowly or shifted into neutral.
- ▷ When the automatic transmission selector lever is moved into the neutral position.
- ▷ When the selector lever of the sport automatic transmission with double clutch is moved into the neutral position.
- ▷ When Dynamic Traction Control DTC is activated.
- ▷ When Dynamic Stability Control DSC is deactivated.
- ▷ When DSC or ABS is intervening.
- ▷ When the system does not recognize any objects for a longer time, e.g. on infrequently traveled roads without a shoulder or guard rails, or if the radar sensor is covered with dirt, refer to page **80**.
- ▷ When the parking brake is engaged.

 When the system is deactivated, you must brake the vehicle yourself and/or maneuver as necessary; otherwise, there is a risk of accidents. ◀

Warning lamp



The warning lamp lights up when Active Cruise Control has been automatically deactivated, for example due to a driving speed below 20 mph or 30 km/h or a DSC intervention. A message appears on the Control Display.

Resuming stored desired speed and distance

Briefly press the button, arrow **4**.

The stored speed and distance are regained and maintained.

In the following instances, the stored speed is deleted and can no longer be resumed:

- ▷ When driving stability control systems are intervening.
- ▷ In cars with manual transmission: when you shift gears very slowly or shift to neutral.
- ▷ In cars with automatic transmission: when you engage selector lever position N.
- ▷ In cars with Sport automatic transmission with double clutch: when you engage selector lever position N.
- ▷ When the ignition is switched off.

Displays in the instrument cluster



- 1** Stored desired speed
- 2** Shows yellow: vehicle detected ahead
Flashes in red: system cannot maintain distance; driver must brake the vehicle
Flashes in yellow: driving stability control systems are intervening; cruise control is deactivated

- 3 Selected distance to vehicle ahead
The indicator lights up as soon as the system is activated.
- 4 Selected desired speed is temporarily displayed

 If --- mph or --- km/h temporarily appears in the instrument cluster display, it is possible that the system prerequisites for operation are currently not met. Calling up Check Control messages, refer to page 93. ◀

Warning lamps



The indicator **2** flashes in red; a signal sounds.

The system indicates that you must brake and/or maneuver the vehicle yourself. Active Cruise

Control cannot automatically restore the distance to the vehicle ahead.

This indicator does not release you from your responsibility to adapt your desired speed and driving style to prevailing driving conditions.



The indicator **2** flashes in yellow. The prerequisites for operating Active Cruise Control are not met, e.g. as a result of ABS or DSC interventions. Active Cruise Control is deactivated. You can reactivate the system, if desired, by briefly pressing or pulling the lever when road and traffic conditions permit. It is not possible to resume a stored speed.

Radar sensor



The sensor's ability to detect vehicles ahead may be restricted as a result of heavy rain, dirt, snow or ice. If necessary, clean the radar sensor located in the front bumper, see arrow. Be sure to use particular care when removing any layers of snow or ice from the sensor.

The system cannot be activated if the sensor is incorrectly aligned.

For US owners only

The transmitter and receiver units comply with part 15 of the FCC/Federal Communications Commission regulations. Operation is governed by the following:

FCC ID:

NF3 ACC2SCU 003YK04001 0000

Compliance statement:

This device complies with part 15 of the FCC Rules. Operation is subject to the following two conditions:

- ▶ This device must not cause harmful interference, and
- ▶ this device must accept any interference received, including interference that may cause undesired operation.



Any unauthorized modifications or changes to these devices could void the user's authority to operate this equipment. ◀

Malfunction



The warning lamp lights up. A message appears on the Control Display. Active Cruise Control failed. Have the system checked.

System limitations

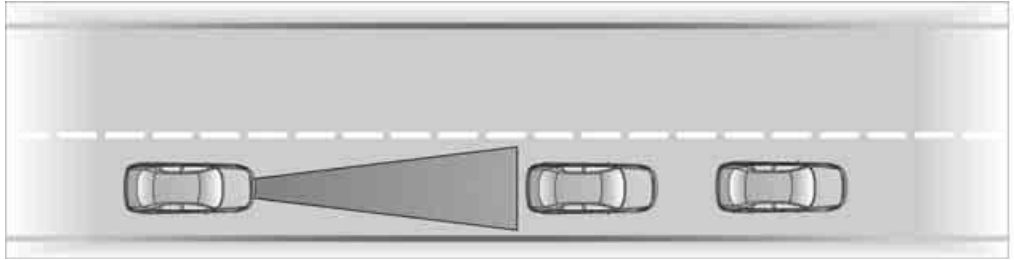

! Always remember that the range and ability of the system does have physical limitations. It will not apply the brakes or decelerate your vehicle when there is a slow-moving vehicle, stopped vehicle, or stationary object ahead of you, for example at a traffic light or when approaching a parked vehicle. Also, the system does not react to oncoming traffic, pedestrians or other types of potential traffic such as a rider on horseback. The system may also not detect smaller moving objects such as motorcycles or bicycles. Be especially alert when encountering any of these situations as the system will neither automatically brake, nor provide a warning to you. Also, be aware that every decrease in the distance setting allows your vehicle to come closer to a vehicle in front of you and requires a heightened amount of alertness. ◀

! Active Cruise Control is not and must not be used as a collision avoidance/warning system. ◀

If while your vehicle is actively following a vehicle in front of you and the vehicle ahead speeds up or the lane ahead becomes clear, then your vehicle will accelerate to the speed you have selected. Be aware that changing to a clear, unobstructed lane will also result in your vehicle accelerating.

! Be certain to deactivate the system when you pull into an exit lane for a highway off-ramp. ◀

Also, vehicles traveling in a staggered manner on a highway may cause a delay in the system's reaction to a vehicle in front of you or may cause the system to react to a vehicle actually in the lane next to you. Always be ready to take action or apply the brakes if necessary.

! While Active Cruise Control is capable of braking your vehicle automatically when you approach a slower vehicle ahead, it is important to be aware that the ability of the system to apply the brakes is also limited, e.g. when you reduce your desired speed sharply. The system cannot stop your vehicle. It uses only a portion of braking system capacity and does not utilize the full capacity of the vehicle braking system. Therefore, the system cannot decrease your speed for large differences in speed between your vehicle and the vehicle ahead. Examples: when you approach a vehicle traveling at a much lower speed than your own speed such as approaching a toll booth or when a much slower vehicle cuts in front of you at close range. ◀

Active Cruise Control can only decelerate the vehicle to approx. 20 mph or 30 km/h.

Swerving vehicles

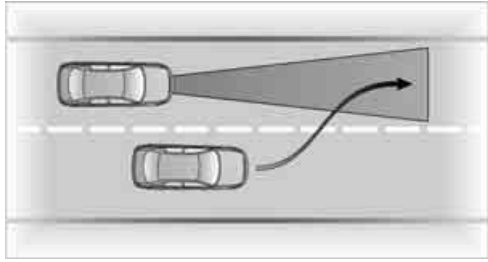

When a vehicle moves from an adjacent lane into your lane, Active Cruise Control will not recognize this vehicle until it is fully in your lane ahead of your vehicle.

! When a vehicle ahead suddenly swerves into your lane, the system may not be able to maintain the selected distance automatically. This also applies to great differences in speed between you and vehicles ahead, e.g. when quickly approaching a truck. There is a risk of collision. Once the system has established that a vehicle is indeed in front of you, it will indicate that you must brake and/or maneuver the vehicle yourself. Take action yourself; otherwise, there is a risk of an accident. ◀

Behavior in curves

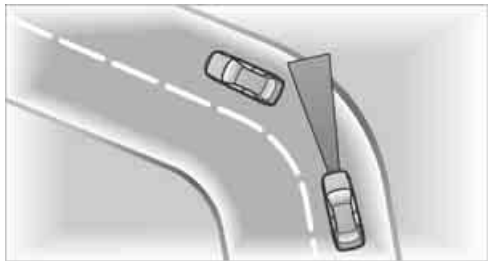

Because of the limited range of the system, it is possible that in curves or on the peaks and valleys of hilly roads, a vehicle ahead may be recognized late, or not at all. Therefore, it is up to the driver to select a speed that is prudent in view of the curves and terrain of the roadway.



In approaching a curve, it is possible that Active Cruise Control would react briefly to a vehicle in the adjacent lane. In addition, the system can sense if your vehicle is in a curve and may not accelerate. If your vehicle decelerates in either case, you can choose to overcome the deceleration by briefly pressing the accelerator pedal.

Your responsibility

Your actions have priority at all times. When you press the accelerator pedal while driving with Active Cruise Control, the automatic braking function will be temporarily interrupted. Once you release the accelerator pedal, the desired speed or the selected distance to the vehicle ahead is achieved again.

! Do not leave your foot on the accelerator pedal and make sure that no objects such as floor mats are lying on the accelerator pedal. Otherwise, the system may not be able to brake the vehicle. ◀

Controls overview

Vehicle equipment

In this chapter, all production, country, and optional equipment that is offered in the model range is described. For this reason, descriptions will be given of some equipment that may not be available in a vehicle, for example due to the special options or national-market version selected. This also applies to safety related functions and systems.

Odometer, outside temperature display, clock



- 1 Knob in the instrument cluster
- 2 Outside temperature display and clock
- 3 Odometer and trip odometer

Knob in the instrument cluster

- ▷ To reset the trip odometer while the ignition is switched on
- ▷ To display the time, outside temperature and odometer briefly while the ignition is switched off

Units of measure

To select the respective units of measure, miles or km for the odometer as well as °F or °C for the outside temperature, refer to page 88.

The setting is stored for the remote control currently in use.

Time, outside temperature display

Setting the time, refer to page 90.

Outside temperature warning

When the displayed temperature sinks to approx. +37 °F / +3 °C, a signal sounds and a warning lamp lights up. There is an increased risk of black ice.

 Black ice can also form at temperatures above +37 °F / +3 °C. You should therefore drive carefully on bridges and shaded roads, for example; otherwise, there is an increased risk of an accident. ◀

Odometer and trip odometer

Resetting the trip odometer:

With the ignition switched on, press button 1 in the instrument cluster.

When the vehicle is parked

If you still want to view the time, outside temperature and odometer reading briefly after the remote control has been taken out of the ignition lock:

Press button 1 in the instrument cluster.

Tachometer



Never force the engine speed up into the red warning field, see arrow. In this range, the fuel supply is interrupted to protect the engine.

Engine oil temperature



When the engine is at normal operating temperature, the engine oil temperature is between approx. 210 °F / 100 °C and approx. 300 °F / 150 °C.

If the engine oil temperature is too high, a message appears on the Control Display.

Fuel gauge



Fuel tank capacity: approx. 16.1 US gal / 61 liters.

You can find information on refueling on page 233.

If the tilt of the vehicle varies for a longer period, when you are driving in mountainous areas, for example, the indicator may fluctuate slightly.

Reserve

Once the fuel level has fallen to the reserve zone, a message briefly appears on the Control Display and the cruising range for the remaining amount of fuel is displayed on the computer. Under a cruising range of approx. 30 miles / 50 km, the message remains in the Control Display.

With a dynamic driving style, e.g. rapid cornering, engine functions are not always assured.



Refuel as soon as possible once your cruising range falls below 30 miles / 50 km; otherwise, engine functions are not ensured and damage can occur. ◀

Computer

Displays in the instrument cluster

Calling up information



Press the button in the turn signal/high beam lever.

The following items of information are displayed in the order listed:

- ▷ Cruising range
- ▷ Average speed
- ▷ Average fuel consumption
- ▷ Current fuel consumption
- ▷ No information

To set the corresponding units of measure, refer to Units of measure on page 88.

Cruising range

Displays the estimated cruising range available with the remaining fuel. The range is calculated on the basis of the way the car has been driven over the last 18 miles/30 km and the amount of fuel currently in the tank.

 Refuel as soon as possible once your cruising range falls below 30 miles/50 km; otherwise, engine functions are not ensured and damage can occur. ◀

Average speed

Periods with the vehicle parked and the engine switched off are not included in the calculations of average speed.

With the trip computer, refer to page 86, you can have the average speed for another trip displayed.

To reset average speed: press the button in the turn signal/high beam lever for approx. 2 seconds.

Average fuel consumption

The average fuel consumption is calculated for the time during which the engine is running.

You can have the average consumption for another trip displayed, refer to Displays on the Control Display below.

To reset average fuel consumption: press the button in the turn signal/high beam lever for approx. 2 seconds.

Current fuel consumption

Displays the current fuel consumption. This allows you to see whether your current driving style is conducive to fuel economy with minimum exhaust emissions.

Displays on the Control Display

The computer can also be opened via iDrive.

1. "Vehicle Info"
2. "Onboard info" or "Trip computer".



Displaying "Onboard info":

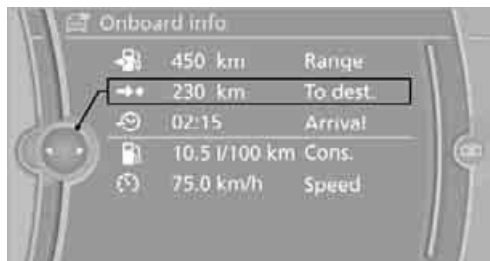

- ▷ Cruising range
- ▷ Distance from destination
- ▷ Estimated time of arrival if a destination has been entered in the navigation system.

Displaying "Trip computer":

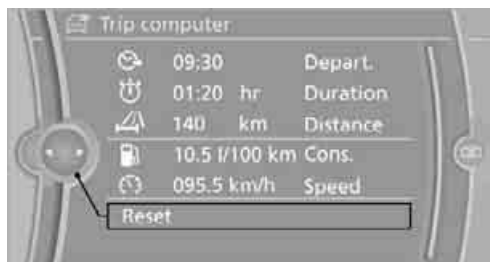

- ▷ Departure time
- ▷ Trip duration
- ▷ Trip distance

Both displays show:

- ▷ The average speed and
- ▷ the average fuel consumption.

Resetting the fuel consumption and speed

You can reset the values for average speed and average consumption:

1. Select the respective menu entry.
2. Press the controller to confirm your selection.

Resetting the trip computer

You can reset all values:

1. "Vehicle Info"
2. "Trip computer"
3. "Reset"

Settings and information

Operating principle



- | | |
|--|---|
| <p>1 Button for:</p> <ul style="list-style-type: none"> ▷ Selecting display ▷ Setting values <p>2 Button for:</p> <ul style="list-style-type: none"> ▷ Confirming selected display or set values ▷ Calling up computer information 85 <p>3 When the lights are on: instrument lighting brightness 114</p> <p>4 Calling up Check Control 92</p> | <p>5 Checking oil level 256</p> <p>6 Setting the time 90</p> <p>7 Setting the date 92</p> <p>8 Viewing service requirement display 88</p> |
|--|---|

Exiting displays

The outside temperature reading and the time reappear when you press button **2** or if you make no entries within approx. 15 seconds. If required, complete the current setting first.

Units of measure

You can change the units for fuel consumption, route/distance, temperature and pressure.

1. "Settings"
2. "Language/Units"

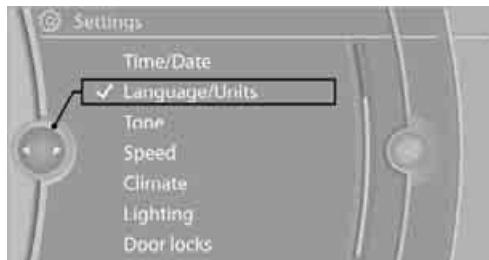

3. Select the desired menu item.
4. Select the desired unit.

The settings are stored for the remote control currently in use.

Service requirements



The remaining driving distance and the date of the next scheduled service are displayed briefly immediately after you start the engine or switch on the ignition.

 The extent of service work required can be read out from the remote control by your dealership Service Advisor. ◀

For certain maintenance operations, you can view the respective distance remaining or due date individually in the instrument cluster.



1. Switch on the ignition, refer to page 62.
2. Push button 1 in the turn signal/high beam lever up or down repeatedly until the appropriate symbol appears in the display, accompanied by the words "SERVICE-INFO".
3. Press button 2.
4. Use button 1 to scroll through the individual service items.

Possible displays



- 1 Button for selecting functions
- 2 Service requirements
- 3 Engine oil
- 4 Roadworthiness test
- 5 Front brake pads
- 6 Rear brake pads
- 7 Brake fluid

The sequence of displayed service items may vary. The data for the next service appointment is shown first.

More information

Detailed information on service requirements

You can call up additional information on the maintenance regimen on the Control Display.

1. "Vehicle Info"
2. "Vehicle status"



3. "Service required"

Required maintenance procedures and legally mandated inspections are displayed.

You can request more detailed information on every entry:

Select the entry and press the controller.

To exit from the menu:

Move the controller to the left.

Symbols



No service is currently required.



The deadline for service or a legally mandated inspection is approaching.



The service deadline has already passed.

Entering deadlines for legally required inspections

Make sure the date on the Control Display is set correctly, refer to page 92; otherwise, the effectiveness of CBS Condition Based Service is not ensured.

1. "Vehicle Info"
2. "Vehicle status"
3. "Service required"



4. "§ Vehicle inspection"

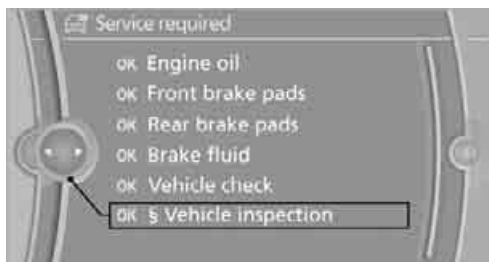

5. Open the menu for entering the deadline.
6. "Date:"
7. Create the settings.
8. Press the controller to apply the setting. The year is highlighted.

9. Turn the controller to make the adjustment.
10. Press the controller to apply the setting. The date entry is stored.

To exit from the menu:
Move the controller to the left.

More information on the BMW Maintenance System can be found on page 260.

Automatic Service Request

Data regarding the maintenance status or legally mandated inspections of the vehicle are automatically transmitted to your BMW center prior to a service due date.

You can check when your BMW center was notified.

1. "Vehicle Info"
2. "Vehicle status"



3. "Options"
4. "Last Service Request"

Clock

The settings are stored for the remote control currently in use, refer also to Personal Profile on page 32.

Setting the time

In the instrument cluster

To set the 12h/24h mode, refer to Setting the time format below.



1. Push button **1** in the turn signal/high beam lever up or down repeatedly until the appropriate symbol appears in the display, accompanied by the time and the word "SET".
2. Press button **2**.
3. Use button **1** to set the hours.
4. Press button **2** to confirm the entry.
5. Use button **1** to set the minutes.
6. Press button **2** to confirm the entry.
7. Press button **2**.
The system accepts the new time.

Via iDrive

1. Press the **MENU** button.
The main menu is displayed.

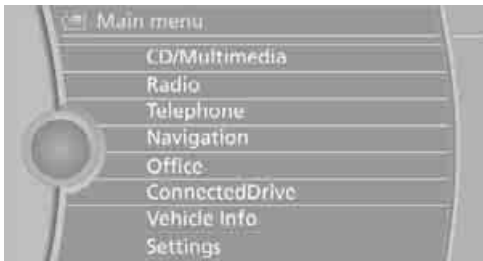

2. "Settings"

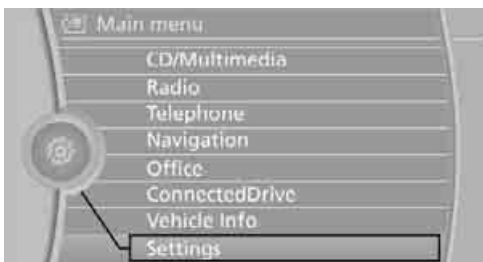

Setting the time

1. "Settings"
2. "Time/Date"

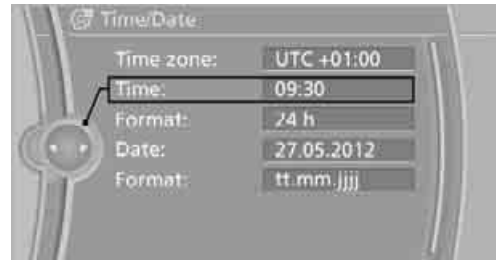

3. "Time:"
4. Turn the controller until the desired hours are displayed, and then press the controller.
5. Turn the controller until the desired minutes are displayed, and then press the controller.

The time is stored.

Setting the time format

1. "Settings"
2. "Time/Date"
3. "Format:"
4. Select the desired format and press the controller.

The time format is stored.

Setting time zone

1. "Settings"
2. "Time/Date"
3. "Time zone:"
4. Select desired time zone.

The time zone is stored.

Date

The settings are stored for the remote control currently in use, refer also to Personal Profile on page 32.

Setting the date

In the instrument cluster

To set the dd/mm or mm/dd date format, refer to Setting the date format below.



1. Push button **1** in the turn signal/high beam lever up or down repeatedly until the appropriate symbol appears in the display, accompanied by the date and the word "SET".
2. Press button **2**.
3. Use button **1** to set the day of the month.
4. Press button **2** to confirm the entry.
5. Set the month and the year in the same way.
6. Press button **2**.
The system stores the new date.

Via iDrive

1. "Settings"
2. "Time/Date"
3. "Date:"
4. Turn the controller until the desired day is displayed, and press the controller.
5. Create the necessary settings for the month and year.

The date is stored.

Setting the date format

1. "Settings"
2. "Time/Date"
3. "Format:"



4. Select the desired format.
The date format is stored.

Check Control

The concept

The Check Control monitors vehicle functions and alerts you to any malfunctions in the systems monitored. Such a Check Control message includes indicator and warning lamps in the instrument cluster and, in some circumstances, an acoustic signal as well as text messages at the top of the Control Display.

Indicator and warning lamps



Indicator and warning lamps can light up in a variety of combinations and colors.

Several of the lamps are checked for proper functioning and light up temporarily when the engine is started or the ignition is switched on.



⚠ indicates that Check Control messages have been stored. These Check Control messages can be viewed again later, refer to page 93.

Text messages

Text messages at the upper edge of the Control Display explain the meaning of the displayed indicator and warning lamps.

Supplemental text messages

You can call up more information on the Control Display, e.g. on the cause of a malfunction and on how to respond, via Check Control.

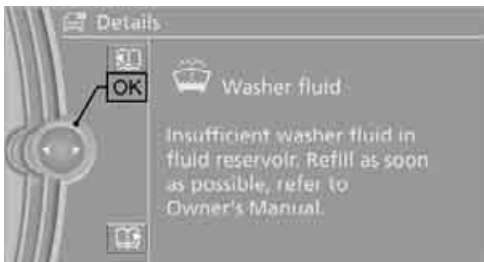

The text of urgent messages is displayed automatically.

To exit the display:
Select "OK" and press the Controller.

Symbols

Depending on the Check Control message, you can select from among the following functions in the supplementary text messages.

- ▷ "Service request"
Contact your BMW center.
- ▷ "Roadside Assistance"
Contact BMW Roadside Assistance.

Hiding Check Control messages

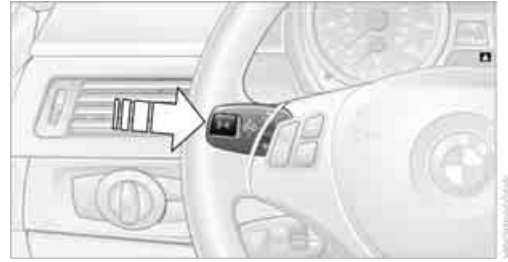

Press the button on the turn signal/high beam lever.

- ▷ Some Check Control messages are displayed continuously and remain visible until the malfunction has been rectified. If several malfunctions occur at once, the messages are displayed consecutively. These messages can be hidden for approx. 8 seconds. After this, they are displayed again automatically.

They are marked with the symbol shown here.

- ▷ Other Check Control messages are hidden automatically after approx. 20 seconds. They are stored and can be displayed again later.

They are marked with the symbol shown here.

Displaying stored Check Control messages



1. Push button **1** in the turn signal/high beam lever up or down repeatedly until the appropriate symbol appears in the display, accompanied by the words "CHECK CONTROL".
2. Press button **2**.
If there are no Check Control messages, then "CHECK OK" is displayed.
If a Check Control message has been stored, the corresponding lamp lights up. It is accompanied by a text message on the Control Display.
3. Push button **1** to check for other messages.
4. Press button **2**.
The display again shows the outside temperature and the time.

Via iDrive

1. "Vehicle Info"
2. "Vehicle status"
3. "Check Control"



4. Select the text message.

Speed limit

You can enter a speed, and a Check Control message will indicate when you reach this speed. This enables you, for example, to receive warnings if you exceed a speed limit in an urban area.

You are only warned of reaching this speed a second time if your vehicle speed falls below it again by at least 3 mph or 5 km/h.

Displaying, setting or changing the limit

1. "Settings"
2. "Speed"
3. "Warning at:"



4. Turn the controller until the desired speed is displayed.
5. Press the controller.
The speed limit is stored.

Applying your current speed as the limit

1. "Settings"
2. "Speed"
3. "Select current speed"

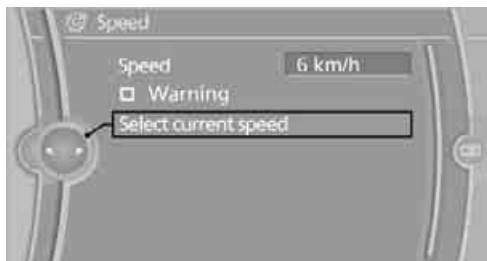

The system adopts your current speed as the limit.

Activating/deactivating the limit

1. "Settings"
2. "Speed"
3. "Warning"

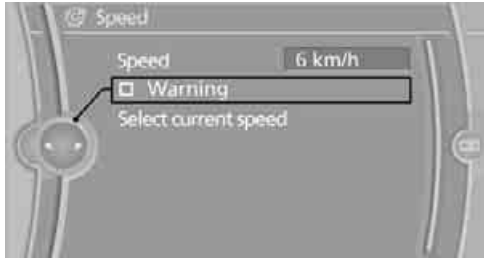

4. Press the controller.

Settings on the Control Display

Language on the Control Display

Setting the language

1. "Settings"
2. "Language/Units"
3. "Language:"

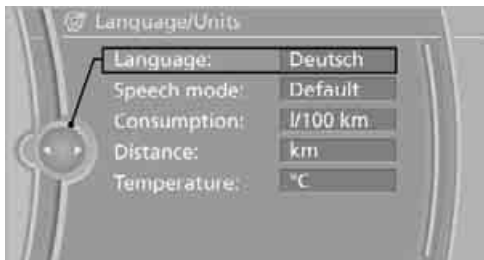

4. Select the desired language.

The setting is stored for the remote control currently in use.

Setting the voice dialog

Switch between a standard dialog and a short dialog.

1. "Settings"
2. "Language/Units"
3. "Speech mode:"
4. Select the desired dialog.



The setting is stored for the remote control currently in use.

Brightness of the Control Display

The brightness is automatically adapted to the ambient lighting conditions. However, you can change the basic setting.

1. "Settings"
2. "Control display"
3. "Brightness"



4. Turn the controller until the desired setting is selected.
5. Press the controller.

The setting is stored for the remote control currently in use. In bright conditions, for example, the brightness control may not be clearly visible.

Technology for driving comfort and safety

Vehicle equipment

In this chapter, all production, country, and optional equipment that is offered in the model range is described. For this reason, descriptions will be given of some equipment that may not be available in a vehicle, for example due to the special options or national-market version selected. This also applies to safety related functions and systems.

Park Distance Control PDC

The concept

The PDC assists you with maneuvering in tight parking spaces. Acoustic signals and a visual indicator warn you of the presence of an object in front of or behind your vehicle. To measure the distance, there are four ultrasonic sensors in either bumper.

These sensors have a range of approx. 6.5 ft/ 2 m. However, an acoustic warning does not sound until an object is approx. 24 in/60 cm from the front sensors and rear corner sensors, or approx. 5 ft/1.50 m from the rear center sensors.



PDC is a parking aid that can indicate objects when they are approached slowly, as is usually the case when parking. Avoid approaching an object at high speed; otherwise, physical circumstances may lead to the system warning being issued too late. ◀

Switching on automatically

With the engine running or the ignition switched on, the system is activated after approx. one second when you shift into reverse or move the automatic transmission selector lever to position R. Wait this short period before driving.

Switching off automatically

After approx. 50 ft/50 m of driving or above approx. 20 mph or 30 km/h, the system switches off and the LED goes out.

Switching on manually

When parking in the forward direction, the sensors must be switched on manually to enable them to signal an approach to an object in front of or behind the vehicle.

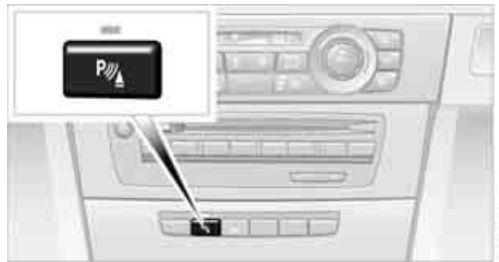

Press the button; the LED lights up.

Switching off manually

Press the button again; the LED goes out.

Signal tones

When nearing an object, its position is indicated correspondingly by an interval tone. For example, if an object is detected behind the vehicle, the signal tone sounds from the rear. As the distance between vehicle and object decreases, the intervals between the tones become shorter. If the distance to the nearest object falls to below roughly 1 ft/30 cm, then a continuous tone sounds.

An interval tone is interrupted after approx. 3 seconds

- ▷ If you remain in front of an object that has been detected by only one of the corner sensors
- ▷ If you are driving parallel to a wall.

Malfuction



The warning lamp lights up. A message appears on the Control Display. PDC is malfunctioning. Have the system checked.

To avoid this problem, keep the sensors clean and free of ice or snow in order to ensure that they will continue to operate effectively. When using a high-pressure cleaner, do not spray the sensors for extended periods of time and only from a distance of at least 1 ft/30 cm.

Manual operation

The LED above the button also flashes.

PDC with visual warning

The approach of the vehicle to an object is shown on the Control Display. Objects that are farther away are displayed on the Control Display before a signal tone sounds. The display appears on the Control Display as soon as PDC is activated.

System limitations



Even with PDC, final responsibility for estimating the distance between the vehicle and any obstructions always remains with the driver. Even when sensors are provided, there is a blind spot in which objects can no longer be detected. The system is also subject to the physical limits that apply to all forms of ultrasonic measurement, such as those encountered with trailer towbars and hitches, thin or wedge-shaped objects, etc. Low objects that have already been displayed, e.g. curbs, can disappear again from the detection area of the sensors before or after a continuous tone sounds. Higher, protruding objects, e.g. ledges, cannot be detected. Therefore, always drive cautiously; otherwise, there is a risk of personal injury or property damage.

Loud sound sources outside or inside the car can drown out the PDC signal. Therefore, always drive cautiously; otherwise, there is a risk of personal injury or property damage. ◀

Driving stability control systems

Your BMW has a number of systems that help to maintain the vehicle's stability even in adverse driving conditions.

ABS Antilock Brake System

ABS prevents locking of the wheels during braking. Safe steering response is maintained even during full braking. Active safety is thus increased.

The ABS is operational every time you start the engine. Braking safely, refer to page 138.

Electronic brake-force distribution EBV

The system controls the brake pressure in the rear wheels to ensure stable braking behavior.

Dynamic Brake Control DBC

When you apply the brakes rapidly, this system automatically produces the maximum braking force boost and thus helps to achieve the shortest possible braking distance during full braking. This system exploits all of the benefits provided by ABS.

Do not reduce the pressure on the brake for the duration of the full braking application.

Dynamic Stability Control DSC

DSC prevents the driving wheels from losing traction when you pull away from rest or accelerate. The system also recognizes unstable driving conditions, for example if the rear of the car is about to swerve or if momentum is acting at an angle past the front wheels. In these cases, DSC helps the vehicle maintain a safe course within physical limits by reducing engine output and through braking actions at the individual wheels.

 The laws of physics cannot be repealed, even with DSC. An appropriate driving style always remains the responsibility of the driver. Therefore, do not reduce the additional safety margin again by taking risks, as this could result in an accident. ◀

Deactivating DSC



Press the button for at least 3 seconds until the indicator lamp for DSC OFF lights up and DSC OFF is displayed in the instrument cluster. Dynamic Traction Control DTC and DSC have been simultaneously deactivated. Stabilizing and drive-output promoting actions are no longer executed.

In the same way as with a differential interlock, even if DSC is deactivated, brake actions are still performed to enhance drive output if the drive wheels experience a significant loss of traction.

To increase vehicle stability, activate DSC again as soon as possible.

Activating DSC

Press the button again; the indicator lamp in the instrument cluster goes out.

For better control



If the indicator lamp flashes: the DSC controls the driving and braking forces.

If the indicator lamp lights up: DSC and DTC have failed.



The indicator lamp lights up and DSC OFF is displayed in the instrument cluster: DSC is deactivated.

Dynamic Traction Control DTC

DTC is a version of DSC in which the drive output is optimized for particular road conditions, e.g. unplowed snow-covered roads. The system assures the maximal drive output, but with reduced driving stability. It is therefore necessary to drive with appropriate caution.

You may find it useful to briefly activate DTC under the following special circumstances:

- ▶ When driving uphill on snow-covered roads, in slush or on unplowed, snow-covered roads
- ▶ When rocking a stuck vehicle free or starting off in deep snow or on loose ground
- ▶ When driving with snow chains

Activating DTC



Press the button; the indicator lamp for DSC OFF lights up and TRACTION is displayed in the instrument cluster.

For better control



If the indicator lamp flashes: DTC controls the driving and braking forces.

If the indicator lamp lights up: DSC and DTC have failed.



The indicator lamp lights up and TRACTION is displayed in the instrument cluster: DTC is activated.

Deactivating DTC

Press the button again; the indicator lamp in the instrument cluster goes out.

xDrive

xDrive is your BMW's four-wheel-drive system. The combined efforts of xDrive and DSC help to further optimize traction and driving dynamics. The xDrive four-wheel-drive system distributes driving power variably to the front and rear axles depending on the driving situation and road conditions.

Hill Descent Control HDC

HDC is a downhill driving assistant that controls your speed on steep downhill gradients and makes it even easier to control your BMW's handling under these conditions. The vehicle then moves slightly faster than double walking speed without the driver needing to intervene.

HDC is available for activation at vehicle speeds below approx. 20 mph or 35 km/h. When driving downhill at a speed of under approx. 20 mph or 35 km/h, the vehicle's speed is automatically reduced to slightly more than double walking speed and maintained.

Increasing or decreasing speed

You can use the accelerator or brakes to vary this automatically controlled speed within a range of between approx. 3 mph/5 km/h and 20 mph/25 km/h.

You can specify a target speed within the same range by using the lever of the cruise control.



- 1 To increase speed
- 2 To decrease speed

Activating HDC



Press the button; the LED lights up. When the vehicle is being braked automatically, the LED flashes.

Deactivating HDC

Press the button again; the LED goes out. HDC is automatically deactivated at speeds over approx. 40 mph or 60 km/h.

Using HDC

In cars with manual transmission:
Use HDC in lower gears and in reverse gear.

With automatic transmission:
You can use HDC in any drive position.

Displays in the instrument cluster



- 1 Display for target speed
- 2 HDC display

Malfunction

The HDC display disappears during HDC operation, or does not appear: HDC is temporarily unavailable due to excessive brake temperature, or DSC has failed.

Drive-off assistant

The drive-off assistant enables you to drive off smoothly on uphill gradients. It is not necessary to use the parking brake for this.

1. Hold the car in place by depressing the brake.
2. Release the brake and drive off without delay.



The drive-off assistant holds the car in place for approx. 2 seconds after the brake is released. Drive off without delay after releasing the brake. Otherwise, the drive-off assistant will no longer hold the car in place after approx. 2 seconds and the car will start to roll backwards. ◀

Flat Tire Monitor FTM

The concept

The system does not measure the actual inflation pressure in the tires.

The system detects a pressure loss in a tire by comparing the rotational speeds of the individual wheels while moving.

In the event of a pressure loss, the diameter and therefore the rotational speed of the corresponding wheel change. This is detected and reported as a flat tire.

Functional requirement

The system must have been initialized while the tire inflation pressure was correct; otherwise, reliable signaling of a flat tire is not ensured.

Each time a tire inflation pressure has been corrected or a wheel or tire has been changed, reinitialize the system.

System limitations



Sudden serious tire damage caused by external influences cannot be indicated in advance. ◀

A natural, steady pressure loss in all four tires is not detected. Therefore, check the tire inflation pressure regularly.

In the following situations, the system could be delayed or malfunction:

- ▷ System has not been initialized
- ▷ Driving on snowy or slippery road surface
- ▷ Performance-oriented style of driving: slip in the drive wheels, high lateral acceleration
- ▷ Snow chains are attached

Status display

The current status of the Flat Tire Monitor can be displayed on the Control Display, e.g. whether or not the FTM is active.

1. "Vehicle Info"
2. "Vehicle status"
3. "Flat Tire Monitor"



The status is displayed.

Initialization

The initialization process adopts the set inflation tire pressures as reference values for the detection of a flat tire. Initialization is started by confirming the inflation pressures.

Do not initialize the system when driving with snow chains.

1. "Vehicle Info"
2. "Vehicle status"
3. "Reset"



4. Start the engine – do not drive away.
5. Start the initialization by selecting "Reset".
6. Start driving.

 The initialization is completed during driving, which can be interrupted at any time. When driving resumes, the initialization is continued automatically. ◀

Indication of a flat tire



The warning lamps light up in yellow and red. A message appears on the Control Display. In addition, an acoustic signal sounds. There is a flat tire or a major loss in tire pressure.

1. Reduce speed and stop the vehicle with caution. Avoid sudden braking and steering maneuvers.

 If the vehicle is not equipped with run-flat tires, do not continue driving; continuing to drive can result in serious accidents. ◀

When a flat tire is reported, the Dynamic Stability Control DSC is activated.

Actions in the event of a flat tire

Run-flat tires

With a damaged tire, it is possible to continue driving at speeds of up to 50 mph/80 km/h.

When driving with a damaged tire:

1. Avoid sudden braking and steering maneuvers.
2. Do not exceed a speed of 50 mph/80 km/h.
3. At the next opportunity, check the inflation pressure in all four tires.

If the inflation pressure in all four tires is correct, the Flat Tire Monitor might not have been initialized. The system must then be initialized.

Possible driving distance with complete loss of tire pressure:

The distance it is possible to drive with a flat tire depends on the load and the stress on the vehicle while driving.

With an average load, it may be possible to drive for approx. 50 miles/80 km.

When driving with damaged tires, the handling characteristics change, e.g. the vehicle will skid sooner when braking, braking distances will be longer, or self-steering response will change. Adapt your driving style accordingly. Avoid turning abruptly and driving over obstacles such as curbs, potholes, etc.

Since the possible driving distance depends to a considerable degree on the strain exerted on the vehicle while driving, it can be shorter or, with a gentle driving style, can also be longer, depending on the speed, road condition, outside temperature, vehicle load, etc.

 Drive cautiously and do not exceed a speed of 50 mph/80 km/h.

When there is a tire pressure loss, the handling characteristics change, e.g. there will be reduced directional stability during braking, braking distances will be longer, and self-steering response will change. ◀

 Vibrations or loud noises while driving can indicate final failure of the tire. Reduce your speed and bring the vehicle to a stop; otherwise, tire components may become detached, which could result in an accident. Do not continue driving; instead, contact your BMW center. ◀

Tire Pressure Monitor TPM

The concept

Check the inflation pressure in the four installed tires. The system notifies you if there is a significant loss of pressure in one or more tires.

Functional requirement

The system must have been reset while the inflation pressure was correct; otherwise, reliable signaling of a flat tire is not ensured. Always use wheels with TPM electronics to ensure that the system will operate properly. Each time a tire inflation pressure has been corrected or a wheel or tire has been changed, reset the system.

System limitations

 Sudden serious tire damage caused by external influences cannot be indicated in advance. ◀

The system does not function correctly if it has not been reset. For example, a flat tire may be indicated even though the tire inflation pressures are correct.

The system is inactive and cannot indicate a flat tire:

- ▷ When a wheel without TPM electronics is installed.
- ▷ Interference with TPM by other systems or devices with the same transmission frequency.

Status display

The current status of the Tire Pressure Monitor TPM can be displayed on the Control Display, e.g., whether or not the TPM is active.

1. "Vehicle Info"
2. "Vehicle status"

3. "Tire Pressure Monitor - TPM"



The status is displayed.

Status indicator on the Control Display

The color of the tires represents the status of the tires and the system.

A change in the tire inflation pressure during driving is taken into account.

A correction is only required when this is indicated by the TPM.

Green wheels

The inflation pressure corresponds to the desired state.

"TPM active" appears in the Control Display.

One wheel yellow

There is a flat tire or substantial loss of tire pressure in the indicated tire.

All wheels yellow

- ▷ There is a flat tire or substantial loss of tire pressure in several tires.
- ▷ The system was not reset after a wheel change and thus issues a warning based on the inflation pressures initialized last.

Gray wheels

The system cannot detect a puncture.

Reasons for this may be:

- ▷ TPM is being reset.
- ▷ Interference from systems or devices that use the same radio frequency.
- ▷ Malfunction.

Resetting the system

Each time a tire inflation pressure has been corrected or a wheel or tire has been changed, reset the system.

1. "Vehicle Info"
2. "Vehicle status"
3. "Reset"



4. Start the engine – do not drive away.
5. Reset the inflation pressure by selecting "Reset".
6. Start driving.

The tires are shown in gray and "Resetting TPM..." is displayed.

After driving a few minutes, the set inflation pressures in the tires are accepted as the target values to be monitored. The resetting process is completed automatically as you drive. The tires are depicted in green on the Control Display and "Status: TPM active" is displayed again.

The trip can be interrupted at any time. When driving resumes, resetting continues automatically.

 If a flat tire is detected while the system is resetting, all tires on the Control Display are displayed in yellow. The message "Low tire!" is displayed. ◀

Message for low tire inflation pressure



The warning lamps light up in yellow and red. A message appears on the Control Display. In addition, a signal sounds.

- ▶ There is a flat tire or substantial loss of tire pressure in the indicated wheel.
- ▶ The system was not reset after a wheel change and thus issues a warning based on the inflation pressures initialized last.

Reduce speed and stop the vehicle with caution. Avoid sudden braking and steering maneuvers.

 If the vehicle is not equipped with run-flat tires, do not continue driving; continuing to drive can result in serious accidents. ◀

When a low tire pressure is reported, the Dynamic Stability Control DSC is activated.

Actions in the event of a flat tire

Run-flat tires

You can continue driving with a damaged tire at speeds up to 50 mph/80 km/h.

When driving with a damaged tire:

1. Avoid sudden braking and steering maneuvers.
2. Do not exceed a speed of 50 mph/80 km/h.
3. At the next opportunity, check the inflation pressure in all four tires.

If the inflation pressure is correct in all four tires, then the Tire Pressure Monitor may not have been reset. The system must then be reset.

Possible driving distance with complete loss of tire inflation pressure:

The distance it is possible to drive with a flat tire depends on the load and the stress on the vehicle while driving.

With an average load, it may be possible to drive for approx. 50 miles/80 km.

When driving with damaged tires, the handling characteristics change, e.g. the vehicle will skid sooner when braking, braking distances will be longer, or self-steering response will change. Adapt your driving style accordingly. Avoid turning abruptly and driving over obstacles such as curbs, potholes, etc.

Since the possible driving distance depends to a considerable degree on the strain exerted on the vehicle while driving, it can be shorter or, with a gentle driving style, can also be longer, depending on the speed, road condition, outside temperature, vehicle load, etc.

 Drive cautiously and do not exceed a speed of 50 mph/80 km/h.

When there is a tire pressure loss, the handling characteristics change, e.g. there will be reduced directional stability during braking, braking distances will be longer, and self-steering response will change. ◀

 Vibrations or loud noises while driving can indicate complete failure of the tire.

Reduce your speed and bring the vehicle to a stop; otherwise, tire components may become detached, which could result in an accident. Do not continue driving; instead, contact your BMW center. ◀

Message for unsuccessful system reset

 Yellow warning lamp lights up. A message appears on the Control Display.

The system has detected a wheel change, but was not reset. A reliable warning is not possible at the current inflation pressures.

Check the tire inflation pressure and reset the system, refer to page 103.

Malfunction



The small warning lamp flashes in yellow and then lights up continuously; the large warning lamp lights up in yellow. The tires appear in gray in the Control Display. No punctures can be detected.

Display in the following situations:

- ▷ A wheel without TPM electronics has been installed:
Have it checked by your BMW center.
- ▷ Malfunction
Have the system checked.
- ▷ Tire Pressure Monitor was unable to complete the resetting process. Reset the system again.



The small warning lamp flashes in yellow and then lights up continuously; the large warning lamp lights up in yellow. The tires appear in gray in the Control Display. No punctures can be detected.

Display in the following situations:

- ▷ Interference from systems or devices that use the same radio frequency:
The system automatically becomes active again when the vehicle moves out of the interference zone.

Declaration according to NHTSA/ FMVSS 138

Tire Pressure Monitoring Systems

Each tire should be checked monthly when cold and inflated to the inflation pressure recommended by the vehicle manufacturer on the vehicle placard or tire inflation pressure label. If your vehicle has tires of a different size than the size indicated on the vehicle placard or tire inflation pressure label, you should determine the proper tire inflation pressure for those tires. As an added safety feature, your vehicle has been equipped with a tire pressure monitoring system, TPMS, that illuminates a low tire pressure telltale when one or more of your tires are signif-

icantly underinflated. Accordingly, when the low tire pressure telltale illuminates, you should stop and check your tires as soon as possible, and inflate them to the proper pressure. Driving on a significantly underinflated tire causes the tire to overheat and can lead to tire failure.

Underinflation also reduces fuel efficiency and tire tread life and may affect the vehicle's handling and stopping ability. Please note that the TPMS is not a substitute for proper tire maintenance, and it is the driver's responsibility to maintain correct tire pressure, even if underinflation has not reached the level to trigger illumination of the TPMS low tire pressure indicator.

The TPMS malfunction indicator is combined with the low tire pressure telltale. When the system detects a malfunction, the telltale will flash for approximately one minute and then remain continuously lit. This sequence will continue upon subsequent vehicle startups as long as the malfunction exists. When the malfunction indicator is illuminated, the system may not be able to detect or signal low tire pressure as intended. TPMS malfunctions may occur for a variety of reasons, including the installation of replacement or alternate tires or wheels on the vehicle that prevent the TPMS from functioning properly. Always check the TPMS malfunction telltale after replacing one or more tires or wheels on your vehicle to ensure that the replacement or alternate tires and wheels allow the TPMS to continue to function properly.

Active steering

The concept

Active steering varies the turning angle of the front wheels in relation to steering wheel movements. It also varies the steering force required to turn the wheels depending on the speed at which you are driving.

When you are driving in the low speed range, e.g. in a town or when parking, the steering angle is increased, i.e. steering becomes very direct and less effort is required to turn the wheels. In the higher speed range, on the other hand, the steering angle is reduced as the speed increases. This improves the handling of your BMW over the entire speed range.

In critical situations, the system can make targeted corrections to the steering angle provided by the driver and thus stabilize the vehicle before the driver intervenes. This stabilizing intervention is simultaneously deactivated when DSC is switched off, refer to page 98.

Malfunction



The warning lamps light up and a message is displayed on the Control Display. Active steering is malfunctioning or is temporarily deactivated.

At low speeds, greater steering wheel movements are required, whereas at higher speeds the vehicle reacts more sensitively to steering wheel movements. The stability-enhancing feature may also be deactivated. Drive cautiously and think well ahead.

Deactivation

Active steering is deactivated to perform an initialization. A message indicates that the feature is deactivated. Initialization may take several minutes.

If the message does not disappear during the current trip, have the system checked.

Defect

If there is a defect, a corresponding text message appears. Have the system checked.

Servotronic

The concept

The Servotronic varies the steering force required to turn the wheels relative to the vehicle speed.

At low speeds, the steering force is strongly assisted, i.e. less force is needed for steering. As the vehicle speed increases, the steering assisting power is reduced.

Malfunction



The warning lamp lights up. A message appears on the Control Display.

Servotronic is malfunctioning or has failed. Steering response will be different. You can continue your journey, but moderate your speed and exercise due caution. Have the system checked as soon as possible.

Brake Force Display



On the left: normal braking.

On the right: sharp braking.

Airbags



The following airbags are located under the marked covers:

- 1 Front airbags
- 2 Coupe: head airbags
- 3 Side airbags in the seat backrests
- 4 Convertible: knee airbags

Protective action

 Observe the adjustment instructions on page 48 to ensure the best possible personal protection. ◀

The front airbags help protect the driver and front passenger by responding to frontal impacts in which safety belts alone cannot provide adequate restraint. When needed, the head and side airbags help provide protection in the event of side impact. The relevant side airbag supports the side upper body area. The head air bag supports the head.

The airbags have been designed to not be triggered in every collision situation, e.g. not in minor accidents or rear-end collisions.

 Do not apply adhesive materials to the cover panels of the airbags, cover them or modify them in any other way.

Keep the dashboard and windows on the front passenger side clear, i.e. do not cover with adhesive labels or coverings, and do not attach holders such as for navigation instruments or mobile phones.

Do not attach seat covers, cushions or other objects not specifically approved for seats with

integral side airbags to the front seats. Do not hang items of clothing such as coats or jackets over the backrests. Do not attempt to remove the airbag retention system from the vehicle. Do not modify the individual components of the system or its wiring in any way. This includes the upholstered covers on the steering wheel, instrument panel, seats and roof posts, as well as the sides of the roof lining. Do not attempt to remove or dismantle the steering wheel.

Do not touch the individual components immediately after the system has been triggered, because there is a danger of burns.

In the event of faults, immobilization, or after the airbag system has been triggered, have the testing, repair, or disassembly and scrapping of gas generators performed only by your BMW center or a workshop that has the required explosives licenses. Unprofessional attempts to work on the system could lead to failure in an emergency or to undesired airbag activation, either of which could result in personal injury. ◀

Warning notices and information about the airbags can also be found on the sun visors.

Automatic deactivation of the front passenger airbags

An analysis of the impression in the front passenger seat cushion determines whether and how the seat is occupied. The front and side airbags for the front passenger are activated or deactivated by the system accordingly.

 The indicator lamp above the interior rearview mirror shows the current status of the front passenger airbags, deactivated or activated, refer to Status of front passenger airbags below. ◀

 Before transporting a child on the front passenger seat, read the safety precautions and handling instructions under Transporting children safely, refer to page 58. The front and side airbags can also be deactivated by adolescents and adults sitting in certain positions; the indicator lamp for the front passenger airbags lights up. In such cases, the passenger should change his or her sitting position so that the front passenger airbags are activated and the indicator lamp goes out. If the desired airbag status cannot be achieved by changing the sitting position, transport the relevant passenger on a rear seat. Do not attach seat covers, seat cushion padding, ball mats or other items to the front passenger seat unless they are specifically recommended by BMW. Do not place any items under the seat which could press against the seat from below. Otherwise, a correct analysis of the seat cushion is not ensured. ◀

Status of front passenger airbags



The indicator lamp for the front passenger airbags shows the functional status of the front passenger front and side airbags in accordance with whether and how the front passenger seat is occupied. The indicator lamp shows whether the front passenger airbags are activated or deactivated.

▷ The indicator lamp lights up when a child in a specially designated child restraint system is detected, as intended, on the seat. The front and side airbags for the front passenger are not activated.

 Most child seats are detected by the system. This particularly applies to child seats that were required by NHTSA at the time of manufacture of the vehicle. After mounting a child seat, ensure that the indicator lamp for the front passenger airbag is lit. It indicates that the child seat has been detected and that the front passenger airbags are deactivated. ◀

- ▷ The indicator lamp does not light up as long as a person of sufficient size and in a correct sitting position is detected on the seat. The front and side airbags for the front passenger are activated.
- ▷ The indicator lamp does not light up if the seat is empty. The front and side airbags for the front passenger are not activated.

Operational readiness of airbag system



As of radio readiness, refer to page 62, the warning lamp lights up briefly to indicate that the entire airbag system and the belt tensioners are operational.

Airbag system malfunction

- ▷ Warning lamp does not light up at radio readiness or beyond.
- ▷ Warning lamp remains permanently on.

! In the event of a fault in the airbag system, have it checked without delay; otherwise, there is the risk that the system will not function as intended even if a sufficiently severe accident occurs. ◀

Convertible: rollover protection system

The rollover protection system is activated automatically in the event of an accident of sufficient severity or an extreme tilt in the car's longitudinal axis. The protection bars behind the rear head restraints deploy within fractions of a second.

As a supplementary system to the reinforced windshield frame, the rollover protection system increases the safety of the vehicle occupants.

! Always keep the area of movement of the rollover protection system clear. In minor accidents, you are protected by the fastened safety belt and, depending on accident severity, by the safety belt tensioner and multi-phase airbag retention system. ◀

Resetting

If the rollover protection system was not impacted after being automatically activated, it can be reset by lowering the protection bars to their original positions. This does not require tools.

1. Push the locking lever to one side and hold it there.

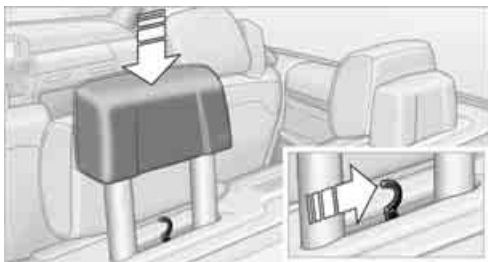

2. Push the protection bar halfway down from above.
3. Release the locking lever.
4. Push the protection bar down until it snaps into place.

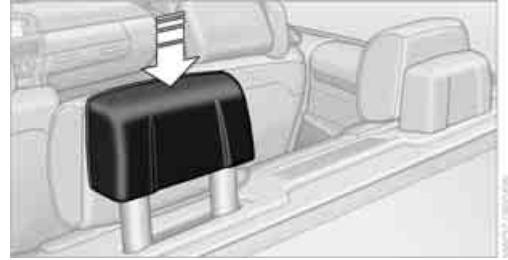

5. Repeat the procedure for the other protection bar.

Have the rollover protection system checked after an unexpected activation.

! Never move the retractable hardtop when the rollover protection system is in the activated position.

Do not make any modifications to the individual components of the rollover protection system or its cabling.

Work on the rollover protection system should be performed only by your BMW center. Incorrectly performed work on the system may lead to system failure or incorrect operation. To check the system and ensure flawless long-term operation, always observe the service intervals, refer to page 88. ◀

Lamps

Vehicle equipment

In this chapter, all production, country, and optional equipment that is offered in the model range is described. For this reason, descriptions will be given of some equipment that may not be available in a vehicle, for example due to the special options or national-market version selected. This also applies to safety related functions and systems.

At a glance

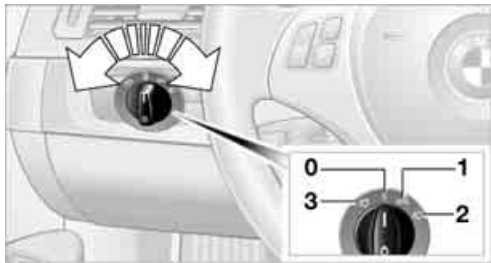

- 0** Lamps off, daytime running lights
- 1** Parking lamps and daytime running lights
- 2** Low beams, welcome lamps
- 3** Automatic headlamp control, daytime running lights, welcome lamps, High-beam Assistant, and Adaptive Light Control

Parking lamps/low beams, automatic headlamp control

General information

When the driver's door is opened with ignition switched off, then the exterior lighting is automatically switched off if the light switch is in position **0**, **2**, or **3**.

Parking lamps

In switch position **1**, the front, rear and side vehicle lighting is switched on. You can use the parking lamps for parking.



The parking lamps will discharge the battery. Therefore, do not leave them on for unduly long periods of time; otherwise, the battery might not have enough power to start the engine. It is preferable to switch on the left-hand or right-hand roadside parking lamps, refer to page [112](#). ◀

Low beams

The low beams light up when the light switch is in position **2** and the ignition is on.

Automatic headlamp control

When the switch is in position **3**, the low beams are switched on and off automatically depending on ambient lighting conditions, e.g. in a tunnel, in twilight, or if there is precipitation. The Adaptive Light Control is active. The LED next to the symbol is illuminated when the low beams are on. You can also activate the daytime running lights, refer to page [111](#). In the situations described above, the lamps then automatically switch from daytime running lights to low beams.

The headlamps may also come on when the sun is sitting low on a blue sky.



The low beams remain switched on independent of the ambient lighting conditions when you switch on the fog lamps. ◀



The automatic headlamp control cannot serve as a substitute for your personal judgment in determining when the lamps should be switched on in response to ambient lighting conditions. For example, the system cannot detect fog or hazy weather. To avoid safety risks, you should always switch on the low-beam headlamps manually under these conditions. ◀

Welcome lamps

If you leave the light switch in position **2** or **3** when you park the car, the parking lamps and the interior lamps light up briefly when you unlock the vehicle.

Activating/deactivating welcome lamps

1. "Settings"
2. "Lighting"
3. "Welcome light"



The setting is stored for the remote control currently in use.

Pathway lighting

If the headlamp flasher is activated after switching off the ignition with the lamps switched off, the low beams come on and remain on for a certain time.

Setting duration

1. "Settings"
2. "Lighting"
3. "Pathway light.:"
4. Set a time of duration or deactivate the function.



The setting is stored for the remote control currently in use.

Daytime running lights

The daytime running lights light up in switch position **0**, **1** and **3**. They are less powerful than the low beams.

The tail lamps may also light up.

Activating/deactivating daytime running lights

1. "Settings"
2. "Lighting"
3. "Daytime running lamps"

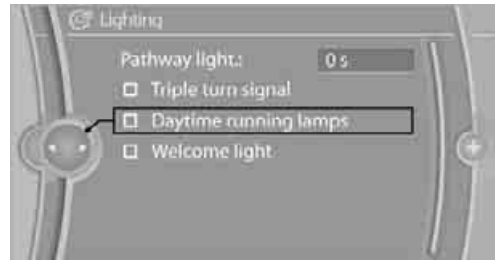

The setting is stored for the remote control currently in use.

Adaptive Light Control

The concept

Adaptive Light Control is a variable headlamp control system that enables better illumination of the road surface. Depending on the steering angle and other parameters, the light from the headlamp follows the course of the road.

In tight curves at speeds up to 40 mph/70 km/h, e.g. on mountainous roads or when turning, an additional, corner-illuminating lamp is switched on that lights up the inside area of the curve.

Activating Adaptive Light Control

With the ignition switched on, turn the light switch to position **3**, refer to page [110](#).

The corner-illuminating lamp is switched on automatically, depending on the steering wheel angle or turn signal indicator.

Standstill function: to avoid blinding oncoming traffic, the Adaptive Light Control does not direct light toward the driver's side when the vehicle is at a standstill.

When you are reversing, only the corner-illuminating lamps are switched on and active on both sides.

Malfunction



The warning lamp lights up. A message appears on the Control Display. The Adaptive Light Control is malfunctioning or failed. Have the system checked as soon as possible.

High beams/roadside parking lamps

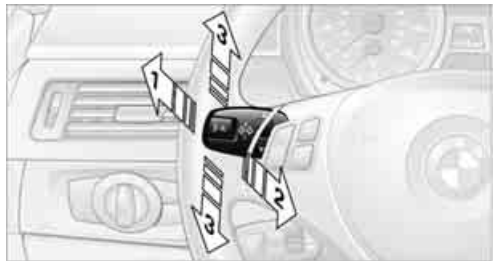

- 1 High beams
- 2 Headlamp flasher
- 3 Roadside parking lamps

Roadside parking lamps, left or right

There is an additional option of switching on the lamps on the side of the car facing the road when parked.

Switching on

After parking the vehicle, press the lever up or down beyond the pressure point for a longer period, arrow **3**.



The roadside parking lamps drain the battery. Therefore, do not leave them on for unduly long periods of time; otherwise, the battery might not have enough power to start the engine. ◀

Switching off

Press the lever in the opposite direction to the pressure point, arrow **3**.

High-beam Assistant

The concept

This system automatically switches the high beams on and off. The procedure is controlled by a sensor on the front of the interior rearview mirror. The assistant ensures that the high beams are switched on whenever the traffic situation allows. It handles this task for you and gives you the benefit of the best possible view. You can intervene at any time and switch the high beams on and off as usual.

Activating the system

1. Turn the light switch to position **3**, refer to page 110.
2. With the low beams switched on, briefly push the turn signal/high beam lever in the direction of the high beam.



The indicator lamp in the instrument cluster lights up when the high beams are activated. The system automatically switches from high beams to low beams and vice versa in response to oncoming traffic, traffic ahead of you, and adequate ambient lighting, e.g. on city streets.

Switching the high beams on and off manually

Whenever you wish, or when the situation requires, you can intervene:

- ▷ If the High-beam Assistant switches on the high beams, but you would like to drive with the low beams, simply switch off the high

beams using the turn signal/high beam lever. This deactivates the High-beam Assistant.

To reactivate the system, briefly push the turn signal/high beam lever toward the high beams again.

- ▶ If the High-beam Assistant switches on the low beams, but you would like to drive with the high beams, switch on the high beams as usual. This deactivates the system and the high beams need to be switched off manually, if necessary.

To reactivate the system, briefly push the turn signal/high beam lever toward the high beams again.

- ▶ Use the headlamp flasher as usual with the low beams switched on.

System limitations

 The High-beam Assistant cannot serve as a substitute for the driver's personal judgment of when to use the high beams. Therefore, manually switch off the high beams in situations where this is required to avoid a safety risk. ◀

The system is not fully functional in situations such as the following, and driver intervention may be necessary:

- ▶ In very unfavorable weather conditions, such as fog or heavy precipitation
- ▶ In detecting poorly-lit road users, such as pedestrians, cyclists, horseback riders and wagons; when driving close to train or ship traffic; and at animal crossings
- ▶ In tight curves, on hilltops or in depressions, in cross traffic or half-observed oncoming traffic on highways
- ▶ In poorly lit towns and cities and in the presence of highly reflective signs
- ▶ At low speeds
- ▶ When the windshield in front of the interior rearview mirror is fogged over, dirty or covered with stickers, etc.

- ▶ If the sensor is dirty. Clean the sensor on the front of the interior rearview mirror using a cloth moistened with a small amount of glass cleaner.

Activating via iDrive

1. "Settings"
2. "Lighting"
3. "High beam assistant"

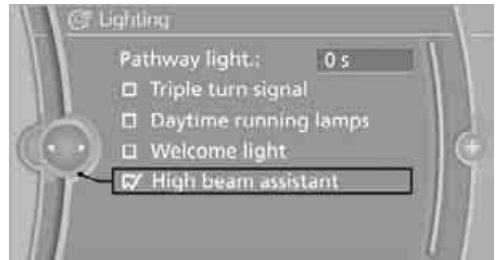

The setting is stored for the remote control currently in use.

Fog lamps



 The parking lamps or low beams must be switched on for the fog lamps to operate. The green indicator lamp in the instrument cluster lights up whenever the fog lamps are on.

The fog lamps are switched off while you activate the headlamp flasher or switch on the high beams.

- ▶ If the automatic headlamp control is activated, the low beams will come on automatically when you switch on the fog lamps. ◀

Instrument lighting

You can adjust the brightness of the instrument lighting only when the parking lamps or the low beams are switched on.



1. Push button **1** up or down repeatedly until the appropriate symbol appears in the display, accompanied by the brightness setting and scale the word "SET".
2. Press button **2**.



3. Push button **1** up or down to select the desired brightness level.
4. Press button **2**.
The display again shows the outside temperature and the time.

Interior lamps

The interior lamps, the footwell lamps, entry lamps, trunk lamp, and courtesy lamps are controlled automatically.

The LEDs for the courtesy lamps are set in the door handles and illuminate the ground in front of the doors.

 To reduce the drain on the battery, a few minutes after the radio readiness is switched off, refer to Start/Stop button on page 62, all lights in the vehicle's passenger compartment are switched off. ◀

Switching interior lamps on/off manually



Interior lamps, front and rear:
To switch on and off, press the button.

To switch off the interior lamps, footwell lamps, entry lamps, and courtesy lamps permanently, press the button for the front interior lamps for about 3 seconds.

Reading lamps

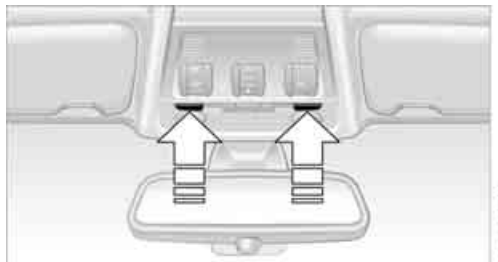

There are reading lamps at the front and rear, next to the interior lights. To switch on and off, press the button.

Climate

Vehicle equipment

In this chapter, all production, country, and optional equipment that is offered in the model range is described. For this reason, descrip-

tions will be given of some equipment that may not be available in a vehicle, for example due to the special options or national-market version selected. This also applies to safety related functions and systems.

Overview



- | | | | |
|---|--|---|--------------------------|
| 1 | Airflow directed toward the windshield and side windows | 4 | Air distribution, manual |
| 2 | Air to the upper body area
Draft-free ventilation 118 | 5 | Temperature, left side |
| 3 | Air to the footwell | 6 | Maximum cooling |
| | | 7 | AUTO program |

- 8** Air volume, manual adjustment; AUTO intensity
- 9** Automatic recirculated air control AUC/ Recirculated air mode
- 10** Temperature, right side
- 11** ALL program
- 12** Defrosting windows and removing condensation
- 13** Switching air conditioning on/off manually
- 14** Rear window defroster
- 15** Seat heating, right side **53**
- 16** Interior temperature sensor, please keep clear
- 17** Seat heating, left side **53**

Automatic climate control

Comfortable interior climate

AUTO program **7** offers the ideal air distribution and air volume for almost all conditions, refer to AUTO program below. All you need to do is select an interior temperature which is comfortable for you.

The following sections inform you in detail about how to adjust the settings.

Most settings are stored for the remote control currently in use, refer also to Personal Profile settings on page **33**.

Adjusting air distribution manually



The air distribution can be switched on and off manually. The air is directed to the windshield, to the upper body area and to the

footwell.

The automatic air distribution can be switched back on by pressing the AUTO button. The air conditioning is switched on automatically and the manual air distribution setting is cleared.

Temperature



Turn to set the desired temperature.

The automatic climate control achieves this temperature as quickly as possible regardless of the season, using maximum cooling or heating power if necessary, and then maintains it.

Avoid rapid switching between different temperature settings. The automatic climate control will not have sufficient time to adjust the set temperature.

Maximum heating power can be obtained with the highest setting, regardless of the outside temperature.

The system cools steadily in the lowest setting, regardless of the outside temperature.

Maximum cooling



Press the button.

The system is set to the lowest temperature, maximum air volume and recirculated air mode.

Air flows out of the vent outlets for the upper body region. Open them for this purpose.

Air is cooled as quickly as possible:

- ▷ Above an outside temperature of approx. 32 °F / 0 °C
- ▷ When the engine is running

AUTO program



Press the button.

Air volume, air distribution and temperature are controlled automatically.

Depending on the selected temperature, AUTO intensity and outside influences, the air is directed toward the windshield, the side windows, the upper body and the footwell.

Pressing the AUTO button automatically switches on the air conditioning.

At the same time, a condensation sensor controls the program so as to prevent window condensation as much as possible.

The program is switched off when the air distribution is set manually or the button is pressed again.

Intensity of the AUTO program

With the AUTO program switched on, automatic control of the air volume and air distribution can be adjusted:



Press the left side of the button to reduce the intensity. Press the right side of the button to increase it.

The selected intensity is shown on the display of the automatic climate control.

Convertible program

The Convertible program is active when the hardtop is open and the AUTO program is switched on. In the Convertible program, the automatic climate control is optimized for driving with the hardtop open. In addition, the air volume is increased as vehicle speed increases.



The effectiveness of the Convertible program can be enhanced considerably by installing the wind deflector. ◀

Adjusting air volume manually

To be able to manually adjust the air volume, switch off the AUTO program first.



Press the left side of the button to reduce the air volume. Press the right side of the button to

increase it.

The air flow rate is lowered or switched off entirely to reduce the drain on the battery. The display remains the same.

Automatic recirculated air control AUC/Recirculated air mode

You can respond to unpleasant odors or pollutants in the immediate environment by temporarily suspending the supply of outside air. The system then recirculates the air currently within the vehicle.



Press the button repeatedly to select an operating mode:

- ▷ LED off: outside air flows in continuously.
- ▷ Left-hand LED on, AUC mode: a sensor detects pollutants in the outside air and controls the shut-off automatically.
- ▷ Right-hand LED on, recirculated air mode: the supply of outside air is permanently shut off. If the windows fog over, switch off recirculated air mode and increase the air volume, if necessary. Make sure that air can flow onto the windshield.



The recirculated air mode should not be used over an extended period of time; otherwise, the air quality inside the car will deteriorate continuously. ◀

Via the button on the steering wheel

You can switch quickly between the recirculated air mode and the previous mode using a button on the steering wheel, refer to page 13.

ALL program



Press the button.

The current temperature setting on the driver's side is transferred to the front passenger side.

If the temperature setting on the driver's side is changed, the temperature on the front passenger side is changed as well.

The program is switched off when the setting is adjusted on the front passenger side or the button is pressed again.

Defrosting windows and removing condensation



Press the button.

Quickly removes ice and condensation from the windshield and

front side windows.

For this purpose, also switch on the air conditioning.

Switching air conditioning on/off

The passenger compartment can only be cooled while the engine is running.



Press the button.

The air is cooled and dehumidified and – depending on the temperature setting – warmed again.

Depending on the weather, the windshield may fog up briefly when the engine is started.

Pressing the AUTO button automatically switches on the air conditioning.

Rear window defroster



Press the button.

The defroster is switched off automatically after a certain time.

Depending on your vehicle's equipment, the upper wires serve as an antenna and are not part of the rear window defroster.

Switching the system on/off

Switching off



Press and hold the left button or press the left button at the lowest level.

All displays are cleared except for the rear window defroster if it is switched on.



The outside air supply is blocked when the automatic climate control is switched off. If the air quality deteriorates or the window fogs over, switch the system back on and increase the air volume. ◀

Switching on

Press any button, except the buttons for the ALL program or the rear window defroster.

Ventilation



- 1 Use the thumbwheels to smoothly open and close the air vents
- 2 Use the levers to change the direction of the airflow
- 3 Thumbwheel for more or less cool air from the vents for the upper body area

Ventilation for cooling

Adjust the vent outlets to direct the flow of cool air in your direction, e.g. if it has become too hot in the car.

Draft-free ventilation

Set the vent outlets so that the air flows past you and not straight at you.

Ventilation in the rear

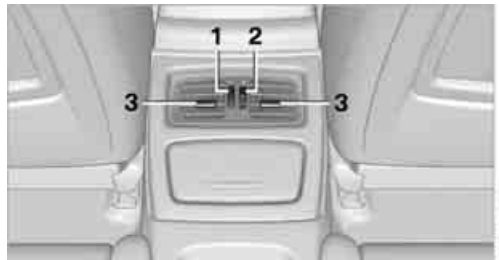

- 1 Use the thumbwheel to adjust the temperature:
 - ▷ Turn toward blue: colder
 - ▷ Turn toward red: warmer

- 2 Use the thumbwheel to smoothly open and close the air vents
- 3 Use the lever to change the direction of the airflow

Microfilter/activated-charcoal filter

The microfilter traps dust and pollen in the incoming air. The activated-charcoal filter provides additional protection by filtering gaseous pollutants from the outside air. Your BMW center replaces this combined filter during routine maintenance.

Parked car ventilation

The concept

The parked car ventilation provides ventilation to the passenger compartment and lowers its temperature, if necessary.

For any outside temperature, the system can be switched on or off directly or via a preset switch-on time. It will remain on for 30 minutes.

Due to its high power consumption, the parked car ventilation system should not be switched on twice in a row without driving in between to allow the battery to recharge.

Open the vents so that air can flow out.

They can be operated via iDrive.

Switching on/off directly

1. "Settings"
2. "Climate"
3. "Activate parked-car vent."

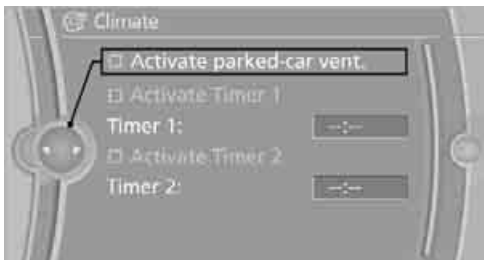

☞ The symbol on the automatic climate Control Display flashes.

Preselecting switch-on times

1. "Settings"
2. "Climate"
3. "Activate Timer 1" or "Activate Timer 2".
4. "Timer 1:" or "Timer 2:"

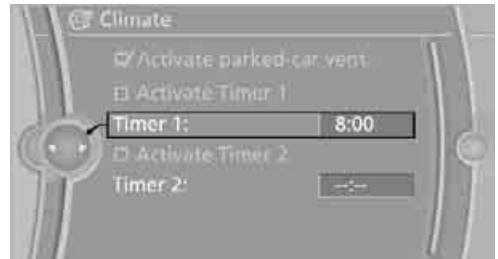

5. Turn the controller: set the hours.
6. Press the controller: the setting is accepted.
7. Turn the controller: set the minutes.
8. Press the controller: the setting is accepted.

☞ The symbol on the automatic climate Control Display lights up.

☞ The symbol on the automatic climate Control Display flashes when the system has switched on.

▶ The respective system is switched on within the next 24 hours only. After these have elapsed, it must be reactivated. ◀

Practical interior accessories

Vehicle equipment

In this chapter, all production, country, and optional equipment that is offered in the model range is described. For this reason, descriptions will be given of some equipment that may not be available in a vehicle, for example due to the special options or national-market version selected. This also applies to safety related functions and systems.

Integrated universal remote control

The concept

The Integrated universal remote control can be used to operate up to 3 functions of remote-controlled devices such as garage door openers or lighting systems. The Integrated universal remote control thus replaces as many as three different hand-held transmitters. To operate them, the buttons on the interior rearview mirror must be programmed with the desired functions. Programming requires the hand-held transmitter for the respective device.

 To prevent possible damage or injury, before programming or using the integrated universal remote control to operate a device, always inspect the immediate area to make certain that no people, animals or objects are within the pivoting or travel range of the device being operated.

Also follow the safety instructions supplied with the hand-held transmitter. ◀

For security reasons, make sure to delete the stored functions before selling the vehicle, refer to page 122.

Compatibility



If this symbol appears on the package or in the instructions supplied with the device to be operated, you can generally assume that the device is compatible with the Integrated universal remote control.

For additional questions, please consult:

- ▷ Your BMW center.
- ▷ www.homelink.com on the Internet.

HomeLink is a registered trademark of Johnson Controls, Inc.

Controls on the interior rearview mirror

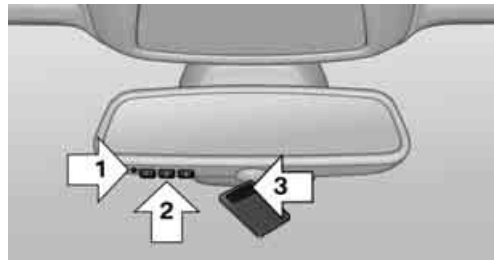

- 1 LED
- 2 Buttons
- 3 Hand-held transmitter, required for programming.

Programming

General information

1. Switch on the ignition.
2. Initial operation:
Simultaneously hold down the right and left buttons on the inside mirror for approx. 20 seconds until the LED on the inside mirror flashes.

All programs of the buttons on the rearview mirror are deleted.

3. Hold the hand-held transmitter of the device to be controlled approx. 1 in/2.5 cm to 3 in/8 cm away from the buttons on the inside mirror.

The required distance depends on the hand-held transmitter.

4. Simultaneously press and hold the button of the desired function on the hand-held transmitter and the button to be programmed on the inside mirror.

The LED on the inside mirror will flash slowly at first.

5. As soon as the LED flashes rapidly, release both buttons. The rapid flashing indicates that the button on the inside mirror has been programmed.

If the LED does not flash rapidly within 60 seconds, change the distance between the inside mirror and the hand-held transmitter and repeat this step. This may require several attempts. Allow at least 15 seconds between attempts.

6. To program additional functions on the other buttons of the inside mirror, repeat steps 3 through 5.

The buttons on the inside mirror can be used to operate the devices if the ignition is switched on.

Special procedure with alternating-code systems

If the device fails to function even after repeated programming, check whether the device to be controlled uses an alternating-code system.

To do so, either read the instructions for the device or hold down the programmed button on the inside mirror. If the LED on the inside mirror flashes quickly at first and then remains lit for 2 seconds, the device uses an alternating-code system. The LED flashes and lights up repeatedly for approx. 20 seconds.

In devices with an alternating-code system, the Integrated universal remote control and the device must also be synchronized.

For information about synchronizing can also be found in the operating instructions for the device to be set.

Programming will be easier with the aid of a second person.

Synchronizing:

1. Park your vehicle within the range of the remote-controlled device.
2. Program the Integrated universal remote control as described above.
3. Locate and press the synchronization button on the device to be set. You have approx. 30 seconds to perform the next step.
4. Hold down the programmed button on the inside mirror for approx. 3 seconds and then release it. Repeat this operation, up to three times if necessary, to complete the synchronization. If the synchronization has succeeded, the programmed function is performed.

Reprogramming individual buttons

1. Switch on the ignition.
2. Hold the hand-held transmitter of the device to be controlled approx. 1 in/2.5 cm to 3 in/8 cm away from the buttons on the inside mirror.

The required distance depends on the hand-held transmitter.

3. Press the desired button on the inside mirror.
4. If the LED on the inside mirror flashes slowly after approx. 20 seconds, press the transmit key of the hand-held transmitter.
5. As soon as the LED flashes rapidly, release both buttons.

If the LED does not flash rapidly after approx. 60 seconds, alter the distance and repeat the step.

Canada: if the LED does not flash rapidly after approx. 60 seconds, alter the distance and repeat this step or, if the programming by means of the hand-held transmitter was interrupted, hold down the button on the inside mirror and then press and release the button on the hand-held transmitter several times, holding it down for 2 seconds each time.

Operation

 To prevent possible damage or injury, before programming or using the integrated universal remote control to operate a device, always inspect the immediate area to make certain that no people, animals or objects are within the pivoting or travel range of the device being operated.

Also follow the safety instructions supplied with the hand-held transmitter. ◀

The button on the inside mirror can be used to operate the device, for example the garage door, if the engine is running or the ignition is switched on. To do so, within the reception range of the device, press the button of the device until the function is triggered. The LED on the inside mirror remains lit during transmission of the radio signal.

Deleting stored functions

Simultaneously hold down the right and left buttons on the inside mirror for approx. 20 seconds until the LED on the inside mirror flashes rapidly. All stored functions are deleted. The functions cannot be deleted individually.

Digital compass

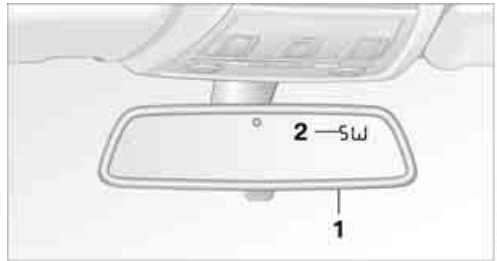

- 1 Adjustment button
- 2 Display

The display shows you the main or secondary compass direction in which you are driving.

Operating principle

You can call up various functions by pressing the adjustment button with a pointed object such as a pen or similar item. The following adjustment options are displayed one after the other, depending on how long you keep the adjustment button pressed:

- ▷ Press briefly: switch display on/off
- ▷ 3 to 6 seconds: set compass zone
- ▷ 6 to 9 seconds: calibrate compass
- ▷ 9 to 12 seconds: set left-hand/right-hand steering
- ▷ 12 to 15 seconds: setting the language

Setting compass zones

Set the compass zone corresponding to your vehicle's geographic location so that the compass can function correctly; refer to the world map with compass zones.

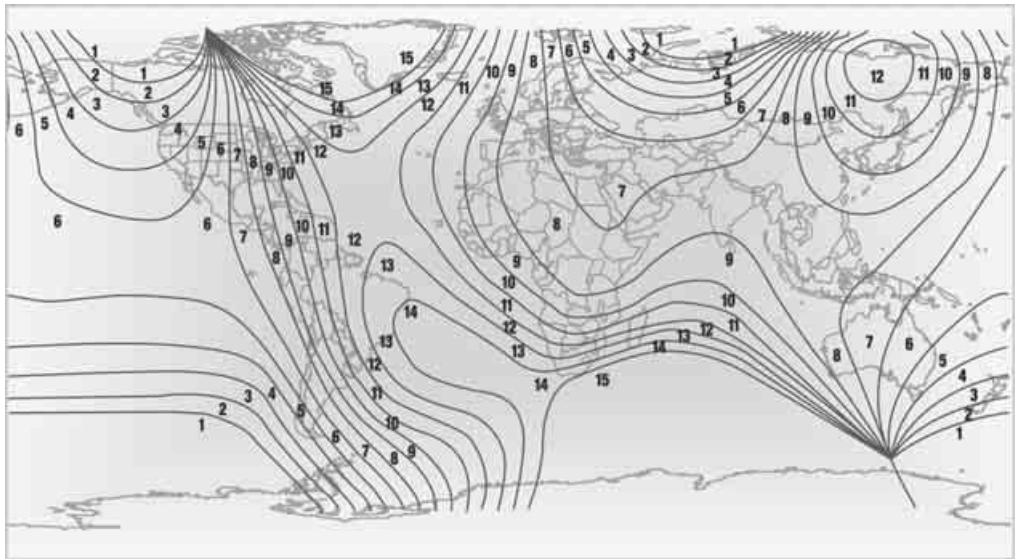

To set the compass zone, press the adjustment button for approx. 3-4 seconds. The number of the compass zone set is shown in the display.

To change the zone setting, briefly press the adjustment button repeatedly until the display shows the number of the compass zone corresponding to your current location.

The compass is operational again after approx. 10 seconds.

Calibrating the digital compass

The digital compass must be calibrated in the following situations:

- ▷ An incorrect compass direction is shown.
- ▷ The compass direction shown does not change although the direction of travel does.
- ▷ Not all compass directions are shown.

Procedure

1. Make sure that no large metal objects or overhead power lines are in the vicinity of your vehicle and that you have enough space to drive in a circle.
2. Set the currently valid compass zone.

3. Convertible: ensure that the retractable hardtop is fully closed.
4. Press the adjustment button for approx. 6-7 seconds to call up C. Then drive in a complete circle at a maximum speed of 5 mph/7 km/h. If the calibration is successful, the C will be replaced by the directions.
5. Convertible: open the retractable hardtop fully and repeat step 4.

Setting right-hand/left-hand steering

Your digital compass is factory-set to right-hand or left-hand steering, in accordance with your vehicle.

Setting the language

You can set the language of the display:

Press the adjustment button for approx. 12-13 seconds. Press the adjustment button again briefly to switch between English "E" and German "O".

The setting is automatically saved after approx. 10 seconds.

Coupe: Roller sunblinds

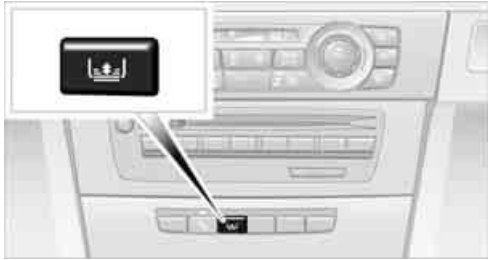

Briefly press the button in the center console to raise or lower the roller sunblind.

Glove compartment

Opening



Pull the handle.
The light in the glove compartment comes on.

 To prevent injury in the event of an accident while the vehicle is being driven, close the glove compartment immediately after use. ◀

Closing

Fold the cover up.

Locking

To lock the glove compartment, use the integrated key of the remote control, refer to page 32.

Convertible: when you lock the vehicle from the outside, the glove compartment is locked as well.

USB interface for data transmission

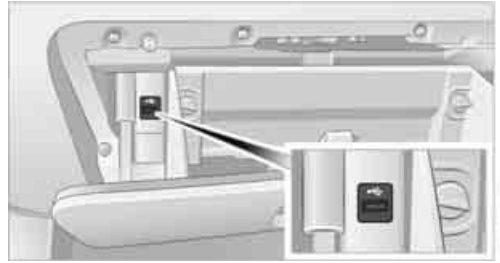

Port for importing and exporting data on USB devices, e.g. music collections, refer to page 185.

Observe the following when connecting:

- ▷ Do not use force when plugging the connector into the USB audio interface.
- ▷ Do not connect devices such as fans or lamps to the USB audio interface.
- ▷ Do not connect USB hard discs.
- ▷ Do not use the USB interface to recharge external devices.

Center armrest

Storage compartment

The center armrest between the front seats contains either a compartment or the cover for the snap-in adapter, depending on the equipment version.

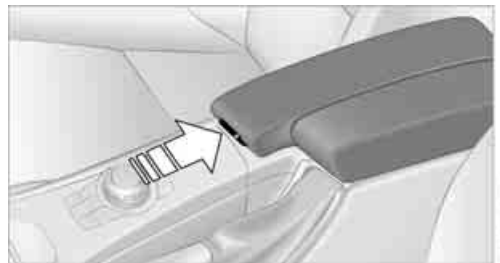

Opening

Press the button, see arrow.

Adjustments

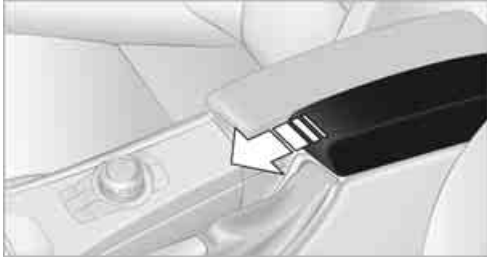

Slide the center armrest on the driver's side into the desired position.

Connection for external audio device

You can connect an external audio device such as a CD or MP3 player and play audio tracks over the vehicle speakers:

- ▷ AUX-IN port, refer to page 189.
- ▷ USB audio interface/extended connectivity of the music player in the mobile phone, refer to page 190.

Storage compartments inside the vehicle

Depending on your vehicle's equipment, you will find compartments beside the steering column, in the front doors and in the center console.

Nets are provided on the front-seat backrests.

 Do not place unsecured objects in them; otherwise, they could endanger the car's occupants, e.g. in the event of braking or evasive maneuvers. ◀

 Do not place non-slip pads, e.g. anti-slip mats, on the dashboard; the materials of these pads may damage it. ◀

Storage compartments in the rear console

Depending on your vehicle's equipment version, the following storage compartments can be found in the rear console:



- ▷ Storage tray
- ▷ Storage compartment with cover
- ▷ Cupholders

Coupe: clothes hooks

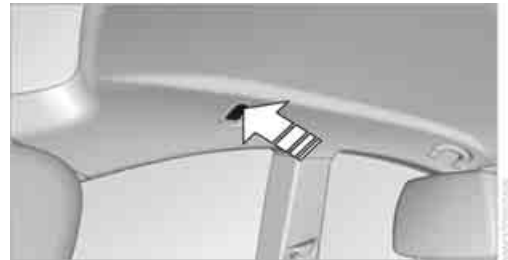

Press the upper edge to flip open.

 Items of clothing hung from the hooks must not obstruct the driver's view. Do not hang heavy objects from the hooks; otherwise, they could endanger the car's occupants, e.g. in case of heavy braking or sudden swerving. ◀

Cupholders

 Use lightweight and shatterproof containers and do not transport hot beverages; otherwise, there is an increased risk of injury in the event of the accident. Do not force containers that are too large into the cupholders; otherwise, damage could result. ◀

Front

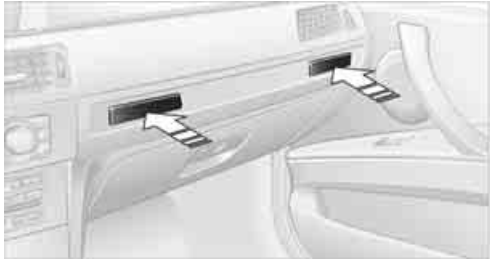

Opening

Briefly press the center of the cover.

Closing

Briefly press the cover in the center and push in the cupholder.

Coupe: rear

There are two additional cupholders in the rear center armrest.



Press the front of the armrest.

Convertible: rear

There are two additional cupholders in the rear console.

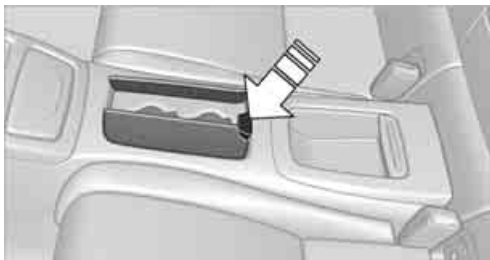

Press the button to open.



Before folding down the rear seat backrest or using the transport bag, remove all containers from the cupholder and close it. Do not place objects into the cupholder and use force to close it. Do not use the cupholder as a grab handle. ◀

Ashtray

Opening



Push the ridge on the cover.

Emptying



Lift out the insert.

Lighter



With the engine running or the ignition switched on, press in the cigarette lighter.

The lighter can be pulled out as soon as it pops back out.

 Hold or touch the hot cigarette lighter by the knob only. Holding or touching it in other areas could result in burns. When leaving the car, always remove the remote control so that children cannot operate the cigarette lighter and burn themselves. ◀

Connecting electrical appliances

In your BMW, when the engine is running or the ignition is switched on, you can use electrical devices such as a hand lamp, car vacuum cleaner, etc. if at least one of the following sockets is available.

The total load of all sockets should not exceed 140 watts at 12 volts.

Avoid damaging the sockets by attempting to insert plugs of unsuitable shape or size.

 Do not connect battery chargers to the sockets built into the vehicle at the plant; doing so may damage the vehicle. ◀

 Reinsert cigarette lighter or socket cover after use; otherwise items that fall into the cigarette lighter receptacle or the socket can cause a short circuit. ◀

Cigarette lighter socket

To access the socket: take the cigarette lighter out of the socket.

Socket in the front passenger footwell

A socket is located under the glove compartment on the left.

Socket in the center armrest

External audio device, refer to page 125.

Coupe: socket in trunk



Open the cap.

Coupe: Through-loading system

Opening



1. To release the rear seat backrest, pull the corresponding lever in the trunk.
2. The unlocked rear seat backrest moves forward slightly. Fold the backrest forward by the head restraint.



Closing

Return the rear seat backrest to its upright position and engage it.

 When returning the backrest to its seating position, make sure that the seat's locking mechanism engages properly. Otherwise, cargo could be thrown around in the event of sharp braking or swerving and endanger the occupants. ◀

The lashing eyes in the trunk provide you with a way to attach trunk nets or draw straps for securing suitcases and luggage, refer to page 140.

Convertible: Cargo loading

Hardtop closed

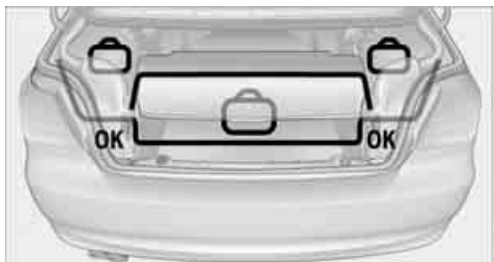

When the hardtop is closed, objects can be placed in the area below and near the cargo area cover.

Enlarging the trunk

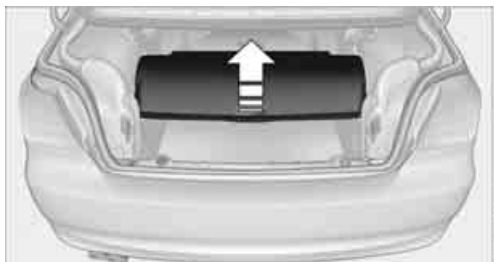

When the hardtop is closed you can enlarge the trunk:

To do so, push the trunk partition upward.

Hardtop opened

Before opening the hardtop, push the trunk partition down until it engages on both sides.



When the hardtop is open, objects can be placed under the cargo area cover. Do not place objects in those areas on the figure that are marked with an X.

 Before moving the hardtop, ensure that there are no objects on or next to the trunk partition; otherwise, parts of the hardtop may be damaged. Do not use force to push down the trunk partition. ◀

 The retractable hardtop can only be opened if the trunk partition is in its lowermost position and engaged on both sides. ◀

Folding down the rear seat backrest

Opening

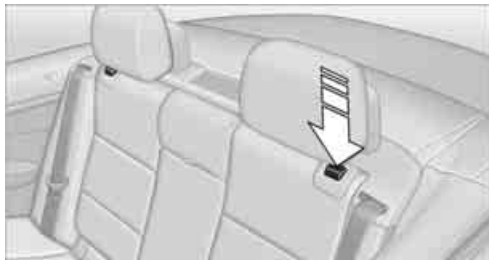

You can fold down the rear seat backrest to transport light objects in the rear without damaging the seats. Depending on the vehicle equipment, the mounting points for the trunk net are found on the rear panel of the backrest. To unlock the rear seat backrest: press the button on the driver's or the opposite side.

Closing

Return the rear seat backrest to the upright seating position and engage it.

 When returning the backrest to its seating position, make sure that the seat's locking mechanism engages properly. Otherwise, cargo could be thrown around in the event of sharp braking or swerving and endanger the occupants. ◀

Bag holder

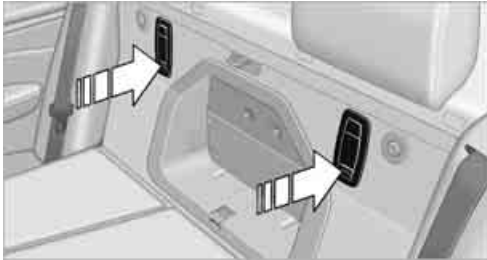

When the rear seat backrest is folded down, you will find two bag holders on the trunk wall:

1. Fold open the holder by pressing the button.
2. Press the handles of the bag onto the holder from above.

 Only hang light shopping bags or other suitable objects from the holders; otherwise, braking maneuvers and swerving, for example, may lead to a safety hazard due to objects flying around the passenger compartment. Only transport heavy luggage in the trunk if it has been appropriately secured. ◀

For more information on loading the vehicle, refer to page 139.

Storage compartment behind the rear seat backrest

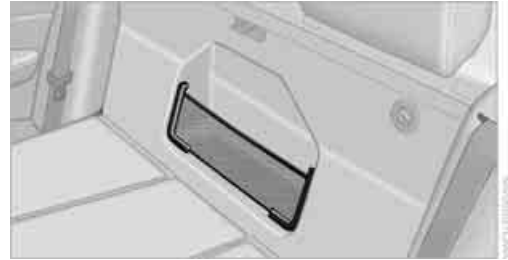

A storage compartment is located behind the rear seat backrest. To access the storage compartment: remove the insert or fold down the rear seat backrest.

 When the rear seat backrest is folded down or the insert has been removed, only transport small light objects in the storage compartment; otherwise, braking maneuvers and swerving, for example, may lead to a safety hazard due to objects flying around the passenger compartment. Only transport heavy luggage in the trunk if it has been appropriately secured. ◀

Storage compartments inside the trunk

Coupe

Depending on your vehicle's equipment, the following storage spaces can be found in the trunk:

- ▷ Left storage compartment, e.g. for storing a box of cleaning tissues or up to 12 CD jackets, depending on vehicle equipment version
- ▷ Net for securing smaller objects, to be attached to the mounts on the floor panel
- ▷ Hooks for hanging up, e.g., shopping bags or tote bags

- ▷ Rubber strap on the left trim panel for securing small objects such as a folding umbrella
- ▷ Net for small objects on the right trim panel of the trunk

Convertible

Depending on your vehicle's equipment, the following storage spaces can be found in the trunk:

- ▷ Storage compartment on the left side of the trunk. To open turn handle by 90°.
- ▷ Net for securing smaller objects, to be attached to the mounts on the floor panel
- ▷ Rubber strap for subdividing the trunk; can be hooked onto the lateral lashing eyes
- ▷ Stowage compartment under the floor panel

Folding up the floor panel

 Do not exceed the maximum permissible load of 55 lbs/25 kg for the storage compartment under the floor panel; otherwise, damage may result. ◀

Coupe

Press the floor panel up and secure it with the catch.

Convertible

To lift, grab hold of the floor panel at the opening at the rear of the panel.

Lashing eyes

You will find lashing eyelets in the trunk for securing luggage items with nets or tensioning straps, refer to page 140.

Coupe: ski bag

The ski bag is designed for safe, clean transport of up to 4 pairs of standard skis or up to 2 snowboards.

With the ski bag you can stow skis with a length of up to 6.9 ft/2.10 m. When skis of 6.9 ft/2.10 m length are loaded, the overall capacity of the ski bag is reduced due to its tapered design.

Loading

1. Fold down the center armrest.
2. Press the button, reach into the recess and fold down the cover.



3. Open the Velcro fastener, spread the ski bag between the front seats and insert the skis or snowboards.
4. Clip the hooks of the ski bag retaining strap into the eyelet.



Only place clean skis in the ski bag. Wrap sharp edges to prevent damage.

Securing cargo



After loading, secure the ski bag and its contents. Tighten the retaining strap on the tensioning buckle for this purpose.

! Secure the ski bag in the manner described; otherwise, it could endanger the car's occupants, e.g. in case of heavy braking or sudden swerving. ◀

To store the ski bag, perform the steps described for loading in reverse order.

Removing the ski bag

The ski bag can be completely removed, e.g. for faster drying or to allow you to use other inserts.

1. Fold down the center panel in the rear seat backrest.
2. Pull the handle, arrow 1.



3. Pull out the insert, arrow 2.

▶ For more information on the various inserts available, contact your BMW center. ◀

Convertible: through-loading opening with integrated transport bag

The transport bag is designed for safe, clean transport of up to 4 pairs of standard skis or up to 2 snowboards.

When the rear seat backrest is folded up, you can remove the insert and use the transport bag with the regular through-loading opening. To transport larger objects, you can fold down the rear seat backrest to create an expanded through-loading opening.

With the transport bag you can stow skis with a length of up to 6.2 ft/1.90 m. When skis of 6.2 ft/1.90 m length are loaded, the overall capacity of the transport bag is reduced due to its tapered design.

Loading

1. For loading using the regular through-loading opening:
Press the button down and remove the insert from the front.
For loading with the through-loading opening expanded:
Fold down the rear seat backrest, refer to page 128.

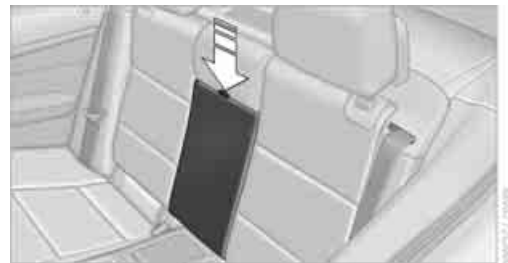

2. Front cover: press the two recesses together and fold the cover down until it engages.

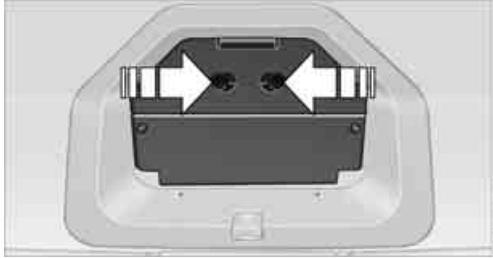

3. In the trunk: press the two recesses together and fold down the cover.

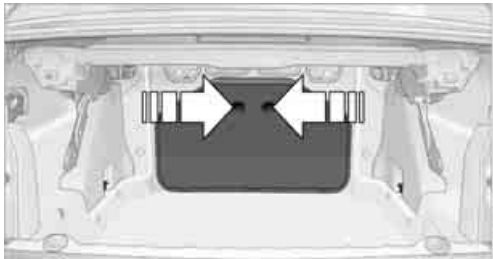

4. Undo the Velcro fastener and spread out the transport bag between the front seats.
5. Insert the latch plate of the retaining strap into the belt buckle under the transport bag.



6. Load the transport bag. The zipper eases access to the stored items.

Only place clean skis in the transport bag. Wrap sharp edges to prevent damage.

You can use the snaps to shorten the transport bag if you do not need its full length.

Securing cargo

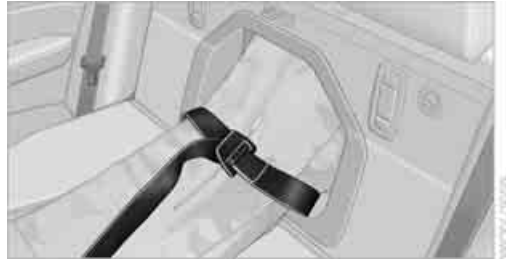

After loading, secure the transport bag and its contents. Tighten the retaining strap on the tensioning buckle for this purpose.

⚠ Secure the transport bag in the manner described; otherwise, it could endanger the car's occupants, e.g. in case of heavy braking or sudden swerving. ◀

To store the transport bag, perform the steps described for loading in reverse order.

Removing the front cover



You can remove the front cover to use the full height of the through-loading opening. With the cover folded down, pull the handle, see arrow, and remove the cover toward the front. To replace, insert the cover at an angle from above and let it snap it into place.



Driving tips

This section provides you with information useful in dealing with specific driving and operating conditions.

Things to remember when driving

Vehicle equipment

In this chapter, all production, country, and optional equipment that is offered in the model range is described. For this reason, descriptions will be given of some equipment that may not be available in a vehicle, for example due to the special options or national-market version selected. This also applies to safety related functions and systems.

Break-in period

Moving parts need breaking-in time to adjust to each other. Please follow the instructions below in order to achieve the optimal service life and economy of operation for your vehicle.

Engine and differential

Always obey all official speed limits.

Up to 1,200 miles/2,000 km

Drive at varying engine and road speeds, but do not exceed an engine speed of 4,500 rpm or a road speed of 100 mph/160 km/h.

Avoid full-throttle operation and use of the transmission's kickdown mode.

After driving 1,200 miles/2,000 km

Engine and vehicle speeds can be gradually increased.

Tires

Due to technical factors associated with their manufacture, tires do not achieve their full traction potential until after an initial break-in period. Therefore, drive cautiously during the first 200 miles/300 km.

Brake system

Brakes require an initial break-in period of approx. 300 miles/500 km to achieve optimized contact and wear patterns between brake pads and rotors. Drive cautiously during this break-in period.

Clutch

The function of the clutch reaches its optimal level only after a distance driven of approx. 300 miles/500 km. During this break-in period, engage the clutch gently.

Following part replacement

The same break-in procedures should be observed if any of the components mentioned above have to be renewed in the course of the vehicle's operating life.

Saving fuel

The fuel consumption of your vehicle depends on several factors. You can lower fuel consumption and the environmental impact by taking certain measures, adjusting your driving style and having the vehicle serviced regularly.

Remove any unneeded cargo

Additional weight increases fuel consumption.

Remove any mounted parts after you have finished using them

Remove unneeded additional mirrors, the roof rack and the rear luggage rack after use. Mounted parts affect the vehicle's aerodynamics and increase fuel consumption.

Close the windows and glass roof

An open glass roof or window causes higher air resistance and thus increases fuel consumption.

Check tire inflation pressure regularly

Check the tire inflation pressure at least twice a month and before embarking on a long journey, and correct it if necessary.

Low tire inflation pressure causes higher rolling resistance and thus increases fuel consumption and tire wear.

Set off immediately

Do not let the engine warm up while the car is still standing, but set off immediately at moderate engine speed. This is the fastest way for the cold engine to reach its operating temperature.

Drive defensively

Avoid unnecessary acceleration and braking maneuvers. To do so, keep an adequate distance between you and the vehicle in front of you. A defensive and smooth driving style keeps fuel consumption down.

Avoid high engine speeds

Only use first gear when setting off. In second and higher gears, accelerate without hesitation or pauses. When accelerating, shift up before reaching high engine speeds.

When you reach the desired speed, shift into the highest applicable gear and drive with the engine speed as low as possible and at a constant speed.

As a rule: driving at low engine speeds lowers fuel consumption and reduces wear.

Coasting

When approaching a red light, take your foot off the accelerator and coast to a stop in the highest applicable gear.

On a downhill slope, take your foot off the accelerator and coast in a suitable gear.

The fuel supply is interrupted when coasting.

Switch off the engine during lengthy stops

Switch off the engine when stopping for lengthy periods, e.g. at traffic lights, railroad crossings or in traffic congestions.

Switch off functions you do not need at the moment

Functions such as the air conditioner, seat heating or rear window defroster draw large amounts of power and consume additional fuel. Especially in city traffic and in stop-and-go driving they have a considerable impact. Therefore, switch these functions off when they are not really needed.

Have the vehicle serviced

Have the vehicle serviced regularly to achieve good economy and a long vehicle life. BMW recommends having the vehicle serviced at your BMW center. Also note the BMW Maintenance System, refer to page 260.

General driving notes

Close the trunk lid



Only drive with the trunk closed. Failure to do so may endanger passengers or other road users or may damage the vehicle in the event of an accident or a braking and evasive maneuver. In addition, exhaust gas may flow into the passenger compartment. ◀

If special circumstances make it absolutely necessary to drive with the trunk open:

1. Close all windows and the glass roof.
2. Greatly increase the air volume of the automatic climate control system, refer to page 117.
3. Drive cautiously.

Hot exhaust system

 In all vehicles, extremely high temperatures are generated in the exhaust system. Do not remove the heat shields installed adjacent to various sections of the exhaust system, and never apply undercoating to them. When driving, standing at idle and while parking, take care to avoid possible contact between the hot exhaust system and any highly flammable materials such as hay, leaves, grass, etc. Such contact could lead to a fire, with the risk of serious personal injuries and property damage. Do not touch hot exhaust tail pipes. Otherwise, there is a risk of burns. ◀

Mobile phones in the vehicle

 It is not advisable to use wireless devices such as mobile phones inside the vehicle without a direct connection to an external aerial. Otherwise, it is not possible to exclude the possibility of a reciprocal interference occurring between the vehicle electronics and the wireless device. Otherwise, there is no assurance that the radiation generated by the radio transmission will be conveyed out of the passenger compartment. ◀

Hydroplaning

 When driving on wet or slushy roads, reduce road speed. If you do not, a wedge of water can form between tires and road surface. This situation, known as hydroplaning, means that the tire can completely lose contact with the road surface, so that neither the car can be steered nor the brake be properly applied. ◀

The risk of hydroplaning increases with declining tread depth on the tires, refer also to Minimum tread depth on page 251.

Driving through water

 Drive through water on the road only if it is not deeper than 1 ft/30 cm, and then only at walking speed at the most. Otherwise, the vehicle's engine, the electrical systems and the transmission may be damaged. ◀

Use the parking brake on inclines

 On inclines, do not hold the vehicle for a lengthy period using the clutch; use the parking brake instead. Otherwise, greater clutch wear will result. ◀

-For more information about the drive-off assistant, refer to page 100.

Braking safely

Your BMW is equipped with ABS as a standard feature. Applying the brakes fully is the most effective way of braking in situations in which this is necessary. Since the vehicle maintains steering responsiveness, you can still avoid possible obstacles with a minimum of steering effort.

Pulsation of the brake pedal, combined with sounds from the hydraulic circuits, indicate that ABS is in its active mode.

Objects in the movement range of the pedals

 Keep floor mats, carpet, and other objects out of the movement range of the pedals; otherwise, they may inhibit the function of the pedals during driving.

Do not place additional floor mats onto an existing one or onto other objects.

Only use floor mats that have been approved for the vehicle and can be appropriately fastened. Make sure that the floor mats are securely fastened again after they have been removed, e.g. for cleaning. ◀

Driving in wet conditions

When roads are wet or there is heavy rain, briefly exert gentle pressure on the brake pedal every few miles. Monitor traffic conditions to ensure that this maneuver does not endanger other road users. The heat generated in this process helps dry the pads and rotors. Full braking efficiency will then be available when you need it.

Hills

 To prevent overheating and the resulting reduced efficiency of the brake system, drive long or steep downhill gradients in the gear in which the least braking is required. Even light but consistent brake pressure can lead to high temperatures, brake wear and possibly even brake failure. ◀

You can increase the engine's braking effect by shifting down, all the way to first gear if necessary. This strategy helps you avoid placing excessive loads on the brake system. Downshifting in manual mode of the automatic transmission, refer to page 66.

 Sport automatic transmission with double clutch: never drive with the transmission in neutral or with the engine switched off; otherwise, there will be no engine braking action and no power assistance to the brakes and steering. Manual transmission: never drive with the clutch held down, with the transmission in neutral or with the engine switched off; otherwise, there will be no engine braking action and no power assistance to the brakes and steering. ◀

Corrosion on brake rotors

When the vehicle is driven only occasionally, during extended periods when the vehicle is not used at all, and in operating conditions where brake applications are less frequent, there is an increased tendency for corrosion to form on rotors, while contaminants accumulate on the brake pads. This occurs because the minimum pressure which must be exerted by the pads during brake applications to clean the rotors is not reached.

Should corrosion form on the brake rotors, the brakes will tend to respond with a pulsating effect that even extended application will fail to cure.

When the vehicle is parked

Condensation forms while the automatic climate control is in operation, and then exits under the vehicle. Traces of condensed water under the vehicle are therefore normal.

Cargo loading

 To avoid loading the tires beyond their approved carrying capacity, never overload the vehicle. Overloading can lead to overheating and increases the rate at which damage develops inside the tires. In some situations, this can result in sudden loss of tire pressure. ◀

 Make sure that no liquids are spilled or leak from their containers in the trunk, as this could result in damage to the vehicle. ◀

Determining loading limit



1. Locate the following statement on your vehicle's placard:

 The combined weight of occupants and cargo should never exceed XXX kg or YYY lbs. Otherwise damage to the vehicle may occur and unstable driving conditions may result. ◀
2. Determine the combined weight of the driver and passengers that will be riding in your vehicle.
3. Subtract the combined weight of the driver and passengers from XXX kilograms or YYY pounds.
4. The resulting figure equals the available amount of cargo and luggage load capacity. For example, if the YYY amount equals

1,400 lbs and there will be five 150-lb passengers in your vehicle, the amount of available cargo and luggage load capacity is 650 lbs:

1,400 lbs minus 750 lbs = 650 lbs.

5. Determine the combined weight of luggage and cargo being loaded on the vehicle. That weight may not safely exceed the available cargo and luggage load capacity calculated in step 4.
6. If your vehicle will be towing a trailer, part of the load from your trailer will be transferred to your vehicle. Consult the manual for transporting a trailer to determine how this may reduce the available cargo and luggage load capacity of your vehicle.

Load

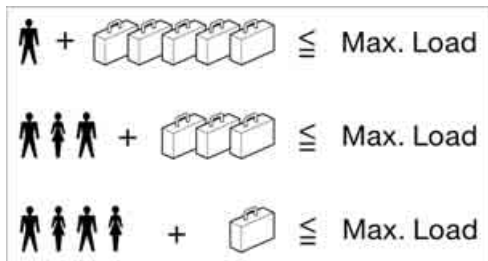

The permissible load is the total of the weight of occupants and cargo/luggage. The greater the weight of the occupants, the less cargo/ luggage can be transported.

Stowing cargo

Coupe

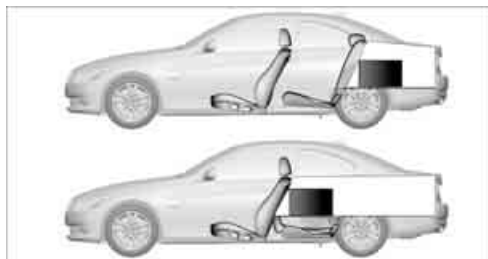

Convertible

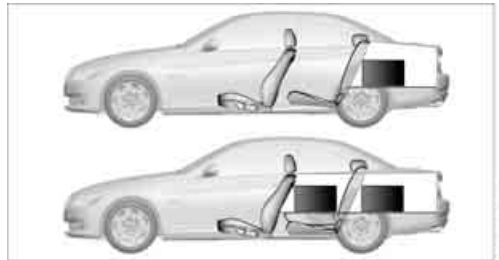

Stowing cargo

- ▷ Position heavy objects as low and as far forward as possible, ideally directly behind the respective seat backrests.
- ▷ Cover sharp edges and corners.
- ▷ For very heavy cargo when the rear seat is not occupied, secure each safety belt in the opposite buckle.

Securing cargo

Coupe

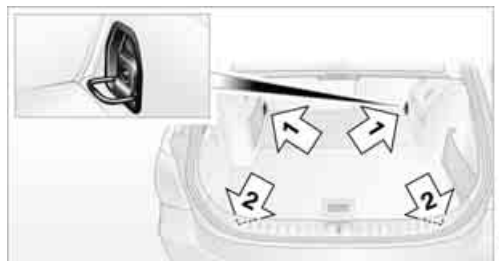

Convertible

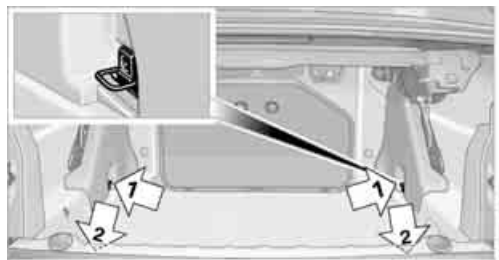

Securing cargo

- ▷ Secure smaller and lighter items using retaining straps, a trunk net, or draw straps.
- ▷ Heavy-duty cargo straps for securing larger and heavier objects are available at your BMW center. Four lashing eyes are provided for attaching the cargo straps. Two are located on the side walls of the trunk **1** and two additional ones are located on the inside wall of the trunk **2**.

Comply with the information enclosed with the load-securing devices.

 **Convertible:** before opening the hardtop, fold down the trunk partition. Make sure the trunk is loaded correctly; otherwise parts of the hardtop can be damaged, refer to page [128](#). ◀

 Always position and secure the cargo as described above, so that it cannot endanger the car's occupants, for example if sudden braking or swerving is necessary.

Never exceed either the approved gross vehicle weight or either of the approved axle loads, refer to page [281](#), as excessive loads can pose a safety hazard, and may also place you in violation of traffic safety laws.

Heavy or hard objects should not be carried loose inside the car, since they could be thrown around, for example as a result of heavy braking, sudden swerves, etc., and endanger the occupants.

Only attach the cargo straps using the lashing eyes shown in the illustration. Do not secure cargo with the anchors for tether straps, refer to page [60](#); otherwise, these could be damaged. ◀

Coupe: roof-mounted luggage rack

A special rack system is available as an option for your BMW. Comply with the directions given in the installation instructions.

Mounting points

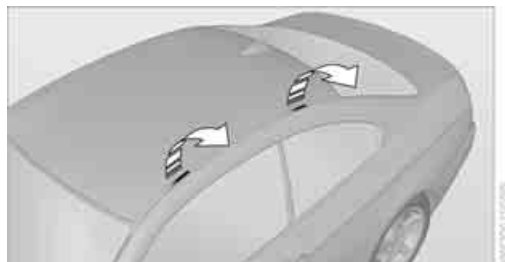

The mounting points are located in the roof.

Loading roof-mounted luggage rack

Because roof racks raise the vehicle's center of gravity when loaded, they have a major effect on vehicle handling and steering response.

You should therefore always remember not to exceed the approved roof load capacity, the approved gross vehicle weight or the axle loads when loading the rack.

You can find the applicable data under **Weights** on page [281](#).

The roof load must be distributed uniformly and should not be too large in area. Heavy items should always be placed at the bottom. Be sure that adequate clearance is maintained for tilting the glass roof, and that objects do not project into the opening path of the trunk lid.

Fasten roof-mounted cargo correctly and securely to prevent it from shifting or falling off during the trip.

Drive smoothly. Avoid sudden acceleration and braking maneuvers. Take corners gently.



Navigation

This chapter describes how you can enter destinations and specify your route so that your navigation system guides you reliably to your destination.

Navigation system

Vehicle equipment

In this chapter, all production, country, and optional equipment that is offered in the model range is described. Equipment is also described that is not available because of, for example, selected options or country version. This also applies to safety related functions and systems.

General information

The navigation system can determine the precise position of the vehicle, with the aid of satellites and vehicle sensors, and can reliably guide you to every entered destination.



Enter data only with the vehicle stationary, and always give priority to the applicable traffic regulations in the event of any contradiction between traffic and road conditions and the instructions issued by the navigation system. Failure to take to this precaution can place you in violation of the law and put vehicle occupants and other road users in danger. ◀

Accessing navigation system

1.  Press the button.
2. "Navigation"



The navigation system can also be accessed directly with the button on the controller.

Navigation data

General information

Navigation data and authorization codes are available from your BMW center. Navigation data are stored in the vehicle and can be updated.

- ▷ Depending on the data volume, a data update may take several hours.
- ▷ Update data while driving to reduce the drain on the battery.
- ▷ Only the main functions of the navigation system are available during updating.

The update is resumed automatically when a trip is continued after an interruption.

- ▷ You can inquire as to the status of the update.
- ▷ The data are stored in the vehicle.
- ▷ After the update, the system restarts.
- ▷ The medium that holds the navigation data can be removed after the update is completed.

Information about navigation data

1. "Navigation"
2. Open "Options".
3. "Navigation system version": Information about the data version is displayed.

Updating the navigation data

Inserting navigation DVD

1. Insert the navigation DVD into the DVD player with the labeled side facing up.
2. Follow the instructions on the Control Display.
3. Enter the authorization code of the navigation DVD and change the DVD if needed.

Removing navigation DVD



1. Press the  button **1**.
The DVD emerges slightly from the drive.
2. Remove the DVD.

Querying status

1.  Press the button.
2. "Navigation update"

Destination entry

Vehicle equipment

In this chapter, all production, country, and optional equipment that is offered in the model range is described. Equipment is also described that is not available because of, for example, selected options or country version. This also applies to safety related functions and systems.

General information

In entering your destination you can select from the following options:

- ▷ Entering a destination manually, see below
- ▷ Selecting destination from address book, refer to page 148
- ▷ Last destinations, refer to page 149
- ▷ Special destinations, refer to page 149
- ▷ Entering a destination on the map, refer to page 151
- ▷ Selecting home address, refer to page 149
- ▷ Destination entry via voice, refer to page 152
- ▷ Destination entry via BMW Assist, refer to page 151

You can also store a navigation destination on the programmable memory keys, refer to page 25.

Entering a destination manually

To make it easier to enter town/city names and street names, the system assists you with automatic name completion and entry comparison, refer to page 155. This makes it possible to enter different spellings and completes your entry automatically so that stored town/city names and street names can be accessed quickly.

1.  Press the button.
2. "Navigation"
3. "Enter address"



The system also supports you with the following features:

- ▷ If you do not enter a street, the system will guide you to the downtown area of a town or city.
- ▷ You can skip the entry of state/province and town/city if the current entries should be retained for your new destination.

Entering a state/province

1. "Navigation"
2. "Enter address"
3. Select "State/Province" or displayed country.

Entering a town/city

1. Select "Town/City/Postal Code" or the displayed town/city.

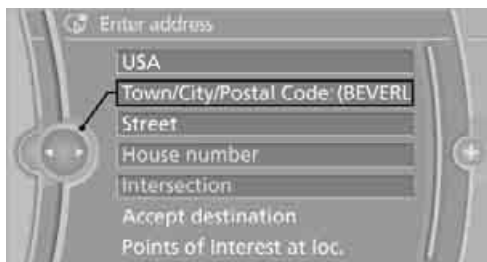

2. Select letters, if necessary.
The list is reduced in steps with each entry.
To delete letters:
 - ▷ To delete individual letters:
Turn the controller to select **⏪**, and then press the controller.
 - ▷ To delete all letters:
Turn the controller to select **⏪**, and then press the controller for an extended period.
 To enter spaces:
 - ▷ Select the **□** symbol.
 The list gradually grows smaller each time you enter a new letter.
3. Move the controller to the right.
4. Select the name of the town/city from the list.

If there are several towns/cities with the same name:

1. Change to the list of town/city names.
2. Highlight the town/city.
3. Select the town/city.

Entering the postal code

1. Select "Town/City/Postal Code" or the displayed town/city.
2. Select the **1@+** symbol.
3. Select the digits.
4. Change to the list of postal codes and towns/cities.
5. Highlight the entry.
6. Select an entry.

Entering street and intersection

1. Select "Street" or displayed street.
2. Enter the street and cross-street the same way you entered the town/city.

After you enter the street, you can also enter the cross street or the house number.

If there are several streets with the same name:

1. Change to the list of street names.
2. Highlight street.
3. Select the street.

Alternative: entering street and house number

1. Select "Street" or displayed street.
2. Enter the street the same way you entered the town/city.
3. "House number"
4. Select the digits.
5. Change to the list of house numbers.
6. Select a house number or range of house numbers.

No such street at the destination

The desired street is not in the entered town/city because it belongs to another district of the town/city.

1. "Navigation"
2. "Enter address"
3. Select "Street" or displayed street.
4. Change to the list of street names.
5. Select "In" displayed country.

All streets of the entered country are offered. The corresponding town/city is displayed after the street name.

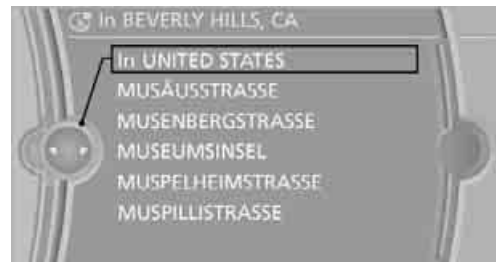

6. Select the letters.
7. Change to the list of street names.
8. Highlight street.
9. Select the street.

Starting destination guidance after entering the destination

1. "Accept destination"
 2. "Start guidance" or "Add as another destination", refer to page 153.
- ▷ Setting "Route preference", refer to page 155.
 - ▷ Search for "Points of Interest at loc.", refer to page 149.

Address book

To create contacts, refer to page 224.

Selecting a destination from the address book

1. "Navigation"
2. "Address book"
Contacts with addresses are displayed if these addresses have been checked as destinations.

If the contacts with addresses from the mobile phone are not displayed, they first need to be checked as destinations, refer to page 214.

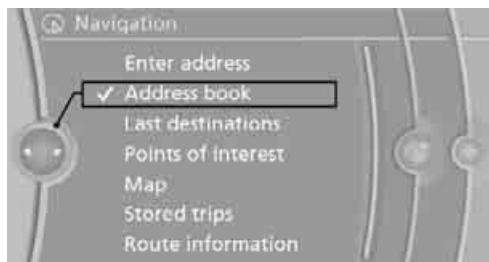

3. Select a contact in the list or if so desired, using the "A-Z search".
4. Select "Business address" or "Home address"

Storing a destination in the address book

Store the destination in the address book after entering the destination.

1. "Navigation"
2. "Map"
3. "Guidance"
4. Open "Options".
5. "Store as new contact" or "Add to existing contact".



6. Select an existing contact, if available.
7. "Business address" or "Home address"
8. "Last name" and "First name" if you wish.
9. "Store in vehicle"

Storing the position

Your current position can be stored in the address book.

1. "Navigation"
2. Open "Options".
3. "Store position as contact" or "Add position to contact".



4. Depending on the selection, select an existing contact from the list or the type of address and enter the last and first name.
5. "Store in vehicle"

Editing or deleting an address

1. "Navigation"
2. "Address book"
3. Highlight the entry.
4. Open "Options".
5. "Edit in Contacts" or "Delete entry".

Using the home address as a destination

The home address must be created. Specifying a home address, refer to page 224.

1. "Navigation"
2. "Address book"
3. "Home"

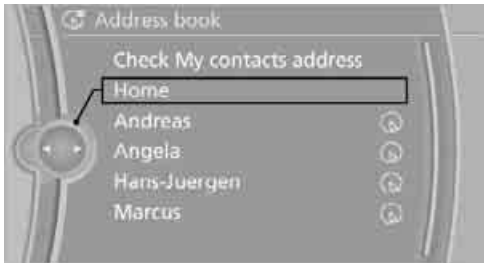

4. "Start guidance"

Last destinations

The last destinations are stored automatically. These destinations can be called up and used as a destination for destination guidance.

Opening the last destinations

1. "Navigation"
2. "Last destinations"

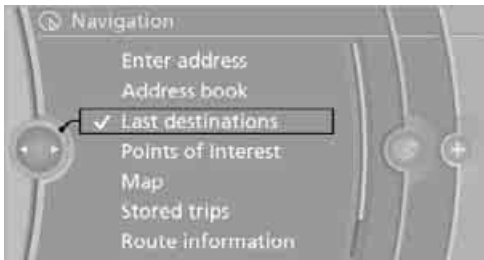

3. Select the destination.
4. "Start guidance" or "Add as another destination"

Editing a destination

Destinations can be edited, for example, to change the house number of an existing entry.

1. "Navigation"
2. "Last destinations"
3. Highlight the destination.
4. Open "Options".
5. "Edit destination"

Deleting the last destinations

1. "Navigation"
2. "Last destinations"
3. Highlight the destination.
4. Open "Options".
5. "Delete entry" or "Delete all last destinations".

Special destinations

General information

Even with the most up-to-date navigation data, information about certain special destinations may have changed; for example, filling stations may not be in operation.

Opening the search for special destinations

1. "Navigation"
2. "Points of Interest"

The search can be narrowed by entering the location and type of special destination.

Searching online

1. "Google™ Local Search"
2. Select the special destination.
3. Select the  symbol.
4. "Start guidance"

Special destination location

As you input the search destination, you can select from among various options.

- ▷ "At current location"
- ▷ "At destination"
- ▷ "At different location"
- ▷ "Along route"

A-Z search

1. "A-Z search"
2. "Town/City"
3. Select or enter town/city.
4. "Category"
5. Select category.
6. "Category details"
For some special destinations, it is possible to select several category details. Move the controller toward the left to exit category details.
7. "Keyword"
8. Enter keyword.
A list of the special destinations is displayed.
9. Select the special destination.
Details are displayed.
If several details are stored, then you can scroll through the pages.
If a phone number is available, a connection can be established, if desired.
10. Select the  symbol.
11. "Start guidance" or "Add as another destination". Adding destination as another destination, refer to page 153.

"Start search": without entering a search term, the search is repeated with the last stored search term.

Category search

1. "Category search"
2. "Town/City"
3. Select or enter town/city.
4. "Category"
5. Select category.
6. "Category details"
For some special destinations, it is possible to select several category details. Move the controller toward the left to exit category details.
7. "Start search"
A list of the special destinations is displayed.
8. Select the special destination.
Details are displayed.
If several details are stored, then you can scroll through the pages.
If a phone number is available, a connection can be established, if desired.
9. Select the  symbol.
10. "Start guidance" or "Add as another destination". Adding destination as another destination, refer to page 153.

Displaying special destinations

List of special destinations: the special destinations are displayed in order of their distance and are displayed with a direction arrow pointing toward the destination.

With the Professional navigation system:
In the split screen, special destinations from the selected category are displayed as symbols in the map view. The display depends on the map scale and the category.

Destination entry via BMW Assist

A connection to the BMW Concierge service is established, refer to page 225.

1. "Navigation"
2. "Enter address"
3. Open "Options".
4. "BMW Assist dest. entry"

Displaying special destinations in the map

To display symbols of the special destinations in the map:

1. "Navigation"
2. "Map"
3. Open "Options".
4. "Display Points of Interest"



5. Select the settings.

Destination entry via map

If you only know the location of a destination or street, then you can enter the destination with the aid of the map.

Selecting the destination

1. "Navigation"
2. "Map"

The current position of the vehicle is displayed on the map.

3.  "Interactive map"

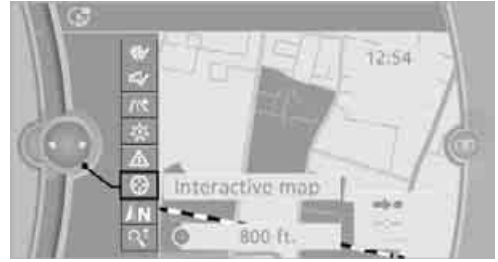

4. Select the destination with the cross-hairs.
 - ▷ To change the scale: turn the controller.
 - ▷ To shift the map: move the controller in the required direction.
 - ▷ To shift the map diagonally: move the controller in the required direction and turn it.
5. Press the controller to display additional menu items.
 - ▷ Select the  symbol: "Start guidance" or "Add as another destination".
 - ▷ "Find points of interest": the search for special destinations is started.

Specifying the street

If the system cannot recognize a street, it displays one of the following pieces of information:

- ▷ A street name in the vicinity.
- ▷ The district.
- ▷ The coordinates of the destination.

Interactive map

In the interactive map, the scale can be adjusted and the visible map section can be shifted. In addition, pressing the controller makes further functions available:



- ▷ Select the  symbol. "Start guidance" or "Add as another destination"
- ▷ "Exit interactive map": Go back to the map view.
- ▷ "View in northern direction" or "View in driving direction"
- ▷ "Display destination": the section of the map around the destination is displayed.
- ▷ "Display current location": The section of the map around the current position is displayed.
- ▷ "Find points of interest", refer to page 149.

Destination entry via voice

General information

For instructions on the voice activation system, refer to page 27.

- ▷ During the destination entry by voice, you can switch between voice operation and entry via iDrive at any time. To do so, reactivate the voice activation system if necessary.
- ▷ Having the possible spoken commands read aloud: ›Voice commands‹



Saying the entries

- ▷ With the Professional navigation system: City/town, street, and house number can be entered with a single command.
- ▷ Countries, towns and cities, streets and intersections can be said as whole words or spelled in the system language, refer to page 95.

Example: to enter a destination in a US state as a complete word, the system language must be English.

- ▷ Spell the entry if the language spoken in the area is different from the system language.
- ▷ Say the letters smoothly, and avoid exaggerating the pronunciation and inserting lengthy pauses between the letters.
- ▷ The methods of entry depend on the navigation data in use and on the country and language settings.

Entering an address in a command



1. Press the  button on the steering wheel.
-  2. ›Enter address‹
3. Wait for a request from the system.
4. Say the address aloud in the suggested order.
5. Continue making the entry as prompted by the system.

If necessary, individually name the separate components of the address, e.g. the town/city.

Entering a town/city

The town/city name can be spoken as a complete word or spelled.

With the destination entry menu displayed:

1. Press the  button on the steering wheel.
-  2. ›City‹ or ›Spell city‹.
3. Wait for the system to prompt you for the town/city.

- Say the name of the town/city or say at least the first three letters.

Depending on the entry, up to 20 towns/cities may be suggested.

- Select a location:
 - ▶ To select a recommended town/city: ›Yes‹
 - ▶ To select other town/city: ›New entry‹
 - ▶ To select an entry, e.g. ›Entry ...‹
 - ▶ To spell an entry: ›Spell city‹
- Continue making the entry as prompted by the system.

If there are several towns/cities with the same name:

Towns/cities that sound the same are compiled in a separate list and are displayed as one town/city followed by three dots.

- Select an entry:

›Yes‹ or ›Entry ...‹ e.g. entry 2.

- Select the desired town/city.

The town/city can also be selected from the list via iDrive: turn the controller until the town/city is selected and press the controller.

Entering a street or intersection

The street or intersection is entered in the same manner as the town/city.

Entering a house number

Depending on the data in the navigation system, house numbers up to the number 2,000 can be entered:

- ›House number‹
- Say the house number.
Say each digit separately.
- Continue making the entry as prompted by the system.

Starting destination guidance

›Start guidance‹

Destination guidance starts immediately.

Planning a trip with intermediate destinations

New trip

A trip can be planned using intermediate destinations.

- "Navigation"
- "Map"
- Move the controller to the left, if necessary.
- ✎ "Guidance"
- "Enter new destination"
- Select the type of destination entry.

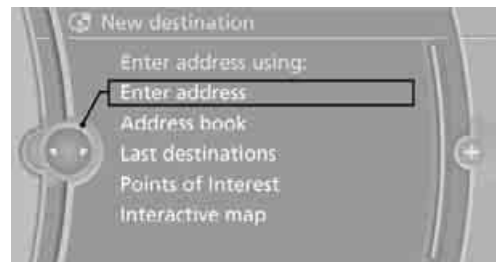

- Enter the intermediate destination.
- "Start guidance"

Entering intermediate destinations

A maximum of 30 intermediate destinations can be entered for one trip.

- "Enter new destination"
- Select the type of destination entry.
- Enter the intermediate destination.
- "Add as another destination"
The intermediate destination is inserted into the destination list and highlighted.
- Turn the controller until the intermediate destination is at the desired place in the list.
- Press the controller.

Starting the trip

After entering all intermediate destinations, highlight the first destination and say "Start guidance"

For example if the second destination is highlighted at the start of route guidance, then the first destination is skipped over.

The  symbol indicates the active intermediate destination.

Storing a trip

Up to 30 trips can be stored in the trip list. Delete existing trips as necessary to permit you to store new trips.

1. Open "Options".
2. "Store trip"
3. Enter a name.
4. "OK"

The trip is stored in the trip list under the entered name.

Selecting a stored trip

1. "Navigation"
2. "Stored trips"
3. Select the desired trip.
4. "Start guidance"

Trips, changing

Changing the trip direction

Intermediate destinations are displayed in reverse order in the list.

1. "Map"
2.  "Guidance"
3. Open "Options".
4. "Reverse order of trip dest."

Options for intermediate destinations

1. "Map"
2.  "Guidance"
3. "Display all trip destinations"
4. Select an intermediate destination.
 - ▷ "Edit destination"
 - ▷ "Reposition dest. in the trip": move the intermediate destination within the list.
 - ▷ "Delete dest. in the trip"
 - ▷ "Go to next dest. in the trip"

Some options are not possible for some trips.

Deleting a stored trip

1. "Navigation"
2. "Stored trips"
3. Select the desired trip.
4. Open "Options".
5. "Delete all trips" or "Delete trip".

Selecting last trip

1. "Navigation"
2. "Stored trips"
3. "Last trip"
4.  "Start guidance"

Destination guidance

Vehicle equipment

In this chapter, all production, country, and optional equipment that is offered in the model range is described. Equipment is also described that is not available because of, for example, selected options or country version. This also applies to safety related functions and systems.

Starting destination guidance

1. "Navigation"
2. Entering a destination, refer to page 146.
3. "Accept destination"
4. "Start guidance"

The route is displayed on the Control Display after it is calculated.

In the map view, the distance to the destination/intermediate destination and the estimated time of arrival are displayed.

The arrow display appears on the Control Display, if so desired.

Terminating destination guidance

1. "Navigation"
2. "Map"
3.  "Guidance".
4. "Stop guidance"

Continuing destination guidance

If the destination was not reached during the last trip, destination guidance can be resumed.







"Resume guidance"

Route criteria

General information

- ▷ You can influence the calculated route by selecting certain trip criteria.
- ▷ Route criteria can be changed during destination entry and during route guidance.
- ▷ Street types are part of the navigation data and are taken into account in route planning, e.g. avoiding highways.
- ▷ The proposed route can differ from personal experience.
- ▷ The settings are stored for the remote control currently in use.
- ▷ Route guidance with traffic bulletins, refer to page 161.

Changing route criteria

1. "Navigation"
2. "Map"
3.    "Route preference"
4. Selecting a criterion:
 - ▷  "Fast route": time-optimized route through a combination of the least possible distance and stretches of road that allow rapid driving.
 - ▷  "ECO PRO route": optimized combination of the fastest and shortest possible route.
 - ▷  "Short route": short distance without taking time into account.
 - ▷ "Alternative routes": are suggested, where possible, during active route guidance. The individual suggestions are labeled in color.

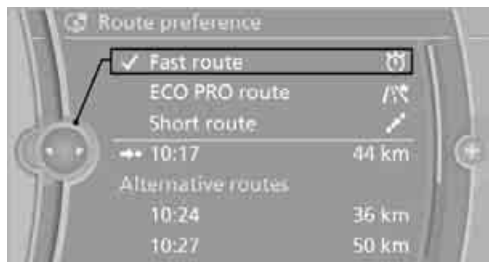

5. Select additional route criteria, if desired. Where possible, the selected criteria will be avoided on the route.
 - ▷ "Avoid highways": highways are avoided where possible.
 - ▷ "Avoid toll roads": toll roads are avoided where possible.
 - ▷ "Avoid ferries": ferries are avoided where possible.

The setting applies to the current route and to the planning of future routes.

Route

General information

Depending on your vehicle's equipment, various views of the route are available during route guidance:

- ▷ Arrow display on the Control Display.
- ▷ List of route segments.
- ▷ Map view, refer to page 157.

Arrow display

The following information is displayed during route guidance:

- ▷ Large arrow: current direction of travel.
- ▷ Small arrow: indicates the next change of direction.
- ▷ Intersection view.

- ▷ Lane information.
- ▷ Traffic bulletins.
- ▷ Distance to the next change of direction.
- ▷ Street name of the next change of direction.

Lane information

In the arrow display, the recommended lanes of multi-lane roads are each marked with a triangle.

- ▷ Filled triangle: optimum lane.
- ▷ Empty triangle: likewise possible lane. It can, however, also be possible to briefly make additional lane changes.

Displaying the list of route segments

If the route guidance has been started, then you can display a list of route segments. The distance to be traveled and traffic bulletins are displayed for each segment of the route.

1. "Navigation"
2. "Route information"
3. Highlight the route segment.

The route segment is displayed in the preview map.

Bypassing a section of the route

During route guidance, prompt the navigation system to bypass certain route segments. In doing so, you will specify how many kilometers to travel before returning to the original route.

1. "Navigation"
2. "Route information"
3. "New route for"



4. Turn the controller: enter the desired mileage.
5. Press the controller.

Resuming the original route

If the route section should no longer be bypassed:

1. "Navigation"
2. "Route information"
3. "New route for"
4. "Remove blocking"

Gas station recommendations

The remaining range is calculated and filling stations along the route are displayed.



Even with the most up-to-date navigation data, information about certain special destinations may have changed; for example, filling stations may not be in operation.

1. "Navigation"
2. "Route information"
3. "Recommended refuel"
A list of filling stations is displayed.
4. Select a gas station.
5. Select the  symbol.
6. "Start guidance": route guidance to the selected filling station is started.
"Add as another destination": the filling station is incorporated into the route.

Destination guidance through voice instructions

Switching voice instructions on/off

Voice instructions can be switched on or off during destination guidance.

1. "Navigation"
2. "Map"
3.   "Voice instructions"

For rapid access, the feature can be stored on a programmable memory key, refer to page 25.

Repeating a voice instruction

1. "Navigation"
2. "Map"
3. Highlight the  symbol.
4. Press the controller twice.

Adjusting volume for voice instructions

The volume can be adjusted only while a voice instruction is being issued.

1. Have the last voice instruction repeated, if necessary.
2. Turn the button during the voice instruction to select the desired volume.



The setting is stored for the remote control currently in use.

Map view

Displaying the map view

1. "Navigation"
2. "Map"

Overview

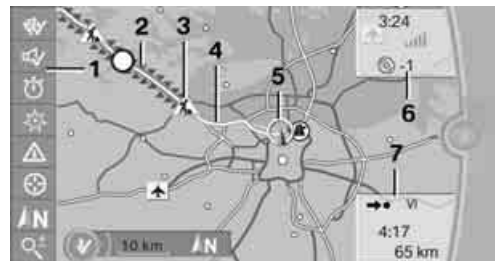

- 1 Toolbar
- 2 Route segment with traffic obstruction
- 3 Road sign for traffic obstruction
- 4 Planned route
- 5 Current location
- 6 Upper status box
- 7 Lower status box

Lines on the map

Streets and roads are depicted with different colors and lines according to their classification. Dotted lines represent railroad and ferry connections. National borders are depicted with thin lines.

Traffic obstructions

Small triangles along the planned route identify route segments with traffic obstructions, depending on map scale. The direction of the triangles indicates the direction of the obstruction.

Road signs classify the obstructions.

- ▷ Red road sign: the obstruction relates to the planned route or direction of travel.
- ▷ Gray road sign: the obstruction does not relate to the planned route or direction of travel.

Traffic bulletins, refer to page 159.

Planned route

After route guidance is started, the planned route is displayed on the map.









Status boxes

Show/hide: press the controller.

- ▷ Upper status box: time, phone details, and entertainment details.
- ▷ Lower status box: symbol for active route guidance, traffic bulletin status, arrival time, and distance from destination.

Toolbar

The following functions are available directly in the map view:

Symbol	Function
	Starting/stopping destination guidance
	Switching voice instructions on/off
	Changing route criteria or selecting route alternatives
	Special destinations
	Displaying traffic bulletins
	Interactive map
	Map view settings
	Changing scale

Changing the map section

- ⊕ "Interactive map"
- ▷ To shift the map: move the controller in the required direction.
- ▷ To shift the map diagonally: move the controller in the required direction and turn it.

Changing scale

1. Select the  symbol.
2. Turn the controller to adjust the scale.

Automatic scaling of the map

In the map view facing north, turn the controller in any direction until AUTO is displayed as the map scale.

The map shows the entire range from your location to the destination.

Settings for the map view

The map is shown on the Control Display.

1. Open "Options".
2. "Settings"

Set the optimized map view.

- ▷ "Day/night mode"
Select and adjust depending on light conditions.
- "Traffic conditions/gray map" active:
Settings are not taken into account.
- ▷ "Satellite images"
Depending on the availability and resolution, satellite images are displayed in scales of approx. 1 mile to 600 miles/2 km to 1,000 km.
- ▷ "Perspective view in 3D"
Displays a three-dimensional view. Prominent areas that are contained in the navigation data are displayed on the map in 3D.
- ▷ "Traffic conditions/gray map"
The map is optimized for displaying traffic bulletins. Symbols for the special destinations are no longer displayed.

Map view for the split screen display

The map view for the split screen can be selected separately from the main screen.

1. Open "Options".
2. "Split screen"
3. Move the controller to the right repeatedly until the split screen content is selected.
4. Select "Split screen content" or scale.
5. Select the map view:
 - ▷ "Arrow display"
 - ▷ "Map facing north"
 - ▷ "Map direction of travel"
 - ▷ "Map view with perspective"
 - ▷ "Position"
 - ▷ "Exit ramp view"
 - ▷ "Traffic conditions/gray map"
6. To change the scale: switch to the split screen and turn the controller.

Traffic bulletins

Overview

- ▷ You can display the traffic bulletins from radio stations that broadcast the TMC (Traffic Message Channel) of a traffic information service. Bulletins about traffic obstructions and hazards are continuously updated.
 - ▷ Traffic bulletins are indicated by symbols on the map.
 - ▷ Traffic bulletins for the surrounding area are stored in a list.
- ⚠** The symbol in the toolbar of the map view turns red if a traffic bulletin relates to the calculated route.

Real Time Traffic Information End-User Provisions

Certain BMW models equipped with navigation have the capability to display real-time traffic information. If your system has this capability the following additional terms and conditions apply:

An End-User shall no longer have the right to use the Traffic Data in the event that the End-User is in material breach of the terms and conditions contained herein.

A. Total Traffic Network, a division of Clear Channel Broadcasting, Inc. ("Total Traffic Network") holds the rights to the traffic incident data and RDS-TMC network through which it is delivered. You may not modify, copy, scan or use any other method to reproduce, duplicate, republish, transmit or distribute in any way any portion of traffic incident data. You agree to indemnify, defend and hold harmless BMW of North America, LLC. ("BMW NA") and Total Traffic Network, Inrix, Inc (and their affiliates) against any and all claims, damages, costs or other expenses that arise directly or indirectly out of (a) your unauthorized use of the traffic incident data or the RDS-TMC network, (b) your

violation of this directive and/or (c) any unauthorized or unlawful activities by you in connection herewith.

B. Total Traffic Network traffic data is informational only. User assumes all risk of use. Total Traffic Network, BMW NA, and their suppliers make no representations about content, traffic and road conditions, route usability, or speed.

C. The licensed material is provided to license "as is," and "where is". Total Traffic Network, including, but not limited to, any and all third party providers of any of the licensed material, expressly disclaims, to the fullest extent permitted by law, all warranties or representations with respect to the licensed material (including, without limitation, that the licensed material will be error-free, will operate without interruption or that the traffic data will be accurate), express, implied or statutory, including, without limitation, the implied warranties of merchantability, non-infringement fitness for a particular purpose, or those arising from a course of dealing or usage of trade.

D. Neither Total Traffic Network, Inrix, Inc. nor BMW NA will be liable to you for any indirect, special, consequential, exemplary, or incidental damages (including, without limitation, lost revenues, anticipated revenues, or profits relating to the same) arising from any claim relating directly or indirectly to use of the traffic data, and even if Total Traffic Network, Inrix, Inc., or BMW NA are aware of the possibility of such damages. These limitations apply to all claims, including, without limitation, claims in contract and tort (such as negligence, product liability and strict liability). Some states do not allow the exclusion or limitation of incidental or consequential damages, so those particular limitations may not apply to you.

Activating/deactivating reception

1. "Navigation"
2. Open "Options".
3. "Receive Traffic Info"

Accessing traffic bulletins

1. "Navigation"
2. "Map"
3.  "Traffic Info"

First, the traffic bulletins for the calculated route are displayed.

The traffic bulletins are sorted in the order of their distance from the current vehicle position.

4. Select a traffic bulletin.
 "More information":
Display additional information.
5. Scroll to the next or previous traffic bulletin if desired.

Traffic bulletins on the map

"Traffic conditions/gray map" active: the Control Display changes to a grayscale display. This enables a better view of the traffic bulletins. The day/night mode is disregarded in this setting. Symbols or special destinations are no longer displayed.

1. "Navigation"
2. "Map"
3. Open "Options".
4. "Settings"
5. "Traffic conditions/gray map"

Symbols in the map view

Depending on the scale of the map and the location of the traffic obstruction along the route, the symbols for the traffic obstructions are displayed.

Additional information in the map view

Depending on the map scale, a traffic obstruction's length, direction and impact are displayed on the map using triangles or gray bars along the calculated route.

- ▷ Red: traffic congestion
- ▷ Orange: stop-and-go traffic
- ▷ Yellow: heavy traffic
- ▷ Green: clear roads
- ▷ Gray: general traffic information, e.g. construction zone

The bulletins displayed depend in the respective traffic information service.

Filtering traffic bulletins

Set which traffic bulletins are displayed on the map.

1. "Navigation"
2. "Map"
3. Open "Options".
4. "Traffic Info categories"
5. Select the desired categories.

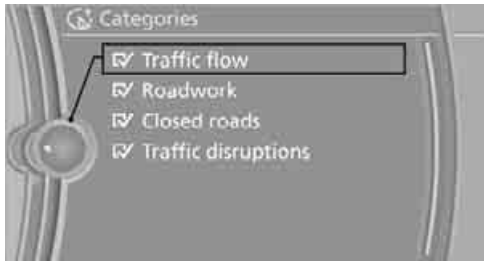

Traffic bulletins from the selected categories are displayed on the map.

- ▷ Traffic bulletins that lie on the route are always shown.
- ▷ For your personal safety, it is not possible to hide traffic bulletins that announce a potential hazard.

Route guidance with traffic bulletins

Semi-dynamic route guidance

With traffic bulletin reception switched on, semi-dynamic route guidance is active.

The system takes into account the existing traffic bulletins during route guidance. A message is displayed as a function of the route, the traffic bulletins, and the possible alternate routes. In the event of a traffic obstruction, an alternate route will be suggested if possible.

The upper part of the message shows:

- ▷ The symbol of the first traffic obstruction, possibly with the remaining distance before the start of the traffic obstruction.
- ▷ Total length of traffic obstructions on the route.
- ▷ Extension of driving time due to the traffic obstructions

The lower part of the message shows:

- ▷ Suggested alternate route with remaining distance before the start of the alternate route.
- ▷ Difference of the route length compared to the original route.
- ▷ Time gained by taking the alternate route compared to the original route with the traffic obstructions.



In addition to the original route displayed in white, the split screen will also show the alternate route.

Taking an alternate route:

📍 "Detour"

With particular hazards, e.g. objects on the roadway, a message is displayed without a possible alternate route.

It is also possible to take alternate routes can also be taken if the traffic reports are accessed via the list:

1. "Navigation"
2. "Map"
3.  "Traffic Info"
4. "Detour information"
5.  "Detour"

Dynamic destination guidance

The route is automatically changed in the event of traffic obstructions.

- ▷ The system does not point out traffic obstructions along the original route.
- ▷ Traffic bulletins will continue to be displayed on the map.
- ▷ Depending on the type of road and the nature and length of the traffic obstruction, the route can also be calculated so that you travel through the traffic obstruction.
- ▷ Certain hazards are displayed regardless of the setting.

To activate dynamic route guidance:

1. "Navigation"
2. Open "Options".
3. "Dynamic guidance"

What to do if ...

Vehicle equipment

In this chapter, all production, country, and optional equipment that is offered in the model range is described. Equipment is also described that is not available because of, for example, selected options or country version. This also applies to safety related functions and systems.

The area has not been fully recorded yet, or you have left the recommended route and the system requires a few seconds to calculate a new route suggestion.

What to do if...

- ▷ The current position cannot be displayed?
The position is in an unrecognized region, in a poor reception area, or the system is in the process of determining the position. Reception is generally available when you are in the open.
- ▷ The destination guidance does not accept a destination without a street name?
A downtown area cannot be determined for the town or city that has been entered. Input any street in the selected town/city and start destination guidance.
- ▷ The destination guidance does not accept a destination?
The destination data is not contained in the navigation data. Choose a destination as close as possible to the original one.
- ▷ The letters for a destination cannot be selected during destination entry?
The stored data do not contain the data of the destination. Select a destination that is as close as possible to the original.
- ▷ The map view is displayed in grayscale?
"Traffic conditions/gray map" active: the Control Display changes to a grayscale display. This enables a better view of the traffic bulletins.
- ▷ Voice instructions are no longer issued before intersections during destination guidance?



Entertainment

Operation of the radio, CD equipment and external audio devices as well as their tone settings are described in this chapter.

On/off and tone

Vehicle equipment

In this chapter, all production, country, and optional equipment that is offered in the model range is described. Equipment is also described that is not available because of, for example, selected options or country version. This also applies to safety related functions and systems.

General information

The following audio and video sources share the same control elements and adjustments:

- ▷ Radio
- ▷ CD/DVD player
- ▷ Video
- ▷ External devices, e.g. MP3 player



Controls

The audio and video sources can be controlled using the:

- ▷ Buttons near the CD/DVD player
- ▷ iDrive
- ▷ Buttons on the steering wheel, refer to page 13
- ▷ Programmable memory keys, refer to page 25
- ▷ Voice activation system

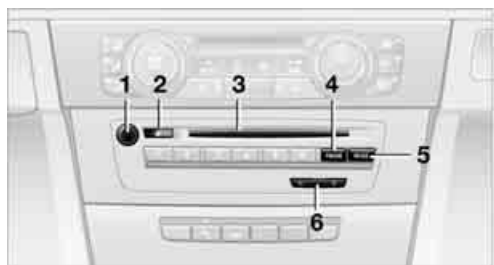
Buttons near the CD/DVD player



- 1 Sound output for entertainment on/off, volume
 - ▷ Press: switch on/off
When you switch on the unit, the last set radio station or track is played.
 - ▷ Turn: adjusting the volume
- 2  Eject the CD/DVD
- 3 CD/DVD drive
- 4 **FM/AM**: change the radio station waveband
- 5 **MODE**: change the audio and video sources
- 6  Station scan/track search
 - ▷ Change the radio station
 - ▷ Select the track for the CD/DVD player and certain multimedia devices

Switching on/off

To switch the entertainment audio output on or off:

Press knob 1 next to the CD/DVD player.

 This symbol on the Control Display indicates that sound output is switched off.

The sound output is available for approx. 20 minutes after the ignition was switched off. For sound output, switch the unit back on.

Adjusting volume

Turn knob 1 next to the CD/DVD player until the desired volume is obtained.

You can also adjust the volume with buttons on the steering wheel, refer to page 13.

Setting tone controls

You can alter various tone settings, e.g. treble and bass or the speed-dependent volume increase.

The tone settings are set for all audio sources at once.

The settings are stored for the remote control currently in use.

Treble, bass, balance, fader

- ▷ "Treble": treble adjustment.
- ▷ "Bass": bass adjustment.
- ▷ "Balance": left/right volume distribution
- ▷ "Fader": front/rear volume distribution

Adjustments

1. "CD/Multimedia", "Radio" or "Settings".
2. "Tone"



3. Select the desired tone setting.



4. To adjust: turn the controller.
5. To store: press the controller.

Equalizer

You can set individual sound frequency ranges.

1. "CD/Multimedia", "Radio" or "Settings".
2. "Tone"
3. "Equalizer"
4. Select the desired setting.

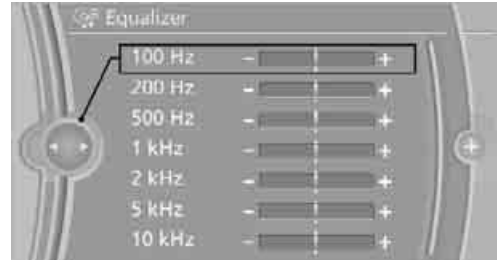

5. To adjust: turn the controller.
6. To store: press the controller.

Multi-channel playback, surround

You can choose between stereo and multi-channel playback, surround.

1. "CD/Multimedia", "Radio" or "Settings".
2. "Tone"
3. "L7 Surround"



When surround is activated, multi-channel playback is simulated when playing an audio track in stereo.

LOGIC7 and the LOGIC7 logo are registered trade marks of Lexicon, Inc., a company of the Harman International Group.

Volume

- ▷ "Speed volume": the volume is adapted depending on the speed.
- ▷ "PDC": the volume of the PDC acoustic signal relative to the entertainment sound output.
- ▷ "Gong": the volume of the acoustic signal, e.g. for the acoustic Safety Belt Reminder relative to the entertainment sound output.
- ▷ "Microphone": volume of the microphone during a phone conversation.
- ▷ "Loudspeak.": volume of the speaker during a phone conversation.

Adjustments

1. "CD/Multimedia", "Radio" or "Settings".
2. "Tone"
3. "Volume settings"
4. Select the desired volume setting.

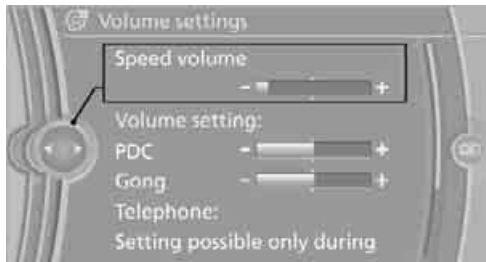

5. To adjust: turn the controller.
6. To store: press the controller.

Resetting tone settings

You can reset all tone settings to the default setting.

1. "CD/Multimedia", "Radio" or "Settings".
2. "Tone"
3. "Reset"

Radio

Vehicle equipment

In this chapter, all production, country, and optional equipment that is offered in the model range is described. Equipment is also described that is not available because of, for example, selected options or country version. This also applies to safety related functions and systems.

General information

Your radio is designed for reception of the following stations:

- ▷ FM and AM
- ▷ HD Radio
- ▷ Satellite radio

Selecting a station



Press the knob if the sound output is switched off.

1. "Radio"

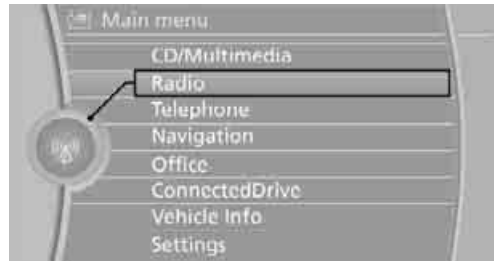

2. "FM" or "AM"

3. Select the desired station.

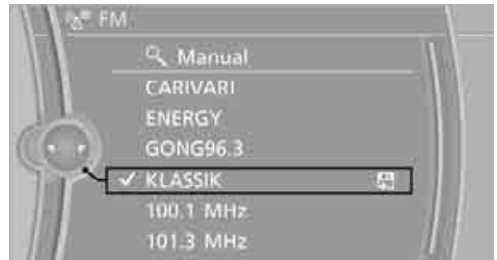

The selected station is stored for the remote control currently in use.

Changing stations

Turn the controller and press it

or

Press the  button for the corresponding direction

or

Press the buttons on the steering wheel, refer to page 13.

Selecting a station manually

Station selection via the frequency.

1. "Radio"
2. "FM" or "AM"
3. "Manual"
4. Select the frequency: turn the controller.



To store the station: press the controller for an extended period.

Renaming a radio station

An FM station with changing station names can be renamed.

1. "Radio"
2. "FM"
3. Select the desired station.
4. Open "Options".
5. "Rename to:"

If necessary, wait until the desired name appears.

The selected station name is added to the list of current stations and stored stations.

Storing stations

Via iDrive

1. "Radio"
2. "FM" or "AM"
3. Select the desired station.

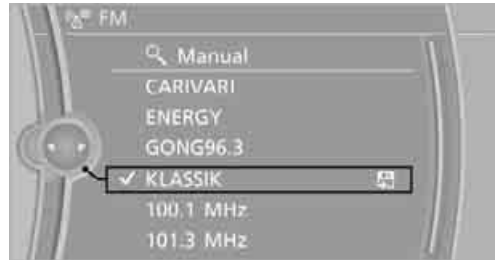

4. Press the controller for an extended period.
5. Select the desired memory location.

The stations are stored for the remote control currently in use.

Via programmable memory keys

You can store a station on the programmable memory keys, refer to page 25.

1. Select a station.
2.  Press and hold the desired button.

RDS – Radio Data System

In the FM waveband, additional information is transmitted via RDS. If the reception conditions are good, the station names are shown on the Control Display. If the reception is weak or disrupted, it can take some time before the station names are displayed.

Switching the RDS on/off

1. "Radio"
2. "FM"
3. Open "Options".
4. "RDS"



The setting is stored for the remote control currently in use.

HD Radio™ reception

Many radio stations transmit analog and digital signals.

License conditions

HD radio technology manufactured under license from iBiquity Digital Corporation. U.S. and foreign patents. HD Radio™ and the HD, HD Radio, and Arc logos are proprietary trademarks of iBiquity Digital Corp.

Switching digital radio reception on/off

1. "Radio"
2. "FM" or "AM"
3. Open "Options".
4. "HD Radio Reception"

The setting is stored for the remote control currently in use.

HD This symbol is displayed when a station is being received digitally.

When setting a station that has a digital signal, it may take several seconds before the station plays in digital quality.

Instructions for HD stations whose station name ends with ...HD or ...HD1:

In areas in which the station is not continuously received in digital mode, playback switches between analog and digital reception. In this case, switch off digital radio reception.

Instructions for HD multicast stations whose station name ends with ...HD2 or ...HD3:

In areas in which the station is not continuously received in digital mode, interruptions in the audio signal may occur, which can last for several seconds. This depends on the reception.

Displaying additional information

Some stations broadcast additional information on the current track, such as the name of the artist.

1. Select the desired station.
2. Open "Options".
3. "Station info"

Selecting a substation

The symbol indicates that a main station also broadcasts additional substations. The station name of the main station ends in HD1. The station names of the substations end in HD2, HD3, etc.

1. Select the desired station.
2. Press the controller.
3. Select the substation.

When reception is poor, the substation is muted for several seconds.

Presets

It is possible to store up to 40 stations.

Selecting a station

1. "Radio"
2. "Presets"
3. Select the desired station.

Storing stations

The station currently selected is stored.

1. "Radio"
2. "Presets"
3. "Store station"



4. Select the desired memory location.

The list of stored stations is stored for the remote control currently in use.

You can also store the stations on the programmable memory keys, refer to page [25](#).

Deleting a station

1. "Radio"
2. "Presets"
3. Select the desired station.
4. Open "Options".
5. "Delete entry"

Satellite radio







Vehicle equipment

In this chapter, all production, country, and optional equipment that is offered in the model range is described. Equipment is also described that is not available because of, for example, selected options or country version. This also applies to safety related functions and systems.

General information

The channels are offered in fixed packages. Packages must be activated by telephone.

Navigation bar

Symbol	Function
	Changing list view
	Selecting category
	Entering channel directly
	Time shift
	Accessing favorites, selecting the My Favorites category
	Managing favorites
	Traffic Jump

The functions of the navigation bar symbols can also be stored on the programmable memory buttons, refer to page 25.

Managing subscription

Clear reception is required for activating and deactivating channels. Reception is best when you have an unobstructed view to the sky. The channel name is displayed in the status line.

Activating channels

The "Unsubscribed Channels" category contains all disabled channels.

1. "Radio"
2. "Satellite radio"
3.  "Category"



4. Select the "Unsubscribed Channels" category.
5. Select desired channel.
The telephone number and electronic serial number, ESN, are displayed.
6. Dial the telephone number to have the channels activated.

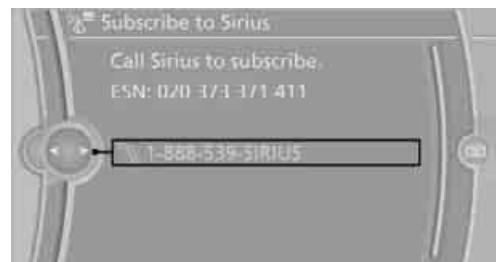

This telephone number can also be used to deactivate the channels.

Deactivating channels

1. "Radio"
2. "Satellite radio"
3. Open "Options".
4. "Manage subscription"



The telephone number and electronic serial number, ESN, are displayed.

5. Call Sirius to deactivate the channels.

Selecting channels

You can only listen to activated channels.

The selected channel is stored for the remote control currently in use.

Via iDrive

1. "Radio"
2. "Satellite radio"
3. Select "All channels" or the desired category.
4. Select desired channel.



Via the button in the area of the CD/DVD player

Press the  button for the corresponding direction.

The next channel is selected.

Using direct channel entry

1. "Radio"
2. "Satellite radio"
3.  "Set channel"
4. Turn the controller until the desired channel is reached and press the controller.

Storing channel

1. "Radio"
2. "Satellite radio"
3. Select "All channels" or a desired category.
4. Select desired channel.
5. Press the controller again.
6. Press the controller again to confirm the highlighted channel.



7. Select the desired memory location.



The channels are stored for the remote control currently in use.

You can also store the channels on the programmable memory keys, refer to page 25.

Changing list view

The list view changes each time the first symbol on the navigation bar is pressed.

Information about the channel is displayed.

Symbol	Function
	Channel name
	Artist
	Track

Selecting category

1. "Radio"
2. "Satellite radio"
3.  "Category"
4. Select the desired category.

Time shift

Approximately one hour of the channel currently being listened to is temporarily stored in a cache memory. Prerequisite: the signal must be available.

The stored audio track can be played back at a different time from the live broadcast. If the cache memory is full, then the older tracks are recorded over. The cache memory is deleted if a new channel is selected.





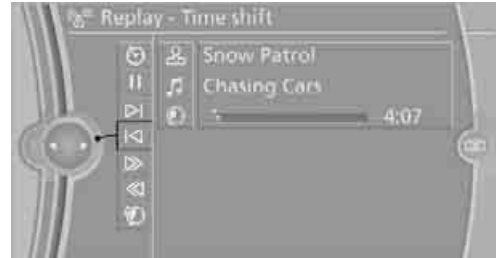

Accessing Time shift

1. "Radio"
2. "Satellite radio"
3.  "Replay - Time shift"



- ▷ The red arrow indicates the current playback position.
- ▷ The time difference from the live broadcast is displayed next to the cache memory bar.
- ▷ For live transmissions: "live".

Time shift menu

Symbol	Function
	Go to live broadcast
	Playback/pause
	Next track
	Previous track
	Fast forward
	Reverse
	Automatic time shift deactivated/activated



Automatic time shift

When the function is activated, audio playback is stopped automatically in the event of:

- ▷ Incoming and outgoing telephone calls.
- ▷ Activation of the voice activation system.
- ▷ Muting.

The audio playback then continues with a time delay.

Activating

1. "Radio"
2. "Satellite radio"
3.  "Replay - Time shift"
4.  "Automatic time shift"

Deactivating

-  "Automatic time shift"

Storing favorites

Up to 30 favorites can be stored in the favorites list. Possible favorites include artist, track, game, league, and team.

Storing artist, track, or game

Only current broadcasts can be stored as favorites. The channel information must be available.

1. "Radio"
2. "Satellite radio"
3. Select "All channels" or the desired category.
4. Select desired channel.
5. Press the controller again.
6. Select artist, track, or game.

Storing league or team

Leagues or teams can be added to the favorites from a selection list.

1. "Radio"
2. "Satellite radio"
3.  "Manage favorites"
4. "Add sports information"



5. Select the desired league.
6. Select "Add all teams" or a desired team.

Accessing favorites

If an activated favorite is being played, the message "Favorite alert!" appears for approx. 20 seconds.

Select  "Favorites" while the alert message is being displayed.



The displayed favorite will be played.

If there is no message, the system changes to the "My Favorites" category. All of the favorites currently being broadcast can be selected from a list.

Managing favorites

Activating/deactivating favorites

Favorites can be activated or deactivated globally and individually.

1. "Satellite radio"
2. ☆+ "Manage favorites"
3. Select "Activate alert" or desired favorites.

The setting is stored for the remote control currently in use.

Deleting favorites

1. "Satellite radio"
2. ☆+ "Manage favorites"
3. Highlight the favorites you wish to delete.
4. Open "Options".
5. "Delete entry"

Traffic Jump

Traffic and weather information for a selected region are broadcast at intervals of a few minutes.

Selecting region

1. "Radio"
2. "Satellite radio"
3. Open "Options".
4. "Set jump"
5. Select the desired region.

The region is stored for the remote control currently in use.



Activating/deactivating Jump

1. "Radio"
2. "Satellite radio"
3. ↶ "Jump to:"

As soon as information about the selected region becomes available, it is broadcast.

A new panel appears in the display.

Cancel Traffic Jump: "Cancel".

Symbol	Meaning
	Information will be broadcast soon.
	Information is currently being broadcast.

Select one of the symbols to deactivate Traffic Jump.

Automatic update

About twice a year, Sirius carries out an update of the names and positions of the channels. The update occurs automatically and can take several minutes.

Notes

- ▷ Under some circumstances, reception may not be possible, e.g. under certain environmental or topographical conditions. The satellite radio has no influence on this.
- ▷ The signal may not be available in tunnels or underground garages or near trees, mountains, or other powerful sources of radio interference.

CD/DVD player

Vehicle equipment

In this chapter, all production, country, and optional equipment that is offered in the model range is described. Equipment is also described that is not available because of, for example, selected options or country version. This also applies to safety related functions and systems.

CD/DVD playback



Inserting a CD/DVD

Insert the CD/DVD into the drive with the labeled side facing up. The CD/DVD is drawn in automatically.

Playback starts automatically if the sound output is on. For CDs/DVDs with compressed audio files, it can take several minutes to read in the data, depending on the directory structure.

Playable formats

CD/DVD player

- ▷ DVD: DVD-ROM, DVD-R, DVD+R, DVD-RW, DVD+RW, DVD-R DL, DVD+R DL, DVD audio (video part only), DVD video
- ▷ CD: CD-ROM, CD-R, CD-RW, CD-DA
- ▷ Compressed audio files: MP3, WMA, AAC, M4A

Starting playback

A CD/DVD is in the CD/DVD player.

1. "CD/Multimedia"
2. "CD/DVD"
3. Select the desired CD or DVD:

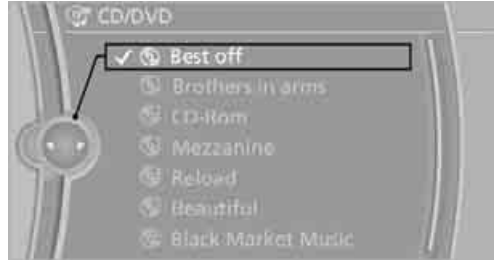

Symbol	Meaning
	CD/DVD player

Ejecting a CD/DVD

Press the button next to the CD/DVD player. The CD/DVD emerges slightly from the drive.

Audio playback

Selecting the track using the button

Press the button for the appropriate direction as often as necessary until the desired track is reached.

Selecting a track using iDrive

Audio CDs

1. "CD/Multimedia"
2. "CD/DVD"
3. Select the desired CD or DVD.

4. Select the desired track to begin playback.



CDs/DVDs with compressed audio files

Depending on the data, some letters and numbers of the CD/DVD may not be displayed correctly.

1. "CD/Multimedia"
2. "CD/DVD"
3. Select the desired CD or DVD.
4. Select the directory, if necessary.
To change to a higher level directory: move the controller to the left.



5. Select a track and press the controller.



Displaying information about the track

If information about a track has been stored, it is displayed automatically:



- ▷ Artist
- ▷ Album title
- ▷ Number of tracks on the CD/DVD
- ▷ Track file name

Random sequence playback

The tracks on the current CD/DVD are played once in random sequence.

1. "CD/Multimedia"
2. "CD/DVD"
3. Select the desired CD or DVD.
4. Open "Options".
5. "Random"

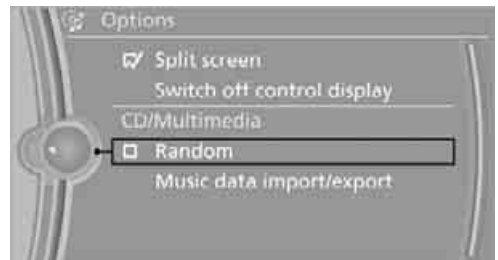

CDs/DVDs with compressed audio files: all the tracks in the selected directory are played in random sequence.

Random mode is switched off when the audio source is changed or the ignition is switched off.

Fast forward/reverse

Press and hold the  button for the corresponding direction.

Video playback

Country codes

Only DVDs with the code of the home region can be played back; also refer to the information on your DVD.

Code	Region
1	USA, Canada
2	Japan, Europe, Middle East, South Africa
3	Southeast Asia
4	Australia, Central and South America, New Zealand
5	Northwest Asia, North Africa
6	China
0	All regions

Starting playback

For your own safety, the video image is only displayed up to approx. 2 mph/3 km/h and in some market-specific versions, only with the parking brake engaged or the selector lever of the automatic transmission is in the park position.

DVD video

1. "CD/Multimedia"
2. "CD/DVD"
3. Select a DVD with video content.

4. "DVD menu"



5. Start the DVD via the DVD menu.

VCD/SVCD

1. "CD/Multimedia"
2. "CD/DVD"
3. Select a CD/DVD with video content.
4.  "Select track"
5. Select the desired track.









The CD/DVD is started.

Video menu

To open the Video menu:

1. Turn the controller during playback.
2. Press the controller when "Back" is displayed.

The Video menu is displayed:

Symbol	Function
	Open the DVD menu
	Starting playback
	Pause
	Stop
	Next chapter/next track
	Previous chapter/previous track
	Fast forward
	Reverse

In fast forward/reverse: the speed increases every time the controller is pressed. To stop, start playback.

DVD menu

1. If necessary, turn the controller to open the Video menu.
 2. **DVD** "DVD menu"
The DVD menu is displayed. The display depends on the contents of the DVD.
- ▷ To select menu items: move and press the controller.
 - ▷ To change to the Video menu: turn the controller and select "Back".

DVD/VCD settings

For some DVDs, settings can only be made via the DVD menu; also refer to the information on your DVD.

Language

1. Turn the controller during playback.
2. Open "Options".
3. "Audio/language"



4. Select the desired language.

The languages that are available depend on the DVD.

Subtitles

Subtitles can be selected if they are contained on the DVD.

1. Turn the controller during playback.
2. Open "Options".
3. "Subtitles"
4. Select the desired language or "Do not display subtitles".



Brightness, contrast, color

1. Turn the controller during playback.
2. Open "Options".
3. "Display settings"
4. "Brightness", "Contrast" or "Color"



5. Turn the controller until the desired setting is displayed, and then press the controller.

Zoom

Display the video image on the full screen.

1. Turn the controller during playback.
2. Open "Options".
3. "Additional options"
4. "Zoom mode"

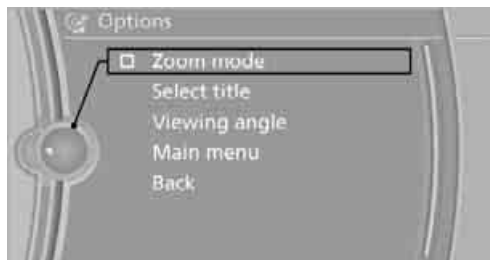

Selecting track

DVD video:

1. Turn the controller when the DVD menu is displayed.
2. Open "Options".
3. "Additional options"
4. "Select title"
5. Select the desired track.

VCD/SVCD:

1.  "Select track"
2. Select the desired track.

Camera angle

The camera angle depends on the DVD.

1. Turn the controller during playback.
2. Open "Options".
3. "Additional options"
4. "Viewing angle"
5. Select the desired camera angle.

Opening the main menu, back

These functions are not contained on every DVD. Therefore, they may not be available for use.

Notes



BMW CD/DVD players are officially designated Class 1 laser products. Do not operate if the cover is damaged; otherwise, severe eye damage can result.

Do not use self-recorded CDs/DVDs with labels applied as these can become detached during playback due to heat build-up and can cause irreparable damage to the device.

Only use round CDs/DVDs with a standard diameter of 4.7 in/12 cm and do not play CDs/DVDs with an adapter, e.g. CD singles; otherwise, the CDs or the adapter might jam and no longer eject.

Do not use a combined CD/DVD, e.g. DVD^{Plus}; otherwise, the CD/DVD can jam and will no longer eject. ◀

General malfunctions

BMW CD/DVD players have been optimized for performance in vehicles. In some instances they may be more sensitive to faulty CDs/DVDs than stationary devices would be.

If a CD/DVD cannot be played, first check if it has been inserted correctly.

Humidity

High levels of humidity can lead to condensation on the CD/DVD or the laser's scan lens and temporarily prevent playback.

Malfunctions with individual CDs/DVDs

If malfunctions occur only with particular CDs/DVDs, this may be due to one of the following reasons

Self-recorded CDs/DVDs

Possible reasons for malfunctions with self-recorded CDs/DVDs are, for example, inconsistent data-creation or recording processes, or poor quality or old age of the CD/DVD blank.

Only label CDs/DVDs on the top, with a pen designed for this purpose.

Damage

Avoid leaving fingerprints, as well as dust, scratches or moisture on the CDs/DVDs. Keep CDs/DVDs in protective sleeves or cases. Do not subject CDs/DVDs to temperatures above 122 °F /50 °C, nor to high humidity levels or direct sunlight.

CDs/DVDs with copy protection

CDs/DVDs are often copy-protected by the manufacturer. This can mean that some CDs/DVDs cannot be played or can only be played to a limited extent.

MACROVISION

This product contains copyrighted technology that is based on multiple registered U.S. patents and the intellectual property of the Macrovision Corporation and other manufacturers. The use of this copy protection must be approved by Macrovision. Unless otherwise agreed with Macrovision, media with this protection may only be used for private purposes. Copying of this technology is prohibited.

DTS Digital Surround™



Manufactured under license of US patent numbers: 5,451,942; 5,956,674; 5,974,380; 5,978,762; 6,487,535 & other patents granted and pending in both the USA and worldwide. DTS and the logo are registered trademarks & DTS Digital Surround and the DTS logos are trademarks of DTS Inc. © DTS, Inc. All rights reserved.

Music collection

Vehicle equipment

In this chapter, all production, country, and optional equipment that is offered in the model range is described. Equipment is also described that is not available because of, for example, selected options or country version. This also applies to safety related functions and systems.

Storing music

The music tracks from CDs, DVDs and USB devices can be stored in the music collection in the vehicle and played from there.

- ▷ Audio CD: tracks are converted into a compressed audio format when they are stored. If available, information on the album, such as the artist, is stored as well.
- ▷ CD/DVD or USB device with compressed audio files: the entire content of the CD/DVD or the USB device is stored in the vehicle as an album. After storing, the tracks and directories can be deleted individually. Files are only stored in the WMA, MP3, M4A, and AAC formats.

Tracks with DRM copy protection can be stored in the vehicle but cannot be played back.

 Regularly back up the music data; otherwise, it could be lost if there is a fault on the hard disc. ◀

 Music recognition technology and related data are provided by Gracenote®. Gracenote® is the industry standard in music recognition technology and related content delivery. For more information, please visit www.gracenote.com.

CD and music-related data from Gracenote, Inc., copyright © 2000-2009 Gracenote. Gracenote Software, copyright © 2000-2009 Gracenote. This product and service may prac-

tice one or more of the following U.S. Patents: 5.987.525, 6.061.680, 6.154.773, 6.161.132, 6.230.192, 6.230.207, 6.240.459 and 6.330.593 as well as other granted or pending patents. Some services supplied under license from Open Globe, Inc. for U.S. Patent: 6.304.523.

Gracenote and CDDB are registered trademarks of Gracenote. The Gracenote logo and logotype, and the "Powered by Gracenote" logo are trademarks of Gracenote.

Storing files from CDs/DVDs

CDs/DVDs can only be stored from the CD/DVD player.

1. Insert a CD/DVD into the CD/DVD player.
2. "CD/Multimedia"
3. "CD/DVD"
4. Select the  symbol for the CD/DVD player.
5. "Store in vehicle"



The music collection is displayed. The tracks are stored and played back in sequence from the music collection.

Observe the following during the storage process:

Do not switch back to the CD/DVD player and do not remove the CD/DVD from the CD/DVD player; otherwise, the storage process will be interrupted.

You can switch to the other audio sources without interrupting the storage process. Tracks from the current CD/DVD can also be called up, if they have been stored already.

Interrupting storage

1. "CD/Multimedia"
2. "CD/DVD"
3. "Storing..."



4. "Cancel storing"

The storage process is interrupted and can be continued at any time.

Continuing the storage process

1. "CD/Multimedia"
2. "CD/DVD"
3. Select the  symbol for the CD/DVD player.
4. "Continue storing"

The storing of the CD/DVD continues at the beginning of the track at which storing was interrupted.

Album information

During storage, information such as the name of the artist is stored with the track, if this information is available in the vehicle database or on the CD.

To update the database, contact your service center.

Storing from a USB device

To store music, a suitable device must be connected to the USB interface in the glove compartment.

- ▷ Suitable devices: USB mass storage devices, such as USB flash drives or MP3 players with a USB interface.
- ▷ Unsuitable devices: USB hard drive, USB hubs, USB memory card readers with multiple inserts, Apple iPod/iPhone. Music from Apple iPods/iPhones can be played via the USB audio interface in the center armrest.
- ▷ File systems: popular file systems for USB devices are supported. The format FAT 32 is recommended.

 Music from a USB device can be stored only via the USB interface in the glove compartment. ◀

1. Connect the USB device to the USB interface in the glove compartment.
2. "CD/Multimedia"
3. "Music collection"
4. Open "Options".
5. "Music data import/export"
6. "Import music (USB)"



Playing music

Music search

All tracks for which additional information has been stored can be accessed by the music search. Tracks without additional information can be called up via the corresponding album.

1. "CD/Multimedia"
2. "Music collection"
3. "Music search"



4. Select the desired category.



5. To select the desired entry:
 - ▶ Open "A-Z search" and enter the desired input.
 or
 - ▶ Select the desired entry from the list.
6. Select additional categories if desired. The tracks found are listed in alphabetical order. Not all categories need to be selected. For example, to search for all tracks by a certain artist, call up that artist only. All of the tracks by that artist are then displayed.
7. "Start play"
The list of tracks is automatically repeated.

Restarting the music search

"New search"

Music search by voice

For instructions on the voice activation system, refer to page 27.

1. Press the  button on the steering wheel.
2. ›Music search‹
3. Open the desired category, e.g. ›Select artist‹.
4. Say the desired entry in the list.
5. Select additional categories if desired.

To select a track directly:

 ›Title ...‹

Say the voice command and the name of the desired track in one command.

Current playback

The list of tracks that was generated last by the music search or the album selected last.

1. "CD/Multimedia"
2. "Music collection"
3. "Current playback"



4. Select the desired track, if necessary.



Top 50

List of the 50 most frequently played tracks.

1. "CD/Multimedia"
2. "Music collection"
3. "Top 50"
4. Select the desired track, if necessary.

Albums

All stored albums, listed in order of their storage dates. Symbols indicate the format.

Symbol	Format
	Audio CD
	Compressed audio files

1. "CD/Multimedia"
2. "Music collection"
3. Select the desired album.



Depending on the album, the tracks or the subdirectories of the album are displayed. The first track is played automatically, if possible.

4. To select tracks, change directories if needed. To go up one level in the directory, move the controller to the left.

Random sequence playback

All tracks of the selection are played back in random sequence.

1. "CD/Multimedia"
2. "Music collection"
3. Open "Options".
4. "Random"



Managing music

Albums

Renaming an album

The name of the album, if available, is automatically entered when the album is stored. If the name is unknown, it can be changed later.

An album cannot be renamed while a track from that album is being played.

1. "CD/Multimedia"
2. "Music collection"
3. Highlight the desired album.
4. Open "Options".
5. "Rename album"



6. Select the letters individually.

Deleting an album

An album cannot be deleted while a track from it is being played.

1. "CD/Multimedia"
2. "Music collection"
3. Highlight the desired album.
4. Open "Options".
5. "Delete album"

Deleting a track and directory

A track cannot be deleted while it is being played.

A directory cannot be deleted while a track from it is being played.

1. "CD/Multimedia"
2. "Music collection"
3. Highlight the directory or track.
4. Open "Options".
5. "Delete folder" or "Delete track".

Free memory capacity

Display the free memory capacity in the music collection.

1. "CD/Multimedia"
2. "Music collection"
3. Open "Options".
4. "Free memory"

Music collection

Backing up the music collection

The entire music collection can be stored on a USB medium. Make sure there is enough free memory capacity on the USB device.

Depending on the number of tracks, backing up the music collection may take several hours. Therefore, it is best to perform the backup during a long trip.

1. Start the engine.
2. Connect the USB medium to the USB interface in the glove compartment, refer to page 124.
3. "CD/Multimedia"
4. "Music collection"
5. Open "Options".

6. "Music data import/export"

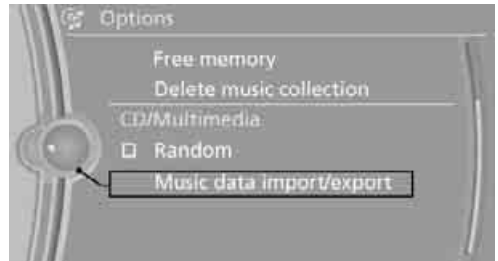

7. "Backup music on USB"



Restoring the music collection in the vehicle

 When storing from the USB device, the music collection existing in the vehicle is replaced. ◀

1. "CD/Multimedia"
2. "Music collection"
3. Open "Options".
4. "Music data import/export"
5. "Restore music from USB"

Deleting the music collection





1. "CD/Multimedia"
2. "Music collection"
3. Open "Options".
4. "Delete music collection"

External devices

Vehicle equipment

In this chapter, all production, country, and optional equipment that is offered in the model range is described. Equipment is also described that is not available because of, for example, selected options or country version. This also applies to safety related functions and systems.

Overview

Symbol	Meaning
	AUX-In connection
	USB audio interface
	Music interface for smartphones
	Bluetooth audio

AUX-IN port

Overview

- ▷ It is possible to connect audio devices, e.g. MP3 players. Sound is output over the vehicle speakers.
- ▷ Recommended settings: mid-level tone and volume settings on the audio device. Tone may depend on the quality of the audio files.

Connecting

Lift up the center armrest.



Connection for audio playback:
TRS connector 1/8 in/3.5 mm

The AUX-In connection is in the center armrest. Connect the headphone connection or line-out connection of the device to the jack plug.

Playback

1. Connect the audio device, switch it on, and using the audio device, select a track.
2. "CD/Multimedia"
3. "External devices" if applicable
4.  "AUX front"

Sound is output over the vehicle speakers.

Volume

The volume of the sound output depends on the audio device. If this volume differs markedly from the volume of the other audio sources, it is advisable to adjust the volumes.

Adjusting volume

1. "CD/Multimedia"
2. "External devices" if applicable
3.  "AUX front"
4. "Volume"

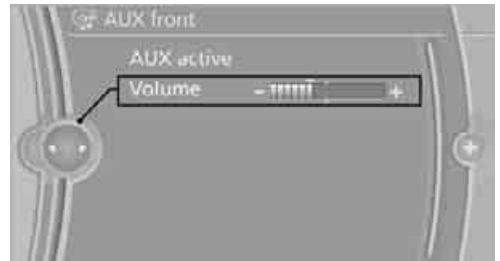

5. Turn the controller until the desired volume is set and then press the controller.

USB audio interface/Music interface for smartphones

Overview

It is possible to connect external audio devices. They can be operated via iDrive. Sound is output over the vehicle speakers.

Options for connecting external devices

- ▷ Connection via USB audio interface: Apple iPod/iPhone, USB devices, e.g. MP3 player, USB flash drive, or mobile phones that are supported by the USB audio interface.
- ▷ Connection via snap-in adapter if the vehicle is equipped with a music interface for smartphones: Apple iPhone or mobile phones.
Playback may only be possible when no device is connected to the AUX-IN port.

Because of the large number of audio devices available on the market, an operation via the vehicle cannot be guaranteed for every audio device/mobile phone.

Ask your BMW center for suitable audio devices/mobile phones.

File systems

Popular file systems for USB devices are supported. The format FAT 32 is recommended.

Audio files

Playback of standard audio files is possible:

- ▷ MP3
- ▷ WMA
- ▷ WAV (PCM)
- ▷ AAC, M4A
- ▷ Playback lists: M3U, WPL, PLS

Connection via the USB audio interface

Lift up the center armrest.



- 1 AUX-IN port for audio playback: TRS connector 1/8 in/3.5 mm
- 2 USB interface

Apple iPod/iPhone

Use a flexible adapter cable for the connection. Connect the Apple iPod/iPhone to the USB interface **2**.

The Apple iPod/iPhone menu structure is supported by the USB audio interface.

USB device

To protect the USB interface and USB device from mechanical damage, connect them with a flexible adapter cable.

Connect the USB device to the USB interface **2**.

After initial connection

Information about all tracks, e.g. artist or music style and the playlists are imported into the vehicle. It can take some time, depending on the USB device and the number of tracks.

During transmission, the tracks can be accessed via the file directory.



Number of tracks

The data from up to four USB devices or for approx. 36,000 tracks can be stored in the vehicle. If a fifth device is connected or if more than 36,000 tracks are stored, then the data of existing tracks may be deleted.

Copy protection

Music tracks with integrated Digital Rights Management (DRM) cannot be played.

Playback

1. "CD/Multimedia"
2. "External devices"
3. Select the  or  symbol.



Playback begins with the first track.

The CD cover that belongs to the track appears on the Control Display, possibly after a few seconds.



Track search

Selection is possible via:

- ▷ Playback lists
- ▷ Information: music style, artist; if applicable, composer, album, track.
- ▷ Additionally for USB devices: file directory; if applicable, composer.

Track titles are displayed if they have been stored in the Latin alphabet.

Starting the track search

1. "CD/Multimedia"
2. "External devices"
3. Select the  or  symbol.
4.  "Search"
5. Select desired category, e.g. "Genre", "Artist".

All entries are displayed in a list.

- ▷ Open "A-Z search" and enter the desired input. When a letter is entered, the results are filtered using this letter as the first letter. If multiple letters are entered, all results that contain that sequence are displayed.
- ▷ Select the desired entry from the list.





6. Select additional categories if desired.
Not all categories need to be selected. For example, if all of the tracks by a certain artist are to be displayed, call up that artist only. All of the tracks by that artist are then displayed.
7. "Start play"

Restarting a track search

"New search"



Playback lists

To open playback lists.

1. "CD/Multimedia"
2. "External devices"
3. Select the  or  symbol.
4.  "Playlists"

Current playback

List of tracks currently being played.

1. "CD/Multimedia"
2. "External devices"
3. Select the  or  symbol.
4.  "Current playback"

Random play sequence

The current list of tracks is played in random sequence.

1. "CD/Multimedia"
2. "External devices"
3. Open "Options".
4. "Random"

Fast forward/reverse

Press and hold the  button.



Video playback

Overview



Video playback possible via snap-in adapter. They can be operated via iDrive. Sound is output over the vehicle speakers.

Playback

For your own safety, the video image is only displayed up to approx. 2 mph/3 km/h and in some market-specific versions, only with the parking brake engaged or the selector lever of the automatic transmission is in the park position.

1. "CD/Multimedia"
2. "External devices"
3. Select the  symbol.
4.  "Video"
5. Select the directory, if necessary.
To change to a higher level directory: move the controller to the left.
6. Select the desired video file to begin playback.

Video menu

Symbol	Format
	Next video file
	Previous video file
	It may be necessary to click the symbol twice in order to play the previous video file.

Notes

Do not expose the audio device to extreme environmental conditions, e.g. very high temperatures, refer to the operating instructions of the audio device.

Depending on the configuration of the audio files, e.g. bit rates greater than 256 Kbit/s, proper playback cannot always be ensured.

Information on connection

- ▷ The connected audio device is supplied with a max. power of 500 mA if supported by the device. For this reason, do not connect the device to a charging socket in the vehicle; otherwise, it may not be possible to ensure proper playback.
- ▷ Do not use force when plugging the connector into the USB interface.
- ▷ Do not connect devices such as fans or lamps to the USB audio interface.
- ▷ Do not connect USB hard drives.
- ▷ Do not use the USB audio interface to recharge external devices.

Bluetooth audio

Overview

- ▷ It is possible to use Bluetooth to play music files from external devices, e.g. audio devices or mobile phones.
Using a mobile phone as an audio source, refer to page 190.
- ▷ Bluetooth® is a registered trademark of Bluetooth® SIG, Inc.
- ▷ Sound is output over the vehicle speakers.
- ▷ The volume of the sound output depends on the device. If necessary, change the volume setting on the device.
- ▷ Up to four external devices can be paired with the vehicle.

Requirements

- ▷ Suitable device. For information, go to www.bmwusa.com/bluetooth.
- ▷ Device operational.
- ▷ Ignition switched on.
- ▷ Bluetooth activated in vehicle, refer to page 201, and in the device.
- ▷ Activating Bluetooth audio, refer to page 201.
- ▷ Bluetooth presets in the device are required, e.g. connection not confirmed or visible, refer to Owner's Manual for the device.
- ▷ A number with at least 4 and at most 16 digits has been established as the Bluetooth passkey. Only required once for pairing.

Pairing and connecting

! Only pair the device when the vehicle is stopped; otherwise, inattention may lead to endangerment of passengers or other road users. ◀

1. "CD/Multimedia"
2. "Bluetooth® (audio)"
3. "Bluetooth® audio" if applicable
4. "Add new phone"

The Bluetooth name of the vehicle is displayed.



5. To perform other operations on the device, refer to the owner's manual for the device: e.g. search for and connect Bluetooth device or a new device.
The Bluetooth name of the vehicle appears on the device's display.
6. Select the Bluetooth name of the vehicle on the device's display.
You will be prompted by iDrive or the device to enter the same Bluetooth passkey.
7. Enter the passkey and confirm.

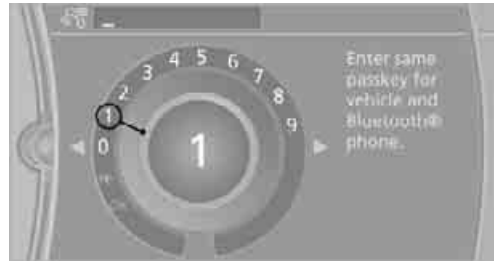

8. Select desired functions with which the device is to be connected, e.g. "Audio".
9. "OK"

If the pairing was successful, the device is displayed as connected.

🎵 symbol displayed in white: device is active as an audio source.

If the pairing was not successful: what to do if..., refer to page 195.

Connecting a particular device

A device that has already been paired can be connected as an active audio source.

Connection is not possible if a data exchange is currently taking place via a mobile phone that is connected via Bluetooth.

Prerequisite

If necessary, activate the audio connection of the desired device from the list of paired devices.

1. "CD/Multimedia"
2. "Bluetooth® (audio)"
3. "Bluetooth® audio" if applicable
4. Select the desired device from the list of paired devices.
5. Open "Options".
6. "Configure phone"
7. Activate "Audio".
8. "OK"

Connecting a device

1. "CD/Multimedia"
2. "Bluetooth® (audio)"
3. "Bluetooth® audio" if applicable
4. Select the desired device from the list of paired devices.



♪ symbol displayed in white: device is active as an audio source.

Playback

General information

- ▷ The display of track information depends on the device.
- ▷ Operation via the device or iDrive are both possible.
- ▷ Playback is interrupted if a data exchange is taking place with a mobile phone that is connected via Bluetooth.

Starting playback

1. Connect device.
2. "CD/Multimedia"
3. "External devices"
4. Select the ⓘ symbol.



5. Select the desired title from the list.

Playback menu

Depending on the device, all functions may not be available.

Symbol	Function
▷	Next track Fast forward: press and hold the symbol.
◁	Previous track Reverse: press and hold the symbol.

Disconnecting an audio connection

1. "CD/Multimedia"
2. "Bluetooth® (audio)"
3. Select the desired device from the list of connected devices.
4. Open "Options".
5. "Configure phone"
6. "Audio"
7. "OK"

With a mobile phone, only the audio connection is disconnected. All other connections remain active.

Unpairing device

1. "CD/Multimedia"
2. "Bluetooth® (audio)"
3. "Bluetooth® audio" if applicable
4. Highlight the device to be unpaired.
5. Open "Options".
6. "Remove phone from list"



What to do if...

Information about suitable devices is available at www.bmwusa.com/bluetooth.

Suitable mobile phones, refer to page 200.

- ▷ Device not supported by vehicle.
If necessary, perform a software update, refer to page 196.
- ▷ Device could not be paired or connected.
Do the Bluetooth passkeys on the device and vehicle match? Enter the same passkey on the device and via iDrive.

Is the passkey input taking longer than 30 seconds? Repeat the pairing procedure.

Are too many Bluetooth devices connected to the device or to the vehicle? If necessary, delete the connections with other devices.

Is the mobile phone in power economy mode or does it only have a small amount of battery charge remaining? Charge the mobile phone in the snap-in adapter or via a charging cable.

Depending on the mobile phone, it may only be possible to connect one device to the vehicle. Unpair the connected device from the vehicle and only pair and connect one device.

Is the device no longer responding? Switch the device off and back on again.

Repeat the pairing procedure.

- ▷ No music can be played.

Start the program for playing music files on the device and if necessary, select a track via the device.

Activate and deactivate the radio mute on the radio control panel.

- ▷ Music files only play quietly.

Adjust volume settings on the device.

- ▷ Playback is interrupted by the press of a button or other messages on the device.

Switch off key tones and other acoustic signal on the device.

- ▷ Playback is interrupted by a phone call or traffic report and does not automatically continue.

Activate and deactivate the radio mute on the radio control panel.

- ▷ Playback is not possible when the mobile phone is connected via Bluetooth audio and at the same time via the extended connectivity of the music player in the mobile phone.

Disconnect one of the two connections, e.g. the audio connection, refer to page 195, and start playback again.

If you have gone through all items in the list and still cannot activate the desired function, please contact Customer Relations or your BMW center.

Software update

The vehicle supports various external devices, depending on the software it is currently using. A software update can enable the vehicle to support, for example, new mobile phones or new external devices.

Software updates and associated, up-to-date instructions are available on the web page www.bmwusa.com/update.

Displaying current version

The currently installed software is displayed.

1. "Settings"
2. "Software update"
3. "Show current version"

Select the desired version to display additional information.

Updating software by USB

The software update can only be performed when stopped.

1. Save the file for the software update in the main directory of a USB data storage device.
2. Connect the USB data storage device to the USB audio interface in the center armrest. It is not possible to perform the update using the USB interface in the glove compartment.
3. "Settings"
4. "Software update"

5. "Update software"

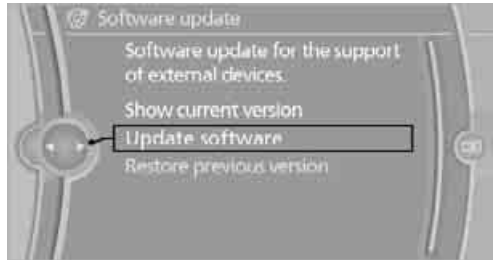

6. "Start update"

7. "OK"

All of the listed software updates are installed.

Restoring to previous version

The software version can be restored to before the last software update.

The restoring to the previous version can only be performed when stopped.

1. "Settings"
2. "Software update"
3. "Restore previous version"
4. Select "OK" twice.

All of the listed software updates are removed.

Note

BMW Assist, Office functions, and connected devices may be temporarily unavailable during a software update or while restoring to the previous version. Wait a few minutes until the functions are available once more.



Communications

This chapter describes how to use the telephone, BMW Assist and BMW TeleService.

Telephone

Vehicle equipment

In this chapter, all production, country, and optional equipment that is offered in the model range is described. Equipment is also described that is not available because of, for example, selected options or country version. This also applies to safety related functions and systems.

Overview

The concept

Mobile phones or other external devices, e.g. audio players, can be connected to the vehicle via Bluetooth.

Bluetooth® is a registered trademark of Bluetooth® SIG, Inc.

After being paired once, when the ignition is switched on, these devices are automatically detected as soon as they are present in the vehicle and can be controlled via iDrive, by the buttons on the steering wheel, and by voice.

Depending on whether they are functioning as a telephone and/or as an audio source, external devices can be used via the vehicle. The telephone functions will be described below. Operation of audio functions, refer to page 192.

Up to four external devices can be paired.

It may be necessary for some functions to be activated by the mobile phone provider or service provider.



Only make entries when traffic conditions permit. Do not hold the mobile phone in your hand while you are driving; use the hands-free system instead. Otherwise, you may endanger vehicle occupants and other road users. ◀

Snap-in adapter

The snap-in adapter makes it possible:

- ▷ Accommodate the mobile phone.
- ▷ Recharge its battery.
- ▷ Connect it to an external antenna of the vehicle.

This assures a better network connection and constant sound quality.

Suitable mobile phones

For precise information about which mobile phones and external devices with a Bluetooth interface are supported by the mobile phone preparation, go to www.bmwusa.com/bluetooth.

Displaying vehicle identification number and software part number

Checking which mobile phones are supported by the mobile phone preparation requires the vehicle identification number and software part number. The software version of the mobile phone may also be required.

1. "Telephone"
2. Open "Options".
3. "Bluetooth® info"
4. "Display system information"

With a certain software version, these suitable mobile phones support the vehicle functions described below.

With other mobile phones or software versions, malfunctions may occur.

A mobile phone that is connected to the vehicle should not be operated via the mobile phone keypad; otherwise, malfunctions may occur.

It is possible to perform a software update, refer to page 196.

Notes

At high temperatures, the charging function of the mobile phone may be limited and some functions may no longer be carried out.

When using the mobile phone via the vehicle, follow the operating instructions of the mobile phone.

Pairing/unpairing mobile phone

General information

The following functions are available:

- ▷ Using a mobile phone as a telephone.
- ▷ Using the mobile phone as an auxiliary phone.
- ▷ Using the mobile phone as an audio source.
- ▷ Using an audio device as an audio source, refer to page 192.

Requirements

- ▷ Suitable mobile phone, refer to page 200.
- ▷ Mobile phone operational.
- ▷ Bluetooth activated in vehicle, refer to page 203, and in the mobile phone.
- ▷ Bluetooth presets in the mobile phone are required, e.g. connection not confirmed or visible, refer to Owner's Manual for the mobile phone.
- ▷ Deactivating Bluetooth audio, refer to page 201.
- ▷ A number with at least 4 and at most 16 digits has been established as the Bluetooth passkey. Only required once for pairing.
- ▷ Ignition switched on.

Activating/deactivating Bluetooth link

Bluetooth is not permitted everywhere. Comply with all safety guidelines and regulations.

1. "Telephone"
2. Open "Options".
3. "Bluetooth®"

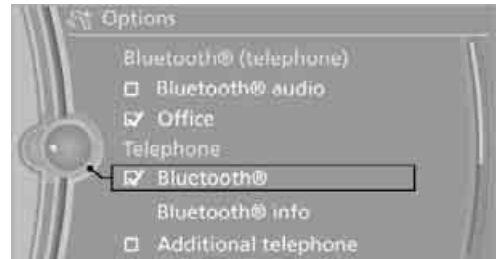

Additional functions

Auxiliary phone

A mobile phone can be used as an auxiliary phone.

Incoming calls to the auxiliary phone can be accepted, refer to page 205. Missed calls to the auxiliary phone are shown in the Control Display.

Office

Contacts, appointments, tasks, notes, text messages, and e-mails are imported from the mobile phone into the vehicle.

Audio source

A mobile phone can be used as an audio source.

Activating/deactivating additional functions

To use these functions in the vehicle, activate them before pairing. For information on suitable mobile phones that support these functions, refer to page 200.

1. "Telephone"
2. "Bluetooth® (phone)"
3. Open "Options".

4. "Configure Bluetooth®"
5. Select the desired additional function:
 - ▷ "Additional telephone"
 - ▷ "Office"
 - ▷ "Bluetooth® audio"

If an additional function is deactivated, it cannot be assigned to a phone.

Pairing and connecting a device

 Only pair the device when the vehicle is stopped; otherwise, inattention may lead to endangerment of passengers or other road users. ◀

1. "Telephone"
2. "Bluetooth® (phone)"
3. "Add new phone"

The Bluetooth name of the vehicle is displayed.



4. To perform other operations on the mobile phone, refer to the owner's manual for the device: e.g. search for and connect Bluetooth device or a new device.
The Bluetooth name of the vehicle appears on the mobile phone display.
5. Select the Bluetooth name of the vehicle on the mobile phone display.
6. You will be prompted by iDrive or the mobile phone to enter the same Bluetooth passkey.

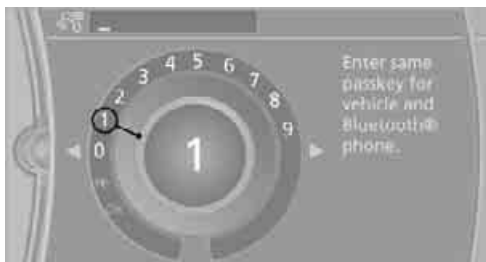

Enter the passkey and confirm.

or

Compare the control number in the vehicle's display to the control number of the mobile phone. Confirm the control number in the mobile phone and in the vehicle.

"OK"



7. Select the functions for which the mobile phone is to be used.
8. "OK"

If pairing was successful, the mobile phone appears at the top of the list of devices.

Functions supported by the mobile phone and audio device are displayed as symbols during the pairing.

White symbol: function active.

Gray symbol: function inactive.

Symbol	Function
	Telephone
	Auxiliary phone
	Audio source

Four devices can be paired with the vehicle simultaneously. Three devices can be connected to the vehicle simultaneously.

If the pairing was not successful: what to do if..., refer to page 204.

Following the initial pairing

- ▷ The mobile phone is detected/connected in the vehicle within a short period of time when the engine is running or the ignition is switched on.
- ▷ The phone book entries of the telephone that are stored on the SIM card or the mobile phone are imported into the vehicle once the device is detected, depending on the mobile phone.
- ▷ Four devices can be paired.
- ▷ Specific settings may be necessary in some mobile phones, e.g. authorization or a secure connection, refer to the Owner's Manual for the mobile phone.

Connecting a particular device

1. "Telephone"
2. "Bluetooth® (phone)"
All paired devices are listed.
3. Select the device to be connected.



The functions assigned before the unpairing of the device are assigned to the device when it is reconnected. If a device is already connected, then these functions are deactivated if necessary.

Configuring devices

Additional functions can be activated or deactivated in paired and connected devices.

1. "Telephone"
2. "Bluetooth® (phone)"
All paired devices are listed.
3. Highlight the device to be configured.

4. Open "Options".
5. "Configure phone"
6. Select the desired functions. At least one function must be selected.
 - ▷ "Telephone"
 - ▷ "Additional telephone"
 - ▷ "Audio"



7. "OK"

If a device is assigned a function, this may deactivate the function in an already connected device and cause the other device to be unpaired.

Exchanging the telephone and auxiliary phone

If the telephone and auxiliary phone are connected to the vehicle, the function can be swapped between the two devices.

1. "Telephone"
2. "Bluetooth® (phone)"
All paired devices are listed.
3. "Swap phone/addit. phone"

Unpairing device

1. "Telephone"
2. "Bluetooth® (phone)"
All paired devices are listed.
3. Highlight the device to be unpaired.
4. Open "Options".

5. "Remove phone from list"

**What to do if...**

For information on suitable mobile phones, refer to page 200.

The mobile phone could not be paired or connected.

- ▷ Is Bluetooth activated in the vehicle and in the mobile phone? Activate Bluetooth in the vehicle and in the mobile phone.
- ▷ Do the Bluetooth passkeys on the mobile phone and the vehicle match? Enter the same passkey on the mobile phone and via iDrive.
- ▷ Is the passkey input taking longer than 30 seconds? Repeat the pairing procedure.
- ▷ Are too many Bluetooth devices connected to the mobile phone? If so, delete the connections with other devices on the mobile phone.
- ▷ Is the audio connection activated? Deactivate the audio connection.
- ▷ Is the mobile phone in power economy mode or does it only have a small amount of battery charge remaining? Charge the mobile phone in the snap-in adapter or via a charging cable.
- ▷ Depending on the mobile phone, it may only be possible to connect one device to the vehicle. Unpair the connected device from the vehicle and only pair and connect one device.

Is the mobile phone no longer responding?

- ▷ Switch the mobile phone off and back on again. Repeat the pairing procedure.

- ▷ Is the ambient temperature too high or too low? Do not subject your mobile phone to extreme ambient temperatures.

Telephone functions not possible.

- ▷ Is the mobile phone paired as an auxiliary phone and is the auxiliary phone function deactivated? Activate the function.
- ▷ Outgoing call not possible? Connect the mobile phone as a telephone.

Phone book entries are not displayed, not all of them are displayed, or they are displayed incompletely.

- ▷ The transfer of phone book entries has not yet completed.
- ▷ In some cases, only the phone book entries of the mobile phone or the SIM card will be transferred.
- ▷ It may not be possible to display phone book entries with special characters.
- ▷ The number of phone book entries to be stored is too high.
- ▷ The data volume of the phone book entry is too great, e.g. due to additionally stored information such as notes? Reduce the data volume.
- ▷ Is the mobile phone connected as an audio source or auxiliary phone? The mobile phone must be connected as a telephone.

The telephone connection quality is low.

- ▷ Depending on the mobile phone, it is possible to adjust the strength of the Bluetooth signal.
- ▷ Insert the mobile phone into the snap-in adapter or place it in the vicinity of the center console.
- ▷ Adjust the volume of the microphone and speaker separately.

If you have gone through all items in the list and still cannot activate the desired function, please check the website www.bmw.com/bluetooth for further notes or contact Customer Relations or a BMW center.

Operation

Adjusting volume

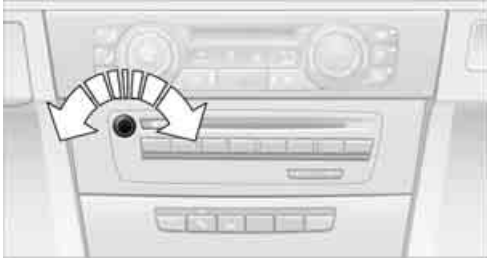

Turn the knob until the desired volume is reached. The setting is stored for the remote control currently in use.

The vehicle automatically adjusts the volume of the microphone on the mobile phone and the volume of the person on the phone with you. Depending on the mobile phone, it may be necessary to adjust the volumes.

Adjustments are only possible during a call and must be carried out separately for each phone. When the telephone is unpaired, this deletes the settings.

1. "Settings"
2. "Tone"
3. "Volume settings"
4. To select the desired setting: "Microphone" or "Loudspeak."
5. To adjust: turn the controller.
6. To store: press the controller.

Incoming call

Receiving calls

If the number of the caller is stored in the phone book and is transmitted by the network, then the name and number of the contact are displayed; otherwise, only the number is displayed.

If a contact is assigned more than one phone number, then only the name of the caller is displayed.

With calls to the auxiliary phone, only the number is displayed if it is transmitted by the network.

An incoming call to a phone is automatically rejected if a call on the other phone is currently active.

Accepting a call

Press the  button on the steering wheel or

 "Accept"

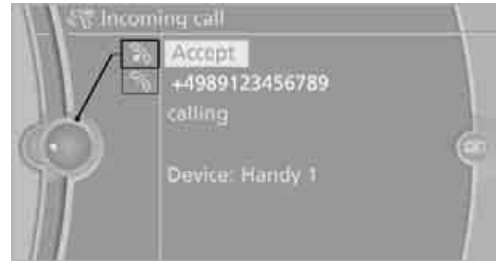



Rejecting a call

 "Reject"

The caller is connected to your mailbox if it has been activated.

Ending a call

Press the  button on the steering wheel or

1. "Telephone"
2.  "End call"



Entering phone numbers

Dialing a number

1. "Telephone"
2. "Dial number"
3. Select the digits individually.
4. Select the  symbol.



It is also possible to enter phone numbers by voice.

Calls with multiple parties

General information

It is possible to switch between two calls or to connect two calls to establish a conference call. These functions must be supported by the mobile phone and by the service provider.

Accepting a call while speaking to another party

This function may have to be activated by the service provider and the mobile phone may need to be set for this.

When a second call comes in during an ongoing call, a call-waiting signal sounds.

 "Accept"

The call is accepted and the existing call is put on hold.

Establishing a second call

Establish another call during an active call.

1. "Telephone"
2. "Active calls"
3.  "Hold"

The existing call is put on hold.

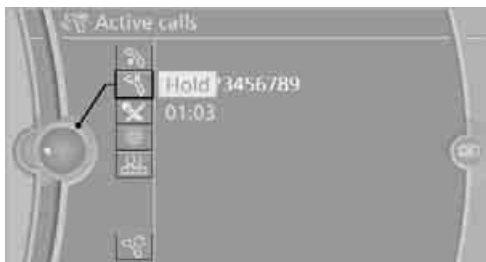

4. Dial the new phone number or select it from a list.

 "Return"

The call on hold is continued.

Switching between two calls, toggling

Active call: highlighted.

The call on hold is identified with "on hold...".

 "Swap calls"

The phone switches to the call on hold.



Establishing a conference call

Two calls can be connected to a single telephone conference call.

1. Establish two calls.
2.  "Conference call"

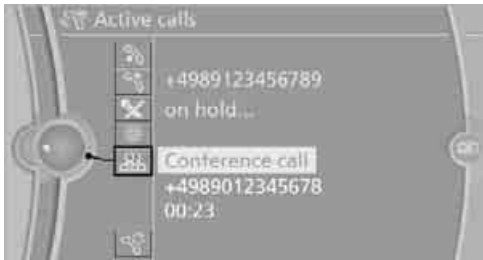

When terminating a conference call, both calls are ended. If one call is terminated by another party, the other call can be continued.

Muting the microphone

The microphone can be muted in active calls.

1. "Telephone"
2. "Active calls"
3.  "Microphone mute"

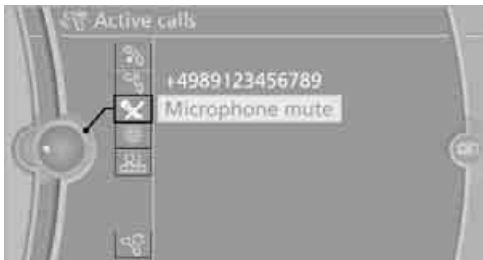

The muted microphone is automatically activated:

- ▷ If a new call is made.
- ▷ When switching between callers on hold.

Keypad dialing

Use keypad dialing to gain access to network services or to control devices, e.g. to remotely access an answering machine. This requires the DTMF code.

1. "Telephone"
2. Select contact from a list or "Dial number"

3.  "Keypad dialing"
4. Enter a DTMF code.

Phone book

Displays



The phone book accesses the contacts of the telephone and shows all contacts for which a phone number is entered. The entries can be selected to make a call.

1. "Telephone"
2. "Phone book"

A symbol indicates the storage location of the contacts, refer to page 214.



Calling a contact

Symbol	Meaning
	Contact with a stored phone number.
	Contact with more than one stored phone number.
	Call not possible. The mobile phone has no reception or network or a Service Request is currently active.

Contacts with a stored phone number: select the desired contact. The connection is established.

Contacts with more than one stored phone number: select the desired contact and then select the phone number. The connection is established.

Editing a contact

Changing entries in the "Contacts" menu. If a contact is changed, the changes are not stored in the mobile phone. A copy of the entry is stored in the vehicle.

1. Highlight the contact.
2. Open "Options".
3. "Edit entry"

The contact can be edited.

Redialing

General information

The list of dialed numbers in the mobile phone are transferred to the vehicle, depending on the mobile phone. In some cases, only numbers that were dialed from the vehicle are displayed.

The last 20 phone numbers dialed are displayed. The sorting of the phone numbers depends on the mobile phone.

Dialing the number via iDrive

1. "Telephone"
2. "Redial"

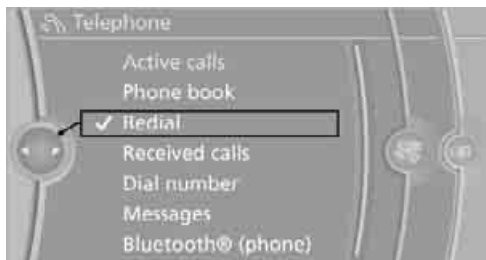

3. Select the desired entry and phone number, if necessary.

The connection is established.

Deleting a single entry or all entries

Deleting entries depends upon the mobile phone.

1. Highlight the entry.
2. Open "Options".
3. "Delete entry" or "Delete list".

Saving an entry in the contacts

1. Highlight the entry.
2. Open "Options".
3. "Store as new contact" or "Add to existing contact".
4. Select contact if necessary.
5. Select the type of number: "Home", "Business", "Mobile" or "Other".
6. Complete the entries if necessary.
7. "Store contact"

Received calls

Displaying calls

The list of received calls in the mobile phone is transferred into the vehicle, depending on the mobile phone. In some cases, only calls that were received in the vehicle are displayed.

The last 20 calls received are displayed. The sorting and displaying of phone numbers depends on the mobile phone.

1. "Telephone"
2. "Received calls"



Calling a number from the list

Select an entry.

The connection is established.

Deleting a single entry or all entries

Deleting entries depends upon the mobile phone.

1. Highlight the entry.
2. Open "Options".
3. "Delete entry" or "Delete list".

Saving an entry in the contacts

1. Highlight the entry.
2. Open "Options".
3. "Store as new contact" or "Add to existing contact".
4. Select contact if necessary.
5. Select the type of number: "Home", "Business", "Mobile" or "Other".
6. Complete the entries if necessary.
7. "Store contact"

Hands-free system

General information

Calls being conducted using the hands-free system can be continued using the mobile phone and vice versa.

From the mobile phone to the hands-free system

Calls that have been initiated from outside the Bluetooth range of the vehicle can be continued using the hands-free system if the ignition is switched on.

Depending on the mobile phone, the call is automatically switched to hands-free mode.

If the switch does not occur automatically, then follow the instructions that appear on the display of the mobile phone, also refer to the Owner's Manual for the mobile phone.

From hands-free system to mobile phone

Calls being conducted using the hands-free system can also be continued using the mobile phone if so desired, depending on the mobile phone.

At this point, follow the instructions that appear on the display of the mobile phone, also refer to the Owner's Manual for the mobile phone.

Operation by voice

With voice activation system:
Operation, refer to page 27.

Without voice activation system:
Depending upon the equipment, the mobile phone can be voice-operated as described below.

The list of short commands in the Owner's Manual does not apply to this type of voice operation.

The concept

- ▷ The mobile phone can be operated without removing your hand from the steering wheel.
- ▷ In many cases, the entry process is supported by means of announcements or questions.
- ▷ ›...‹ Verbal instructions to use with the voice operation system.

Voice commands

Activating voice activation system

1. Press the  button on the steering wheel.
2. Say the command.

Finishing voice input

Press the  button on the steering wheel or

 ›Cancel‹.

Possible commands

Having possible commands read aloud

The system understands default commands that must be spoken word for word.

 ›Help‹.

Possible commands are read aloud.

Digits from zero to nine are recognized.

Each digit can be spoken individually or combined into a sequence to accelerate the entry process.

Using alternative commands

There are often a number of commands to run a function, e.g.:

 ›Dial name⟨ or ›Name⟨.

Example: dialing phone numbers

1. Press the  button on the steering wheel.

2. ›Dial number⟨

The system replies: ››Please say the number⟨⟨.

3. For example: ›123 456 7890⟨

The system replies: ››123 456 7890. Continue?⟨⟨.

4. ›Dial⟨

The system replies: ››Dialing number⟨⟨.

Calling

Dialing phone numbers

 1. ›Dial number⟨.

2. Say the phone number.

3. ›Dial⟨.

The connection to the desired subscriber is established.

Correcting phone number

Digit sequences can be deleted after the system has repeated the digits.

 ›Correct number⟨.

The command can be repeated as often as necessary.

Deleting phone number

 ›Delete⟨.

All digits entered up to this point are deleted.

Redialing

 ›Redial⟨.

Voice phone book

Depending on how your vehicle is equipped, it may be necessary to create your own voice phone book.

The entries must be entered using voice commands and are separate from the memory in the mobile phone. Up to 50 entries can be set up.

Storing the entry

 1. ›Save name⟨.

2. Say the name aloud. Do not exceed a speaking duration of about 2 seconds.

3. Say the phone number after being prompted to do so by the system.

4. ›Save⟨.

Deleting the entry

 1. ›Delete name⟨.

2. Say the name when prompted.

3. Confirm request: ›Yes⟨

Deleting all entries

 1. ›Delete phonebook⟨.

The dialog for deleting phone book is opened.

2. Confirm request: ›Yes⟨

3. Confirm request again: ›Yes⟨

Reading and selecting the entries

 1. ›Read phonebook⟨.

The dialog for reading phone book is opened.

2. Say ›Dial number⟨ when the desired entry is read.

Selecting an entry

1. ›Dial name‹.
2. Say the name when prompted.
3. Confirm request: ›Yes‹

Adjusting volume

Turn knob during announcement.

- ▷ The volume remains the same, even if the volume of other audio sources is changed.
- ▷ The volume is stored for the remote control currently in use.

Notes

Notes on Emergency Requests

Do not use the voice operation system to initiate an emergency call. In stressful situations, the voice and vocal pitch can change. This can unnecessarily delay the establishment of a telephone connection.

Instead, use the SOS button, refer to page 272, in the vicinity of the interior rearview mirror.

Ambient conditions

- ▷ Say the commands, numbers and letters smoothly and with normal volume, emphasis and speed.
- ▷ Always say the commands in the language of the system. The language of the voice operation of the mobile phone is preset and cannot be changed via the Control Display.
- ▷ Keep the doors, windows, glass roof, and convertible top closed to prevent interference from outside noise.
- ▷ Avoid ambient noise in the vehicle while speaking.

Snap-in adapter

General information

Detailed information on snap-in adapters that compatibly support mobile phone functions can be found at your BMW center.

Notes

At high temperatures, the charging function of the mobile phone may be limited and some functions may no longer be carried out.

When using the mobile phone via the vehicle, follow the operating instructions of the mobile phone.

Installation location

In the center armrest.

Inserting snap-in adapter

1. Press the button and remove the cover.

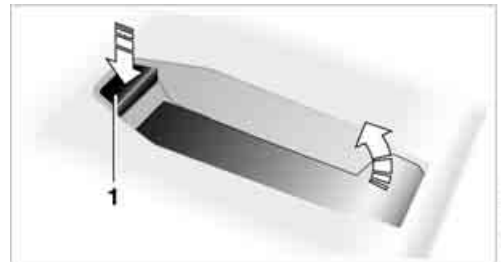

2. Insert the snap-in adapter at the front, arrow 1, and press downward, arrow 2, until it clicks into place.



Inserting mobile phone

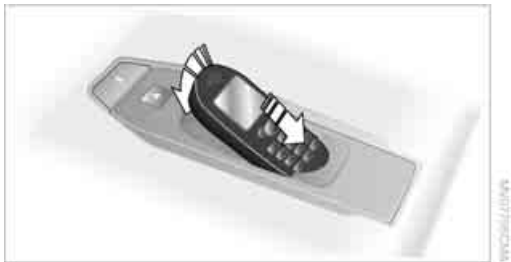

1. Depending on the mobile phone, it may be necessary to remove the protective cap of the antenna connector and from the USB connection of the mobile phone.
2. Push the mobile phone with the buttons facing upward toward the electrical connections and press down until it engages.

Removing mobile phone

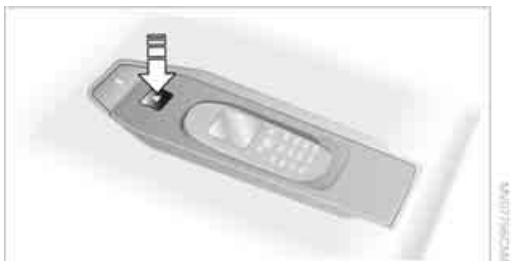

Press the button and remove the mobile phone.

Office

Vehicle equipment

In this chapter, all production, country, and optional equipment that is offered in the model range is described. Equipment is also described that is not available because of, for example, selected options or country version. This also applies to safety related functions and systems.

Overview

General information

Contacts, appointments, tasks, notes, text messages and mobile phone e-mails can be displayed using the Control Display if the mobile phone compatibly supports these functions and the required Bluetooth radio standards.

For information about which mobile phones and functions support the functions of Office, go to www.bmwusa.com/bluetooth.

A limited number of compatible mobile phones are available for Office.

Contents are only displayed completely when the vehicle is stopped.

Only read access to the mobile phone is possible.

 Do not use Office while driving. Make entries only when traffic and road conditions permit; otherwise, you may endanger vehicle occupants and other road users by being distracted. ◀

Requirements

- ▷ A suitable mobile phone is paired with the vehicle and connected. In some mobile phones, the data access to the mobile phone must be confirmed.

- ▷ Time zone, time, and date, refer to page 90, are correctly set on the Control Display and on the mobile phone in order, for example, to correctly display appointments.
- ▷ Office is activated, refer to page 201.

Updating

Every time that the mobile phone is connected to the vehicle, data are updated. Appointments, tasks, notes and reminders can be updated separately.

1. "Office"
 2. "Current office", "Calendar", "Tasks", "Notes" or "Reminders"
 3. Open "Options".
 4. "Update data"
- Data from the mobile phone are again transferred to the vehicle.

Current office

The number of unread messages and active tasks as well as upcoming appointments are displayed.

1. "Office"
2. "Current office"
3. Selecting the desired entry to display details.

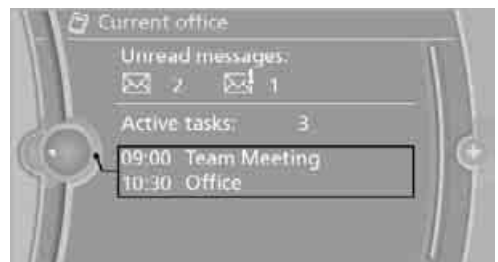

Contacts

General information

Contacts can be created and edited. The contacts from the mobile phone are displayed as well if this function is supported by the mobile phone. The addresses can be used as destinations for navigation and the phone numbers can be dialed.

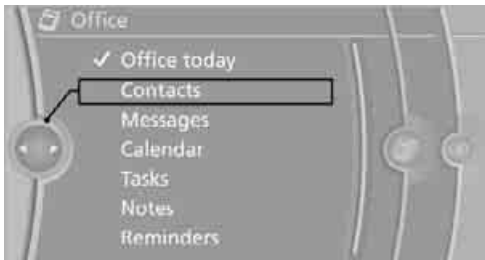

Displaying contacts

1. "Office"
2. "Contacts"



All contacts are listed in alphabetical order. Depending on the number of contacts, an A-Z search is offered.

A symbol indicates the storage location of the contacts:

Symbol	Storage location
No symbol	In the vehicle; the address has not been checked as a destination.
	In the vehicle; the address has been checked as a destination.
	Mobile phone

Dialing phone numbers

1. Select the desired contact.
2. Select phone number.
The connection is established.

Editing a contact

1. Select the desired contact.
2. "Edit contact"

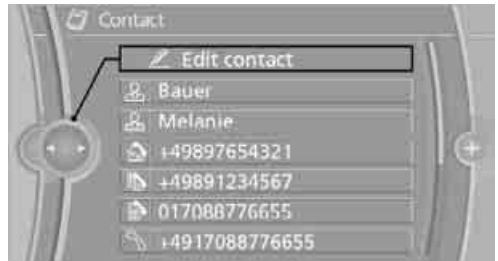

3. Change the entries.
4. "Store contact in vehicle"

If a contact is changed, the changes are not stored in the mobile phone. A copy of the entry is stored in the vehicle, and only this copy is displayed.

Selecting a contact as a destination

1. Select the desired contact.
2. Select address.
With contacts from the mobile phone, the address must be compared with the navigation data stored in the vehicle. In this case: Correct the address.
3. "Start guidance" or "Add as another destination"

Checking the address as a destination

An address that is to be used in route guidance must correspond to the navigation data stored in the vehicle. The address can be checked to ensure this.

1. Select the desired contact and highlight the address.
2. Open "Options".
3. "Check as destination"
4. Correct and store the address, if necessary.

If the address is corrected and stored, then a copy is established in the vehicle. The address is not changed on the mobile phone.

New contact

A contact can be associated with up to 8 phone numbers, 2 addresses, 3 email addresses, and one Internet address.







1. "Office"
2. "Contacts"
3. Open "Options".
4. "New contact"



5. If input boxes are already filled with previous entries: "Delete input fields".
6. To fill in the entry fields: select the symbol next to the entry field.
7. Enter text and assign a contact type.
8. When equipped with a navigation system: enter address. It is only possible to enter addresses that are contained in the navigation data stored in the vehicle. This ensures that route guidance is possible for all addresses.
9. "Accept address" if necessary
10. "Store contact in vehicle"

Contact types

Phone numbers and addresses can be assigned various contact types.

Symbol	Meaning
	Private phone number
	Business phone number
	Mobile phone number
	Other phone number
	Private address
	Business address

Defining a home address

It is possible to store a home address. It is listed at the beginning of the contacts.

1. "Home"
2. Create a contact.
3. "Store contact in vehicle"

Selecting name sorting

Names can be displayed in different orders.

1. "Office"
2. "Contacts"
3. Open "Options".
4. "Display: last, first name" or "Display: first, last name"

Depending on how the contacts are stored in your mobile phone, the sorting of names can differ from the sorting selected.

Displaying contact pictures

Pictures stored with contacts are stored in the vehicle when the mobile phone is connected to the vehicle. The mobile phone must support this function.

1. "Office"
2. "Contacts"
3. Open "Options".

4. "Configure Bluetooth@"
5. "Show images"

The display of all contact pictures is activated or deactivated.

Deleting contacts

Only contacts that are stored in the vehicle are deleted. The contacts on the mobile phone cannot be deleted.

1. "Office"
2. "Contacts"
3. Highlight the contact.
4. "Options"
5. "Delete contact" or "Delete all contacts".

Messages

General information

The displaying of text messages and emails from the mobile phone depends on whether the mobile phone supports transmission into the vehicle from the mobile phone. Text messages and e-mails may not be supported by the service provider or the function may have to be separately activated. After a mobile phone is paired for the first time, the transmission may take several minutes. Messages are only displayed completely when the vehicle is stopped. Messages from the auxiliary phone are not transmitted.

To display various messages:

- ▷ Text messages.
- ▷ Messages from My info.
- ▷ Messages from the BMW Concierge service.
- ▷ Messages from BMW Info.
- ▷ Emails from the mobile phone.

Displaying messages

1. "Office"
2. "Messages"

Message type

A symbol indicates the type of message.

- ✉ Read message.
- ✉ Unread message.

Symbol	Message type
✉	Text message
✉	My Info
✉	Message from the Concierge service, refer to page 225
✉	Messages from BMW Info, refer to page 218
✉@	E-mail from mobile phone

Filtering message lists

A message list can be filtered if there is more than one message type.

1. "Filter:"



2. Select the message type.
 - ▷ "All"
All messages are displayed.
 - ▷ "E-mail"
Only text messages from mobile phones are displayed.
 - ▷ "Services messages"
Only messages from the BMW Concierge service, My Info, and BMW Info are displayed.
 - ▷ "Text message"
Only text messages from mobile phones are displayed.

Deleting messages

Messages from the Concierge service, My Info, BMW Info, and BMW Online can be deleted.

To delete a message:

1. "Office"
2. "Messages"
3. Select the desired message.
4. Open "Options".
5. Open "Delete message".

To delete all messages:

1. "Office"
2. "Messages"
3. Open "Options".
4. "Delete all messages"

Text message

Calling a text message sender

1. Select the desired message.
2. Select the  symbol.

Saving sender in the contacts

1. Highlight the desired message.
2. Open "Options".
3. "Store as new contact" or "Add to existing contact"

Using contact data

Contact data from deadlines, tasks, text messages, e-mails and notes can be stored or selected, see page 220.



Reading text messages aloud

Having text messages read aloud, refer to page 221.

My Info

Selecting additional functions

Additional functions are available when a message is selected.

Symbol	Function
	"Start guidance" or "Add as another destination"
	"Call" If the message contains a number, a telephone connection is established.
	"Select phone number" If the message contains more than one number, select the desired number from the list. A telephone connection is established.



Messages from the Concierge service



Saving an address

1.  Select the desired message.
2. Open "Options".
3. "Store contact in vehicle"

Selecting additional functions

Additional functions are available when a message is selected.

Symbol	Function
	"Start guidance" or "Add as another destination"
	"Call" If the message contains a number, a telephone connection is established.

Symbol	Function
	"Select phone number" If the message contains more than one number, select the desired number from the list. A telephone connection is established.
	"Further information" Displaying additional information.

BMW Info

General information

Messages from BMW about technical campaigns and news from BMW.



Displaying messages





Select the desired message.

Selecting additional functions

The following functions are available when a message is selected:

Symbol	Function
	"Further information" Detailed information about a message is displayed. This does not incur any costs.
	"Start guidance" or "Add as another destination"

Symbol	Function
	"Call" If the message contains a number, a telephone connection is established.
	"Select phone number" If the message contains more than one number, select the desired number from the list. A telephone connection is established.

E-mail

Displaying e-mail

1. "Office"
2. "Messages"
3.  Select the desired message.

Displaying e-mail contacts

If the sender and receiver of an e-mail were transmitted from a mobile phone, they will be displayed in the e-mail.

 "Sender/Recipient"

If the e-mail address is stored in the contacts, then the contact is displayed. Select contact to display details.

If the e-mail address is not stored in the contacts, then it may be that only the e-mail address is displayed.

Using contact data

Contact data from deadlines, tasks, text messages, e-mails and notes can be stored or selected, see page 220.

Deactivating entire display

When opening an e-mail when in the vehicle, it is completely transferred to the vehicle. This may result in charges.

1. "Office"
2. "Messages"
3. Open "Options".

4. "Fully download e-mails"

Only a part of an e-mail from a mobile phone is loaded into the vehicle.

Reading e-mail

Reading e-mail, see page 221.

Calendar

Displaying calendar

Appointments from the last 20 days and the next 50 days can be displayed.

1. "Office"
2. "Calendar"

Appointments of the current day are displayed.



Selecting calendar day

1. Select date.



2. Select desired day or date.
 - ▷ "Next day"
 - ▷ "Date:"
 - ▷ "Previous day"
 - ▷ "Today"

Displaying appointment

1. Select the desired appointment.
2. To scroll through appointment, if necessary:
 - ▷ Turn the controller.
 - ▷ Select the   symbol.

Using contact data

Contact data from deadlines, tasks, text messages, e-mails and notes can be stored or selected, see page 220.

Reading an appointment aloud

Reading an appointment aloud, refer to page 221.

Tasks

Displaying task list

Display open tasks that must be completed within the next 90 days.

1. "Office"
2. "Tasks"

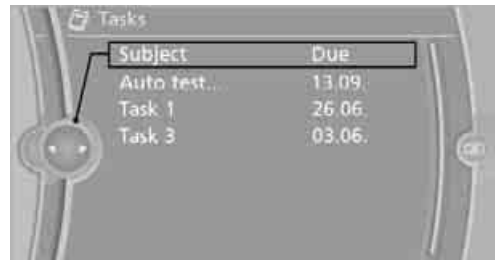

Sorting task list

1. Select the top line in the task list.



2. To select a sorting criterion:
 - ▷ "Priority (!)"
 - ▷ "Subject"
 - ▷ "Due date"

Displaying task

1. Select the desired task.
2. To scroll through the task, if necessary:
 - ▷ Turn the controller.
 - ▷ Select the   symbol.

Using contact data

Contact data from deadlines, tasks, text messages, e-mails and notes can be stored or selected, see page 220.

Reading a task aloud

Reading a task aloud, refer to page 221.

Notes

Displaying notes



1. "Office"
2. "Notes"

All notes are displayed.

Displaying a note

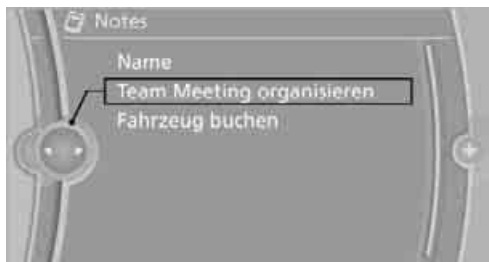
1. Select the desired note.



2. To scroll through the note, if necessary:
 - ▶ Turn the controller.
 - ▶ Select the   symbol.

Using contact data

Contact data from deadlines, tasks, text messages, e-mails and notes can be stored or selected, see page 220.

Reading a note aloud

Reading a note aloud, refer to page 221.

Reminders

Displaying reminders

Reminders for imminent appointments and tasks are displayed. After an appointment has passed or a task is due, the reminder is no longer displayed.

1. "Office"
2. "Reminders"
3. Select the desired reminder.

The associated appointment or task is displayed.

Using contact data

Overview

Contact data from deadlines, tasks, text messages, e-mails and notes can be stored or selected.

To display a contact or dial a phone number:

1.  "Use contact data"

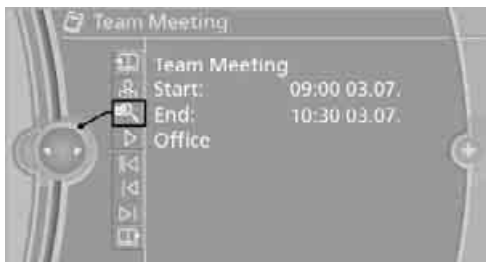

2. To display a contact or dial a phone number:
 - ▶ Select a contact to display a detailed view of the contact.
 - ▶ Select a phone number to directly establish a connection.

Storing contact data





1.  "Use contact data"
2. Highlight a phone number or e-mail address.
3. Open "Options".
4. "Add to existing contact" or "Store as new contact"

Reading aloud

Text messages, emails, appointments, tasks, and notes can be read aloud.

1. Select the desired message, appointment, task, or note.
2. Select the  symbol.

While the message is being read aloud, you have the following options:

- ▷  "Pause"
Interrupt the reading. Select again to resume the reading.
- ▷  "Back to beginning"
Read message again from the beginning.
- ▷  Select the symbol.
Skip back one paragraph.
- ▷  Select the symbol.
Skip over a paragraph.
- ▷ To terminate the reading, move the controller toward the left.

What to do if...

For information on suitable mobile phones, refer to page 200.

- ▷ Appointments, tasks, notes, texts, or emails from the mobile phone are not displayed?

The mobile phone is not suitable for the missing function or is not correctly connected.

The mobile phone has not been assigned the Office function.

The mobile phone is connected as an auxiliary phone.

The appointments are older than 20 days and are more than 50 days in the future.

The tasks have been marked as completed or are more than 90 days in the future.

Depending on the number of appointments, tasks, notes, and messages stored in the mobile phone, not all of them are displayed in the vehicle.

- ▷ Appointments or tasks from the mobile phone are not being displayed at the correct time?

The time zone, time, or date is incorrectly set in the Control Display and in the mobile phone.

- ▷ Texts of entries are not displayed completely?

Texts are already shortened by the mobile phone.

Synchronization between the mobile phone and vehicle can take a few minutes.

- ▷ Contact pictures are not being displayed?

Up to max. 200 contact pictures can be stored in the vehicle.

- ▷ If you have gone through all items in the list and still cannot activate the desired function please contact Customer Relations or a BMW center.

Contacts

Vehicle equipment

In this chapter, all production, country, and optional equipment that is offered in the model range is described. Equipment is also described that is not available because of, for example, selected options or country version. This also applies to safety related functions and systems.

Note

In equipment packages without mobile phone preparation.

General information

Contacts can be created and edited. The addresses can be used as destinations for navigation.

New contact

1. "Contacts"
2. "New contact"



3. If input boxes are already filled with previous entries: "Delete input fields".

4. To fill in the entry fields: select the symbol next to the entry field.



5. Entering text, refer to page 25.

When equipped with a navigation system: enter address. It is only possible to enter addresses that are contained in the navigation data stored in the vehicle. This ensures that route guidance is possible for all addresses.

6. "Store" if necessary
7. "Store contact in vehicle"

Defining a home address

It is possible to store a home address. It is listed at the beginning of the contacts.

1. "Home"
2. Create a contact.
3. "Store contact in vehicle"

My contacts

General information

List of all contacts that are stored in the vehicle.



Displaying contacts

1. "Contacts"
2. "My contacts"



All contacts are listed in alphabetical order. Depending on the number of contacts, an A-Z search is offered.

A symbol indicates the storage location of the contacts:

Symbol	Storage location
No symbol	In the vehicle; the address has not been checked as a destination.
	In the vehicle; the address has been checked as a destination.
	Mobile phone

Editing a contact

1. Select the desired contact.
2. "Edit contact"

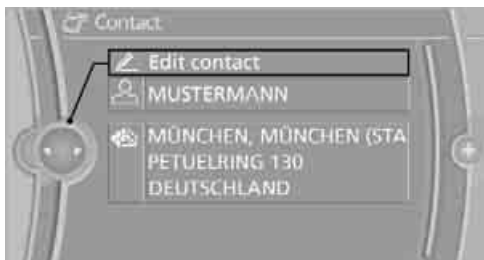

3. Change the entries.
4. Move the controller to the left.
5. "Yes"

Selecting a contact as a destination

1. Select the desired contact.
2. Select address.
3. "Start guidance" or "Add as another destination"

Checking the address as a destination

An address that is to be used in route guidance must correspond to the navigation data stored in the vehicle. The address can be checked to ensure this.

1. Select the desired contact and highlight the address.
2. Open "Options".
3. "Check as destination"
4. Correct and store the address, if necessary.

Selecting name sorting

Names can be displayed in different orders.

1. "My contacts"
2. Open "Options".
3. "Display: last, first name" or "Display: first, last name"

Exporting/importing contacts

Contacts can be exported and imported using Personal Profile, refer to page 32.

Deleting contacts

1. "My contacts"
2. Highlight the contact.
3. Open "Options".
4. "Delete contact" or "Delete all contacts".

ConnectedDrive

Vehicle equipment

In this chapter, all production, country, and optional equipment that is offered in the model range is described. Equipment is also described that is not available because of, for example, selected options or country version. This also applies to safety related functions and systems.

BMW Assist

General information

BMW Assist provides a number of different services. For example, the position data of the vehicle can be transmitted to the BMW Assist Response Center when an Emergency Request is sent.

Many BMW Assist services depend on the contract individually agreed upon.

After the contract has expired, the BMW Assist system will be deactivated by the BMW Assist Response Center without you having to visit a BMW center. After the BMW Assist system has been deactivated, no BMW Assist services will be available. The BMW Assist system can be reactivated by a BMW center after a new contract has been signed.

Requirements

- ▷ The installed BMW Assist system is logged into a mobile phone network. This network must be capable of transmitting the services.
- ▷ To transmit position data, the vehicle must be able to determine its current position.
- ▷ To activate and update BMW Assist, a GPS signal must be available.

- ▷ The BMW Assist service contract was signed with your BMW center or with the BMW Assist Response Center. The service must have been fully enabled.
- ▷ BMW Assist is activated.

Services offered

- ▷ **Emergency Request:** when you press the SOS button, a connection to the BMW Assist Response Center is established. The BMW Assist Response Center then speaks with you and takes further steps to help you.
- ▷ **Automatic Emergency Request:** under certain conditions, a connection to the BMW Assist Response Center is established after a serious accident. If possible, the BMW Assist Response Center then speaks with you and takes further steps to help you.
- ▷ **Enhanced Roadside Assistance:** BMW Roadside Assistance can be contacted if assistance is needed in the event of a breakdown. If possible, the vehicle data and position data are transmitted during this call.
- ▷ **Customer Relations:** connection to Customer Relations for information on all aspects of your vehicle.
- ▷ **BMW TeleService:** the data on your vehicle's service status or required inspections are transmitted to your BMW center, either automatically before a service due date or when you request a service appointment.
- ▷ **Remote Door Unlock:** the BMW Assist Response Center provides assistance if, for example, the remote control is not available and the vehicle needs to be opened.
- ▷ **Stolen Vehicle Recovery:** after you report to the police that your vehicle was stolen, the BMW Assist Response Center can determine its position.

- ▷ In addition, the optional Convenience Plan offers Concierge service and information on route planning, the traffic situation and weather. Using Critical Calling, a limited number of calls can be made via the BMW Assist Response Center, for example if the mobile phone is not available or discharged. Press the SOS button to contact the BMW Assist Response Center.

TeleService

General information

TeleService supports communication with your BMW center.

- ▷ Data on the vehicle's service requirements can be sent directly to the BMW center. In this way, the BMW center can plan its work in advance. This shortens the duration of the service appointment.
- ▷ In the event of a breakdown, data on the vehicle's condition can be sent directly to Roadside Assistance.
- ▷ The service varies by country.
- ▷ Connection may incur charges.
- ▷ Services may be restricted abroad.

Requirements

- ▷ BMW Assist is activated.
- ▷ Wireless reception is available.
- ▷ Ignition switched on.

Using TeleService

Generally, TeleService is activated in the vehicle.

If TeleService is not activated, it is possible to establish a voice contact to the BMW Group Mobile Service.

For additional uses or to deactivate the services, consult your BMW center or contact Customer Relations.

Concierge service

General information

The Concierge service of BMW Assist will inform you, for example, about upcoming events, filling station, or hotels and supplies you with their phone numbers and addresses. Many hotels can be booked directly through the BMW Assist Concierge service. Use of the Concierge service requires an additional activation by the BMW Assist Response Center.

Starting the Concierge service

1. "BMW Assist" or "ConnectedDrive"
2. "Concierge"



3. "Start service"

A voice contact with the BMW Concierge service is established. Phone numbers and addresses can be transmitted as a message.

Messages

Information about messages, refer to page 216.

Roadside Assistance

At a glance

BMW Roadside Assistance can be contacted if assistance is needed in the event of a breakdown.

Contact with BMW Roadside Assistance can also be established using a Check Control message, refer to page 92.

Starting BMW Roadside Assistance without BMW Assist or TeleService

1. "BMW Assist" or "ConnectedDrive"
2. "Roadside Assistance"

The Roadside Assistance number is displayed. If a mobile phone is paired, a connection to BMW Roadside Assistance is established.



Starting BMW Roadside Assistance with BMW Assist or TeleService

In a vehicle with TeleService, assistance is first offered through the TeleService Diagnosis and then if necessary, through the TeleService Help.

1. "BMW Assist" or "ConnectedDrive"
2. "Roadside Assistance"
3. "Start service"



BMW TeleService Diagnosis

Teleservice Diagnosis enables the wireless transmission of detailed vehicle data that are critical to vehicle diagnosis. These data are automatically transmitted.

After transmission of the data, a voice connection is established to Roadside Assistance.

BMW Online

Overview

You can use BMW Online to search the yellow pages.

License conditions:

This product contains NetFront Browser software of ACCESS Co., Ltd. Copyright © 2007 ACCESS Co., Ltd. All rights reserved.

NetFront is a trademark or registered trademark of ACCESS Co., Ltd., in Japan and other countries.

This software is based in part on the work of the Independent JPEG Group.

Requirements

- ▷ Subscription to the optional Convenience Plan.
- ▷ The vehicle is located within wireless network coverage.
- ▷ The date setting on the Control Display is current.

Starting BMW Online

1. "BMW Assist" or "ConnectedDrive"
2. "BMW Online"



3. "OK" if necessary

The BMW Online start page is displayed.

Using BMW Online

To select and display content:

- ▷ Turn the controller to highlight an element.
- ▷ Press the controller to display an element.

Opening the start page

1. Open "Options".
2. "Display start page"

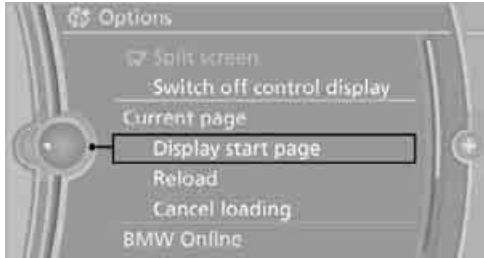

Loading a new page

1. Open "Options".
2. "Reload"

Canceling

1. Open "Options".
2. "Cancel loading"

Customer Relations

Overview

Contact Customer Relations for information on all aspects of your vehicle.

Calling Customer Relations

Vehicle not equipped with BMW Assist or TeleService

1. "BMW Assist" or "ConnectedDrive"
2. "Customer Relations"

The Customer Relations phone number is displayed. If a mobile phone is paired, a connection is established to Customer Relations.

Vehicle equipped with BMW Assist or TeleService

1. "BMW Assist" or "ConnectedDrive"
2. "Customer Relations"
3. "Start service"

Service Request

Overview

Inform your BMW center that you need to schedule a service appointment. The Teleservice data is transmitted during a Service Request. If possible, your BMW center will establish contact with you.

Starting a Service Request

1. "BMW Assist" or "ConnectedDrive"
2. "Service Request"
3. "Start service"

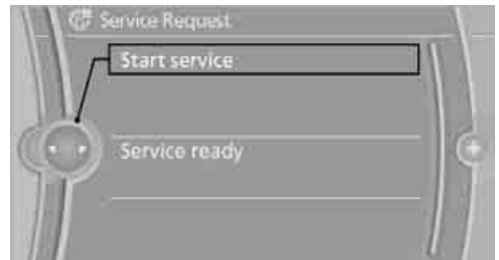

Automatic Service Request

The Teleservice data necessary for servicing the vehicle are automatically sent to your BMW center prior to the service deadline. If possible, the center will contact you and a service appointment can be arranged.

Check when your BMW center was notified.

1. "Vehicle Info"
2. "Vehicle status"



3. Open "Options".
4. "Last Service Request"

Service status

Displaying available services

Display of all services available in the vehicle.

1. "BMW Assist" or "ConnectedDrive"
2. "Service Status"
3. "Available services"

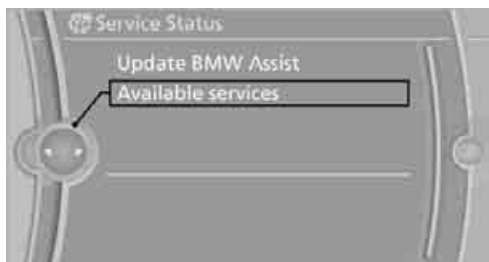

Updating BMW Assist

Manually updating BMW TeleService, BMW Assist, and BMW Online.

"Update BMW Assist"

Data transfer

The status of the data transfer is displayed.

1. "BMW Assist" or "ConnectedDrive"
2. Open "Options".
3. "Data transfer"

Apps

Overview

Certain software applications of a suitable mobile phone can be integrated into the vehicle. These software applications are displayed on the Control Display. They can be operated via iDrive.

Requirements

- ▷ The mobile phone's operating system supports the use of apps.
- ▷ Software applications are installed on the mobile phone and are operational.
- ▷ Suitable mobile phone.
- ▷ Appropriate mobile phone contract.

Additional costs possibly incurred are not included in the price of apps.

Information about suitable mobile phones, available software applications, and their installation can be found at www.bmw.com/connectivity or at your BMW center.

 Only make entries when traffic conditions permit. Otherwise, you may endanger vehicle occupants and other road users by being distracted.

For safety reasons, some software applications can only be used when the vehicle is stopped. ◀

 To avoid malfunctions, only use software applications approved by BMW. ◀

Using apps

1. Connect the mobile phone using the snap-in adapter or the USB audio interface.
2. "ConnectedDrive"
3. Select the desired software application.

Displaying status

You can display information about the currently available software applications.

1. "ConnectedDrive"
2. "BMW apps"

Plugin

Selected functions of the mobile phone are displayed on the Control Display. They can be operated via iDrive.

1. Connect the mobile phone using the snap-in adapter.
2. "ConnectedDrive"
3. "PlugIn"
4. "Activate PlugIn"
5. Use the controller to navigate in the displayed functions and select the desired category or track, for example.



Press the button to move one level up or back within the functions of the mobile phone.



Press the button twice to return back to the main menu.

Notes

- ▷ The range of apps that are displayed in the Control Display depends on the range of software applications installed on the mobile phone.
- ▷ The data transfer of the software applications from the mobile phone to the vehicle may take some time. Some software applications are dependent on the speed of the available Internet connection of the mobile phone.
- ▷ Certain versions of the mobile phone used and the software they use may not permit apps to be used at the same time as the Bluetooth hands-free system. If necessary, restart the software application on the mobile phone after completing a call.





Mobility

This section helps you maintain your car's mobility by supplying important information on vital topics including fuels and lubricants, wheels and tires, service, maintenance and Roadside Assistance.

Refueling

Vehicle equipment

In this chapter, all production, country, and optional equipment that is offered in the model range is described. For this reason, descriptions will be given of some equipment that may not be available in a vehicle, for example due to the special options or national-market version selected. This also applies to safety related functions and systems.

General information

 Refuel as soon as possible once your cruising range falls below 30 miles/ 50 km; otherwise, engine functions are not ensured and damage can occur. ◀

 Always switch off the engine before refueling; otherwise, fuel cannot be added to the tank and a message will be displayed. ◀

 Take all precautionary measures and observe all applicable regulations when handling fuel. Do not carry any spare fuel containers in your vehicle. They can develop a leak and cause an explosion or cause a fire in the event of an accident. ◀

Vehicles with diesel engines

The filler neck is designed for refueling at diesel fuel pumps.

Fuel filler flap

Opening

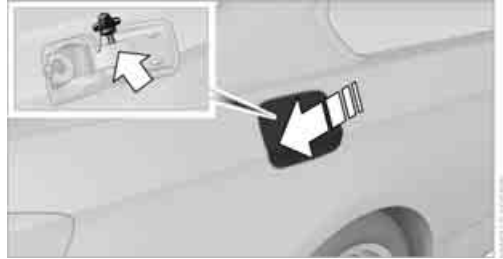

1. Open the fuel filler flap. To do so, lightly press the rear edge.
2. Turn the fuel cap counterclockwise.
3. Place the fuel cap in the bracket attached to the fuel filler flap.

Closing

Fit the cap and turn it clockwise until you clearly hear a click.

 Do not pinch the band attached to the cap; otherwise, the cap cannot be closed properly and fuel vapors can escape. A message will be displayed if the fuel cap is loose or missing. ◀

Manually releasing the fuel filler flap

In the event of a malfunction, you can release the fuel filler flap manually:

Coupe



1. Remove the cover from the right-hand sidewall of the trunk.
2. Pull the knob with the fuel pump symbol. The fuel filler flap is released.

Convertible

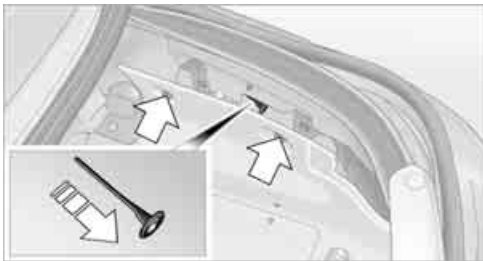

1. Loosen the right-hand trunk trim panel by turning the screws by 90°, see arrow.
2. Slightly lift the top section of the panel. It is not necessary to remove the entire panel.
3. Pull the knob with the fuel pump symbol. The fuel filler flap is released.

Observe the following when refueling

When refueling, insert the filler nozzle completely into the filler pipe. Avoid lifting the filler nozzle while filling the tank, as that would lead to

- ▷ Premature pump shutoff
- ▷ Reduced efficiency of the fuel-vapor recovery system.

The fuel tank is full when the filler nozzle clicks off the first time.

 Do not overfill the fuel tank; otherwise, fuel spills can cause damage to the environment and the vehicle. ◀

 When handling fuels, follow the safety instructions provided at filling stations; otherwise, there is a risk of personal injury or property damage. ◀

Fuel tank capacity

Approx. 16.1 US gal/61 liters, including the reserve capacity of 2.1 US gal/8 liters.

Fuel recommendations

Gasoline

For optimum fuel consumption, the gasoline should be sulfur-free or as low in sulfur as possible.

Never use fuels labeled at the fuel pump as metal-containing.

 Do not use leaded gasoline or gasoline with metal-containing additives such as manganese or iron; doing so can cause permanent damage to the catalytic converter or other components. ◀

Use fuels with a maximum ethanol content of 10 %, i.e. E10.

The ethanol should meet the following quality standards:

US: ASTM 4806-xx

CAN: CGSB-3.511-xx

xx: comply with the currently valid standard.

 Do not fill the tank with E85, i.e. fuel containing 85 % ethanol, nor with FlexFuel. Otherwise, the engine and fuel supply system will be damaged. ◀

The engine has a knock control function. It is therefore possible to use different fuel grades.

Fuel grade

BMW recommends AKI 91.

Minimum fuel grade

BMW recommends AKI 89.

 Do not use gasoline below the indicated minimum fuel grade; otherwise, proper engine function is not ensured. ◀

If you use gasoline with this minimum AKI rating, the engine may produce knocking sounds when starting at high outside temperatures.

This has no effect on the engine life.

 The use of poor-quality fuels may result in harmful engine deposits or damage.

Additionally, problems relating to drivability, starting and stalling may occur, especially under certain environmental conditions such as high ambient temperature and high altitude.

If drivability problems are encountered, we recommend switching to a high quality gasoline brand and a higher octane grade — AKI number — for a few tank fills. To avoid harmful engine deposits, we highly recommend purchasing gasoline from BP or Top Tier retailers.

Failure to comply with these recommendations may result in the need for unscheduled maintenance. ◀

BMW recommends BP fuels 

Wheels and tires

Vehicle equipment

In this chapter, all production, country, and optional equipment that is offered in the model range is described. For this reason, descriptions will be given of some equipment that may not be available in a vehicle, for example due to the special options or national-market version selected. This also applies to safety related functions and systems.

Tire inflation pressures

Information for your safety

It is not merely the tires' service life, but also driving comfort and, to a great extent, driving safety that depend on the condition of the tires and the maintenance of the specified tire pressure.

 Check the tire inflation pressure regularly and correct it, if necessary: at least twice a month and before starting long trips. If you fail to observe this precaution you may be driving on tires with incorrect tire pressures, a condition that can not only compromise your vehicle's driving stability, but also lead to tire damage and the risk of an accident. Do not drive with deflated, i.e. flat tires, except when using run-flat tires. A flat tire will seriously impair your vehicle's handling and braking response. Attempts to drive on a flat tire can lead to loss of control over the vehicle. ◀

Checking pressure

Only check tire inflation pressure when the tires are cold. This means after a maximum of 1.25 miles/2 km driving or when the vehicle has been parked for at least 2 hours. When tires are warm, the tire inflation pressure is higher.

 After correcting the tire inflation pressure, reset the Tire Pressure Monitor, refer to page 103, or reinitialize the Flat Tire Monitor, refer to page 100. ◀

Inflation pressure specifications

The tables below provide all the correct inflation pressures for the specified tire sizes at ambient temperature.

 The inflation pressures apply to the tire sizes approved and tire brands recommended by BMW; a list of these is available from your BMW center. ◀

For correct identification of the right tire inflation pressures, observe the following:

- ▷ Tire sizes for your vehicle
- ▷ Maximum allowable driving speed

Tire inflation pressures for driving up to 100 mph or 160 km/h

For normal driving up to 100 mph or 160 km/h and to achieve optimum driving comfort, adjust pressures to the respective tire inflation pressures listed on the following pages in the columns for traveling speeds up to a maximum of 100 mph or 160 km/h.

These tire inflation pressures can also be found on the driver's side door pillar when the driver's door is open.





 The maximum permissible speed for these tire pressures is 100 mph or 160 km/h. Do not exceed this speed; otherwise, tire damage and accidents could occur. ◀



Tire inflation pressures for driving above 100 mph or 160 km/h

 In order to drive at maximum speeds in excess of 100 mph or 160 km/h, adjust pressures to the respective tire inflation pressures listed on the following pages in the columns for traveling speeds including those exceeding 100 mph or 160 km/h. Otherwise, tire damage and accidents could occur. ◀



Observe all national and local maximum speed limits; otherwise, violations of the laws could occur.



Coupe: tire inflation pressures for the 328i

Tire size	Pressure specifications in bar/psi			
	Traveling speeds up to a max. of 100 mph/160 km/h		Traveling speeds including those exceeding 100 mph/160 km/h	
All pressure specifications in the table are indicated in bar/psi with cold tires. Cold = ambient temperature				
Without Sport Package:				
205/55 R 16 91 H M+S RSC				
225/50 R 16 92 H M+S RSC				
225/45 R 17 91 H M+S A/S RSC	2.2/32	2.6/38	2.5/36	3.0/44
225/45 R 17 91 H M+S RSC				
225/45 R 17 91 V RSC				
225/45 R 17 94 V M+S XL RSC	2.2/32	2.7/39	2.5/36	3.0/44
Front: 225/45 R 17 91 V RSC	2.2/32	-	2.5/36	-
Rear: 255/40 R 17 94 V RSC	-	2.4/35	-	2.7/39
Front: 225/40 R 18 88 W RSC	2.2/32	-	2.5/36	-
Rear: 255/35 R 18 90 W RSC	-	2.7/39	-	2.9/42
Front: 225/35 R 19 88 Y XL RSC	2.5/36	-	2.5/36	-
Rear: 255/30 R 19 91 Y XL RSC	-	3.0/44	-	3.0/44
Compact spare wheel: T 125/80 R 17 99 M	Traveling speeds up to a max. of 50 mph/80 km/h 4.2/60			
With Sport Package:				
205/55 R 16 91 H M+S RSC				
225/50 R 16 92 H M+S RSC	2.2/32	2.6/38	2.5/36	3.0/44
225/45 R 17 91 H M+S RSC				
225/45 R 17 91 V RSC	2.2/32	2.6/38	2.9/42	3.4/49
225/45 R 17 94 V M+S XL RSC	2.2/32	2.7/39	2.9/42	3.4/49
Front: 225/45 R 17 91 V RSC	2.2/32	-	2.9/42	-
Rear: 255/40 R 17 94 V RSC	-	2.4/35	-	3.0/44
Front: 225/40 R 18 88 W RSC	2.2/32	-	2.7/39	-
Rear: 255/35 R 18 90 W RSC	-	2.7/39	-	3.2/46



Tire size	Pressure specifications in bar/psi	
	Traveling speeds up to a max. of 100 mph/160 km/h	Traveling speeds including those exceeding 100 mph/160 km/h
All pressure specifications in the table are indicated in bar/psi with cold tires. Cold = ambient temperature		
	Front: 225/35 R 19 88 Y XL RSC Rear: 255/30 R 19 91 Y XL RSC	2.5/36 - - 3.0/44
Compact spare wheel: T 125/80 R 17 99 M	Traveling speeds up to a max. of 50 mph/80 km/h 4.2/60	



Coupe: tire inflation pressures for the 328xi

Tire size	Pressure specifications in bar/psi			
	Traveling speeds up to a max. of 100 mph/160 km/h		Traveling speeds including those exceeding 100 mph/160 km/h	
All pressure specifications in the table are indicated in bar/psi with cold tires. Cold = ambient temperature				
Without Sport Package:				
205/55 R 16 91 H M+S RSC				
225/50 R 16 92 H M+S RSC				
225/45 R 17 91 H M+S A/S RSC	2.2/32	2.6/38	2.4/35	2.9/42
225/45 R 17 91 H M+S RSC				
225/45 R 17 91 V RSC				
225/45 R 17 94 V M+S XL RSC	2.2/32	2.7/39	2.5/36	3.0/44
Front: 225/45 R 17 91 V RSC	2.2/32	-	2.3/33	-
Rear: 255/40 R 17 94 V RSC	-	2.3/33	-	2.7/39
Front: 225/40 R 18 88 W RSC	2.3/33	-	2.5/36	-
Rear: 255/35 R 18 90 W RSC	-	2.6/38	-	2.9/42
Front: 225/35 R 19 88 Y XL RSC	2.7/39	-	2.7/39	-
Rear: 255/30 R 19 91 Y XL RSC	-	3.0/44	-	3.0/44
Compact spare wheel: T 125/80 R 17 99 M	Traveling speeds up to a max. of 50 mph/80 km/h 4.2/60			

Tire size	Pressure specifications in bar/psi			
	Traveling speeds up to a max. of 100 mph/160 km/h		Traveling speeds including those exceeding 100 mph/160 km/h	
All pressure specifications in the table are indicated in bar/psi with cold tires. Cold = ambient temperature				
	With Sport Package:			
205/55 R 16 91 H M+S RSC				
225/50 R 16 92 H M+S RSC	2.2/32	2.6/38	2.4/35	2.9/42
225/45 R 17 91 H M+S RSC				
225/45 R 17 91 V RSC	2.2/32	2.6/38	2.8/41	3.3/48
225/45 R 17 94 V M+S XL RSC	2.2/32	2.7/39	2.8/41	3.3/48
Front: 225/45 R 17 91 V RSC	2.2/32	-	2.8/41	-
Rear: 255/40 R 17 94 V RSC	-	2.3/33	-	2.9/42
Front: 225/40 R 18 88 W RSC	2.3/33	-	2.7/39	-
Rear: 255/35 R 18 90 W RSC	-	2.6/38	-	3.2/46
Front: 225/35 R 19 88 Y XL RSC	2.7/39	-	2.8/41	-
Rear: 255/30 R 19 91 Y XL RSC	-	3.0/44	-	3.2/46
Compact spare wheel: T 125/80 R 17 99 M	Traveling speeds up to a max. of 50 mph/80 km/h 4.2/60			

Coupe: tire inflation pressures for the 335i

Tire size	Pressure specifications in bar/psi			
	Traveling speeds up to a max. of 100 mph/160 km/h		Traveling speeds including those exceeding 100 mph/160 km/h	
All pressure specifications in the table are indicated in bar/psi with cold tires. Cold = ambient temperature				
				
Without Sport Package:				
225/45 R 17 91 H M+S A/S RSC	2.2/32	2.7/39	2.6/38	3.1/45
225/45 R 17 91 H M+S RSC				
225/45 R 17 94 V M+S XL RSC	2.3/33	2.8/41	2.6/38	3.1/45
Front: 225/45 R 17 91 V RSC	2.2/32	-	2.6/38	-
Rear: 255/40 R 17 94 V RSC	-	2.4/35	-	2.8/41
Front: 225/40 R 18 88 W RSC	2.2/32	-	2.6/38	-
Rear: 255/35 R 18 90 W RSC	-	2.7/39	-	3.1/45
Front: 225/40 R 18 88 Y RSC	2.2/32	-	2.4/35	-
Rear: 255/35 R 18 90 Y RSC	-	2.7/39	-	2.8/41
Front: 225/35 R 19 88 Y XL RSC	2.6/38	-	2.6/38	-
Rear: 255/30 R 19 91 Y XL RSC	-	3.1/45	-	3.1/45
Compact spare wheel: T 125/80 R 17 99 M	Traveling speeds up to a max. of 50 mph/80 km/h 4.2/60			
With Sport Package:				
225/45 R 17 91 H M+S RSC	2.2/32	2.7/39	2.6/38	3.1/45
225/45 R 17 94 V M+S XL RSC	2.3/33	2.8/41	2.9/42	3.4/49
Front: 225/45 R 17 91 V RSC	2.2/32	-	2.6/38	-
Rear: 255/40 R 17 94 V RSC	-	2.4/35	-	3.0/44
Front: 225/40 R 18 88 W RSC	2.2/32	-	2.8/41	-
Rear: 255/35 R 18 90 W RSC	-	2.7/39	-	3.3/48
Front: 225/40 R 18 88 Y RSC	2.2/32	-	2.5/36	-
Rear: 255/35 R 18 90 Y RSC	-	2.7/39	-	3.0/44

Tire size	Pressure specifications in bar/psi			
	Traveling speeds up to a max. of 100 mph/160 km/h		Traveling speeds including those exceeding 100 mph/160 km/h	
All pressure specifications in the table are indicated in bar/psi with cold tires. Cold = ambient temperature				
	Front: 225/35 R 19 88 Y XL RSC	2.6/38	-	2.8/41
Rear: 255/30 R 19 91 Y XL RSC	-	3.1/45	-	3.3/48
Compact spare wheel: T 125/80 R 17 99 M	Traveling speeds up to a max. of 50 mph/80 km/h 4.2/60			

Coupe: tire inflation pressures for the 335xi

Tire size	Pressure specifications in bar/psi			
	Traveling speeds up to a max. of 100 mph/160 km/h		Traveling speeds including those exceeding 100 mph/160 km/h	

All pressure specifications in the table are indicated in bar/psi with cold tires.
Cold = ambient temperature





Without Sport Package:



225/45 R 17 91 H M+S A/S RSC	2.2/32	2.7/39	2.7/39	3.1/45
225/45 R 17 91 H M+S RSC				
225/45 R 17 94 V M+S XL RSC	2.3/33	2.8/41	2.7/39	3.1/45
Front: 225/45 R 17 91 V RSC	2.2/32	-	2.7/39	-
Rear: 255/40 R 17 94 V RSC	-	2.4/35	-	2.7/39
Front: 225/40 R 18 88 W RSC	2.4/35	-	2.6/38	-
Rear: 255/35 R 18 90 W RSC	-	2.7/39	-	2.9/42
Front: 225/40 R 18 88 Y RSC	2.4/35	-	2.4/35	-
Rear: 255/35 R 18 90 Y RSC	-	2.7/39	-	2.7/39
Front: 225/35 R 19 88 Y XL RSC	2.7/39	-	2.7/39	-
Rear: 255/30 R 19 91 Y XL RSC	-	3.1/45	-	3.1/45
Compact spare wheel: T 125/80 R 17 99 M	Traveling speeds up to a max. of 50 mph/80 km/h 4.2/60			

With Sport Package:



225/45 R 17 91 H M+S RSC	2.2/32	2.7/39	2.7/39	3.1/45
225/45 R 17 94 V M+S XL RSC	2.3/33	2.8/41	2.9/42	3.4/49
Front: 225/45 R 17 91 V RSC	2.2/32	-	2.7/39	-
Rear: 255/40 R 17 94 V RSC	-	2.4/35	-	3.0/44
Front: 225/40 R 18 88 W RSC	2.4/35	-	2.9/42	-
Rear: 255/35 R 18 90 W RSC	-	2.7/39	-	3.3/48
Front: 225/40 R 18 88 Y RSC	2.4/35	-	2.7/39	-
Rear: 255/35 R 18 90 Y RSC	-	2.7/39	-	2.9/42



Tire size	Pressure specifications in bar/psi	
	Traveling speeds up to a max. of 100 mph/160 km/h	Traveling speeds including those exceeding 100 mph/160 km/h
All pressure specifications in the table are indicated in bar/psi with cold tires. Cold = ambient temperature		
	Front: 225/35 R 19 88 Y XL RSC Rear: 255/30 R 19 91 Y XL RSC	2.7/39 - - 3.1/45
Compact spare wheel: T 125/80 R 17 99 M	Traveling speeds up to a max. of 50 mph/80 km/h 4.2/60	

Coupe: inflation pressures 335is



Tire size	Pressure specifications in bar/psi			
	Traveling speeds up to a max. of 100 mph/160 km/h		Traveling speeds including those exceeding 100 mph/160 km/h	
All pressure specifications in the table are indicated in bar/psi with cold tires. Cold = ambient temperature				
225/45 R 17 91 H M+S RSC	2.2/32	2.7/39	2.6/38	3.1/45
225/45 R 17 94 V M+S XL RSC	2.4/35	2.9/42	3.0/44	3.4/49
Front: 225/40 R 18 88 W RSC	2.3/33	-	2.9/42	-
Rear: 255/35 R 18 90 W RSC	-	2.8/41	-	3.4/49
Front: 225/40 R 18 88 Y RSC	2.3/33	-	2.6/38	-
Rear: 255/35 R 18 90 Y RSC	-	2.8/41	-	3.1/45
Front: 225/35 R 19 88 Y XL RSC	2.7/39	-	2.9/42	-
Rear: 255/30 R 19 91 Y XL RSC	-	3.2/46	-	3.4/49
Compact spare wheel: T 125/80 R 17 99 M	Traveling speeds up to a max. of 50 mph/80 km/h 4.2/60			

Convertible: tire inflation pressures for the 328i

Tire size	Pressure specifications in bar/psi			
	Traveling speeds up to a max. of 100 mph/160 km/h		Traveling speeds including those exceeding 100 mph/160 km/h	
All pressure specifications in the table are indicated in bar/psi with cold tires. Cold = ambient temperature				
				
Without Sport Package:				
205/55 R 16 91 H M+S RSC	2.3/33	2.8/41	2.5/36	3.0/44
225/50 R 16 92 H M+S RSC				
225/45 R 17 91 H M+S A/S RSC	2.3/33	2.8/41	2.7/39	3.2/46
225/45 R 17 91 H M+S RSC				
225/45 R 17 91 W RSC	2.3/33	2.8/41	2.5/36	3.0/44
225/45 R 17 94 V M+S XL RSC	2.4/35	2.9/42	2.7/39	3.2/46
Front: 225/45 R 17 91 V RSC	2.2/32	-	2.5/36	-
Rear: 255/40 R 17 94 V RSC	-	2.5/36	-	2.9/42
Front: 225/40 R 18 88 W RSC	2.4/35	-	2.6/38	-
Rear: 255/35 R 18 90 W RSC	-	2.9/42	-	3.1/45
Front: 225/40 R 18 88 Y RSC	2.4/35	-	2.4/35	-
Rear: 255/35 R 18 90 Y RSC	-	2.9/42	-	2.9/42
Front: 225/35 R 19 88 Y XL RSC	2.7/39	-	2.7/39	-
Rear: 255/30 R 19 91 Y XL RSC	-	3.2/46	-	3.2/46
Compact spare wheel: T 125/80 R 17 99 M	Traveling speeds up to a max. of 50 mph/80 km/h 4.2/60			

Tire size	Pressure specifications in bar/psi			
	Traveling speeds up to a max. of 100 mph/160 km/h		Traveling speeds including those exceeding 100 mph/160 km/h	
All pressure specifications in the table are indicated in bar/psi with cold tires. Cold = ambient temperature				
With Sport Package:				
205/55 R 16 91 H M+S RSC	2.3/33	2.8/41	2.5/36	3.0/44
225/50 R 16 92 H M+S RSC				
225/45 R 17 91 H M+S RSC	2.3/33	2.8/41	2.8/41	3.3/48
225/45 R 17 91 W RSC				
225/45 R 17 94 V M+S XL RSC	2.4/35	2.9/42	2.9/42	3.4/49
Front: 225/45 R 17 91 V RSC	2.2/32	-	2.8/41	-
Rear: 255/40 R 17 94 V RSC	-	2.5/36	-	3.1/45
Front: 225/40 R 18 88 W RSC	2.4/35	-	2.9/42	-
Rear: 255/35 R 18 90 W RSC	-	2.9/42	-	3.4/49
Front: 225/40 R 18 88 Y RSC	2.4/35	-	2.6/38	-
Rear: 255/35 R 18 90 Y RSC	-	2.9/42	-	3.1/45
Front: 225/35 R 19 88 Y XL RSC	2.7/39	-	2.9/42	-
Rear: 255/30 R 19 91 Y XL RSC	-	3.2/46	-	3.4/49
Compact spare wheel: T 125/80 R 17 99 M	Traveling speeds up to a max. of 50 mph/80 km/h 4.2/60			

Convertible: tire inflation pressures for the 335i



Tire size	Pressure specifications in bar/psi	
	Traveling speeds up to a max. of 100 mph/160 km/h	Traveling speeds including those exceeding 100 mph/160 km/h
All pressure specifications in the table are indicated in bar/psi with cold tires. Cold = ambient temperature		

Without Sport Package:



225/45 R 17 91 H M+S A/S RSC	2.3/33	2.8/41	2.7/39	3.2/46
225/45 R 17 91 H M+S RSC				
225/45 R 17 94 V M+S XL RSC	2.4/35	2.9/42	2.7/39	3.2/46
Front: 225/45 R 17 91 V RSC	2.2/32	-	2.5/36	-
Rear: 255/40 R 17 94 V RSC	-	2.5/36	-	2.9/42
Front: 225/40 R 18 88 W RSC	2.4/35	-	2.6/38	-
Rear: 255/35 R 18 90 W RSC	-	2.9/42	-	3.1/45
Front: 225/40 R 18 88 Y RSC	2.4/35	-	2.4/35	-
Rear: 255/35 R 18 90 Y RSC	-	2.9/42	-	2.9/42
Front: 225/35 R 19 88 Y XL RSC	2.7/39	-	2.7/39	-
Rear: 255/30 R 19 91 Y XL RSC	-	3.2/46	-	3.2/46
Compact spare wheel: T 125/80 R 17 99 M	Traveling speeds up to a max. of 50 mph/80 km/h 4.2/60			

With Sport Package:

225/45 R 17 91 H M+S RSC	2.3/33	2.8/41	2.7/39	3.2/46
225/45 R 17 94 V M+S XL RSC	2.4/35	2.9/42	2.9/42	3.4/49
Front: 225/45 R 17 91 V RSC	2.2/32	-	2.8/41	-
Rear: 255/40 R 17 94 V RSC	-	2.5/36	-	3.1/45
Front: 225/40 R 18 88 W RSC	2.4/35	-	2.9/42	-
Rear: 255/35 R 18 90 W RSC	-	2.9/42	-	3.4/49
Front: 225/40 R 18 88 Y RSC	2.4/35	-	2.6/38	-
Rear: 255/35 R 18 90 Y RSC	-	2.9/42	-	3.1/45

Tire size	Pressure specifications in bar/psi			
	Traveling speeds up to a max. of 100 mph/160 km/h		Traveling speeds including those exceeding 100 mph/160 km/h	
All pressure specifications in the table are indicated in bar/psi with cold tires. Cold = ambient temperature				
			max.	
Front: 225/35 R 19 88 Y XL RSC	2.7/39	-	2.9/42	-
Rear: 255/30 R 19 91 Y XL RSC	-	3.2/46	-	3.4/49
Compact spare wheel: T 125/80 R 17 99 M	Traveling speeds up to a max. of 50 mph/80 km/h 4.2/60			

Convertible: inflation pressures 335is

Tire size	Pressure specifications in bar/psi			
	Traveling speeds up to a max. of 100 mph/160 km/h		Traveling speeds including those exceeding 100 mph/160 km/h	
All pressure specifications in the table are indicated in bar/psi with cold tires. Cold = ambient temperature				
			max.	
225/45 R 17 91 H M+S RSC	2.3/33	2.8/41	2.7/39	3.2/46
225/45 R 17 94 V M+S XL RSC	2.4/35	2.9/42	2.9/42	3.4/49
Front: 225/40 R 18 88 W RSC	2.4/35	-	2.9/42	-
Rear: 255/35 R 18 90 W RSC	-	2.9/42	-	3.4/49
Front: 225/40 R 18 88 Y RSC	2.4/35	-	2.6/38	-
Rear: 255/35 R 18 90 Y RSC	-	2.9/42	-	3.1/45
Front: 225/35 R 19 88 Y XL RSC	2.7/39	-	2.9/42	-
Rear: 255/30 R 19 91 Y XL RSC	-	3.2/46	-	3.4/49
Compact spare wheel: T 125/80 R 17 99 M	Traveling speeds up to a max. of 50 mph/80 km/h 4.2/60			

Tire identification marks

Knowledge of the labeling on the side of the tire makes it easier to identify and choose the right tires.

Tire size

e.g. 225/45 R 17 91 V

Nominal width in mm

Aspect ratio in %

Radial belt construction

Rim diameter in inches

Load rating, not on ZR tires

Speed code letter, in front of the R on ZR tires

Speed code letter

Q = up to 100 mph or 160 km/h

T = up to 118 mph or 190 km/h

H = up to 131 mph or 210 km/h

V = up to 150 mph or 240 km/h

W = up to 167 mph or 270 km/h

Y = up to 186 mph or 300 km/h

Tire Identification Number

Tires with DOT codes meet the guidelines of the US Department of Transportation.

DOT code:

e.g. DOT xxxx xxx 4012

Manufacturer's code for tire make

Tire size and tire design

Tire age

Tire age

The manufacturing date of tires is contained in the tire coding: DOT ... 1013 means that the tire was manufactured in week 10 of 2013.

BMW recommends that you replace all tires after 6 years at most, even if some tires may last for 10 years.

Uniform Tire Quality Grading

Quality grades can be found where applicable on the tire sidewall between tread shoulder and maximum section width. For example:

Tread wear 200 Traction AA

Temperature A

DOT Quality Grades

Tread wear

Traction AA A B C

Temperature A B C



All passenger car tires must conform to Federal Safety Requirements in addition to these grades. ◀

Tread wear

The tread wear grade is a comparative rating based on the wear rate of the tire when tested under controlled conditions on a specified government test course. For example, a tire graded 150 would wear one and one-half (1 ½) times as well on the government course as a tire graded 100. The relative performance of tires depends upon the actual conditions of their use, however, and may depart significantly from the norm due to variations in driving habits, service practices and differences in road characteristics and climate.

Traction

The traction grades, from highest to lowest, are AA, A, B, and C.

These grades represent the tire's ability to stop on wet pavement, as measured under controlled conditions on specified government test surfaces of asphalt and concrete. A tire marked C may have poor traction performance.

! The traction grade assigned to this tire is based on straight-ahead braking traction tests, and does not include acceleration, cornering, hydroplaning, or peak traction characteristics. ◀

Temperature

The temperature grades are A, the highest, B, and C, representing the tire's resistance to the generation of heat and its ability to dissipate heat when tested under controlled conditions on a specified indoor laboratory test wheel. Sustained high temperature can cause the material of the tire to degenerate and reduce tire life, and excessive temperature can lead to sudden tire failure. The grade C corresponds to a level of performance which all passenger car tires must meet under the Federal Motor Vehicle Safety Standard No. 109. Grades B and A represent higher levels of performance on the laboratory test wheel than the minimum required by law.

! The temperature grade for this tire is established for a tire that is properly inflated and not overloaded. Excessive speed, underinflation, or excessive loading, either separately or in combination, can cause heat buildup and possible tire failure. ◀

RSC – run-flat tires

You will recognize run-flat tires by a circular symbol containing the letters RSC on the side of the tire, refer to page [252](#).

M+S

Winter and all-season tires. These have better winter properties than summer tires.

XL

Designation for specially reinforced tires.

Tire condition

Inspect your tires frequently for tread wear, signs of damage and for foreign objects lodged in the tread. Check the tread depth.

Minimum tread depth

The tread depth should not drop below 0.12 in/ 3 mm, although, for example, European legislation only specifies a minimum tread depth of 0.063 in/1.6 mm. At tread depths below 0.12 in/ 3 mm there is an increased risk of high-speed hydroplaning, even when only small amounts of water are present on the road surface. When winter tires wear down past a tread depth of 0.16 in/4 mm, they become perceptibly less suitable for winter conditions. In the interest of safety, new tires should be installed.

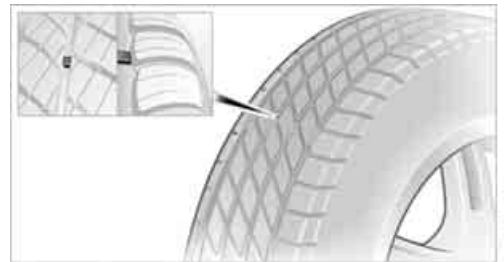

Wear indicators in the base of the tread groove are distributed around the tire's circumference; the letters TWI, for Tread Wear Indicator, on the tire's sidewalls identify tires that incorporate these wear indicators. Once the tire tread has worn down to the wear indicators, the tire has worn to a depth of 0.063 in/1.6 mm.

Wheel/tire damage

Driving over rough or damaged road surfaces, as well as debris, curbs and other obstacles can cause serious damage to wheels, tires, and suspension parts. This is more likely to occur with low-profile tires, which provide less cushioning between the wheel and the road. Be careful to avoid road hazards and reduce your speed, especially if your vehicle is equipped with low-profile tires.

Unusual vibrations encountered during normal vehicle operation can indicate tire failure or some other vehicle defect. This can, for example, be caused by driving over curbs. The same applies to any other abnormal road behavior, such as pulling severely to the right or left.

 In these cases, reduce speed immediately and have wheels and tires thoroughly checked. To do so, drive carefully to the nearest BMW center or tire dealer. If necessary, have the vehicle towed there. Otherwise, tire damage can pose a lethal hazard to vehicle occupants and other road users. ◀

Tire age

For various reasons, such as the development of brittleness, BMW recommends tire replacement after no more than 6 years, regardless of the actual wear of the tires.

The manufacturing date of tires is contained in the tire coding:
DOT ... 1013 means that the tire was manufactured in week 10 of 2013.

New wheels and tires

 Have new wheels and tires mounted only by your BMW center or by a tire dealer. If this work is not carried out properly, there is a danger of subsequent damage and related safety hazards. Make sure that the new wheels are balanced. ◀

Retreaded tires

 BMW recommends that you do not use retreaded tires, since driving safety may be impaired. The causes for this include potentially different tire casing structures and often wide variations in tire age, which can result in a limited service life. ◀

Correct wheels and tires

When mounting new tires or changing over from summer to winter tires and vice versa, mount run-flat tires for your own safety. In the event of a flat, no spare wheel is available. Your BMW center will be glad to advise you.

 BMW recommends that you use only wheel and tire combinations that BMW has tested and approved for your particular vehicle. Variations in factors such as manufacturing tolerances mean that even wheels and tires with identical official size ratings could actually have different dimensions, which could lead to body contact and thus to severe accidents. If non-approved wheels and tires are used, BMW cannot evaluate their suitability, and therefore cannot guarantee their driving safety. ◀

You can inquire about the right wheel/tire combination at your BMW center.

The correct combination of wheels and tires is also necessary to ensure reliable operation of various vehicle systems such as ABS, DSC or FTM.

To maintain good handling and vehicle response, use only tires of a single brand and tread configuration. After a tire has been damaged, mount the previous wheel and tire combination again as soon as possible.

Wheels with Tire Pressure Monitor TPM electronics

When mounting new tires or changing over from summer to winter tires, or vice versa, only use wheels with TPM electronics; otherwise, the Tire Pressure Monitor may not be able to detect a puncture, refer to page 102. Your BMW center will be glad to advise you.

Recommended tire brands

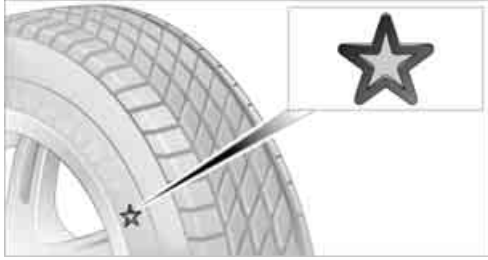

Certain makes of tire are recommended by BMW for each tire size. They are marked with a clearly visible BMW designation on the sidewall of the tire.

When properly used, these tires meet the highest standards in terms of safety and handling characteristics.

Special characteristics of winter tires

BMW recommends winter tires for driving on winter roads or at temperatures below +45 °F / +7 °C. Although all-season M+S tires provide better winter traction than summer tires, they generally fail to provide the same levels of cold-weather performance as winter tires.

Pay attention to speed

! Always comply with the speed limit for the winter tires mounted on your car; failure to do so could result in tire damage and accidents. ◀

If the car is capable of speeds higher than that permitted for the winter tires, a label stating the maximum permitted speed for the mounted tires must be displayed in your field of view. Specialist tire dealers and your BMW center can supply these labels.

Storage

Always store wheels and tires in a cool, dry place with as little exposure to light as possible. Always protect tires against all contact with oil, grease and fuels. Do not exceed the maximum tire inflation pressure indicated on the sidewall of the tire.

Swapping wheels between axles

BMW advises against swapping wheels between the front and rear axles, even if all tires have the same size, as this could impair driving characteristics. If the tires are of mixed sizes, swapping wheels between the axles is not permissible.

Run-flat tires



The symbol identifying run-flat tires is a circle with the letters RSC on the sidewall. Run-flat tires comprise a conditionally self-supporting tire and a special rim. The reinforcement in the sidewalls ensures that the tire can continue to be used subject to certain restrictions, even if depressurized.

For information on continuing to drive with a flat tire, refer to Indication of a flat tire, page 101.

Snow chains

Only certain fine-link snow chains have been tested by BMW, classified as safe for use and recommended. Consult your BMW center for more information.

Snow chains must be mounted in pairs and on the rear wheels only. Observe the manufacturer's instructions when mounting snow chains. Do not exceed a speed of 30 mph or 50 km/h.



Do not initialize the Flat Tire Monitor if snow chains are mounted; otherwise, the instrument might issue an incorrect reading. When driving with snow chains, you may find it helpful to activate DTC temporarily, refer to page 98. ◀

Engine compartment

Vehicle equipment

In this chapter, all production, country, and optional equipment that is offered in the model range is described. For this reason, descrip-

tions will be given of some equipment that may not be available in a vehicle, for example due to the special options or national-market version selected. This also applies to safety related functions and systems.

Important parts of the engine compartment



- 1 Expansion tank for coolant, refer to page [259](#)
- 2 Washer fluid filler neck for headlamp cleaning system and window washer system, refer to page [74](#)
- 3 Jump-starting connection, refer to page [274](#)
- 4 Filler neck for engine oil, refer to Adding engine oil

Hood

 Do not work on the car unless you possess the necessary technical knowledge. If you are not familiar with the regulations to be followed, have the necessary work on the vehi-

cle carried out only by your BMW center; if this work is not carried out properly, there is a danger of subsequent damage and related safety hazards. ◀

Releasing

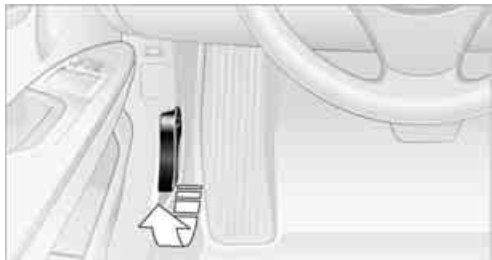

Pull the lever.

Opening



! In order to avoid damage, make sure that the wiper arms are against the windshield before you open the hood. Do not open the engine hood before the engine has cooled down; otherwise, injuries may result. ◀

Press the release handle and open the hood.

Closing



Let the hood drop from a height of approx. 10 in/ 25 cm. It must be clearly heard to engage.

! Make sure that the closing path of the hood is clear; otherwise, injuries may result.

If you see any signs while driving your vehicle that the hood is not completely closed, stop at once and close it securely. ◀

Engine oil

General information

The engine oil consumption is dependent on driving style and operating conditions; for example, the engine oil consumption is significantly higher with a very sporty driving style. For this reason, regularly check the oil level after each time you refuel.

Checking oil level

Your car is equipped with an electronic oil-level monitor.

For a precise measurement and display of the oil level, it is necessary that the engine be at operating temperature, i.e. after uninterrupted driving for at least approx. 6.2 miles/10 km. You can have the oil level displayed while you are driving, or while the vehicle is at a standstill on a level surface and the engine is running.

Display in the instrument cluster



1. Push button **1** in the turn signal/high beam lever up or down repeatedly until the appropriate symbol is shown in the display, accompanied by the word "OIL".
2. Press button **2** in the turn signal/high beam lever.

The oil level is checked and the reading displayed.

Possible displays



- 1 Oil level OK
- 2 Oil level is being checked.
This can take about 3 minutes if the car is at a standstill on a level surface, or about 5 minutes while the car is on the move.
- 3 Oil level down to minimum:
Add engine oil as soon as possible, but no more than 1 US quart/1 liter, refer also to Adding engine oil on page 258.
- 4 Oil level is too high.
 Too much oil will harm the engine. Have the vehicle checked without delay. ◀
- 5 The oil level sensor is defective.
Do not add engine oil. You can continue your journey. Note the newly calculated distance remaining to the next oil service, refer to page 88. Have the system checked as soon as possible.

Display via iDrive

1. "Vehicle Info"
2. "Vehicle status"



3. "Engine oil level"



Possible messages

- ▷ "Engine oil level OK"
- ▷ "Measurement not possible at this time."
- ▷ "Measuring engine oil level...":
This can take about 3 minutes if the car is at a standstill on a level surface and the engine is running, and about 5 minutes while the car is moving.
If engine oil was added, it may take up to 30 minutes to obtain an oil level reading.
- ▷ "Engine oil level below minimum. Add 1 quart!"
Add engine oil as soon as possible, but no more than 1 US quart/1 liter, refer also to Adding engine oil below.
If the oil level is below the minimum value, add engine oil immediately to avoid engine damage.

- ▷ "Engine oil level too high! Have this checked."
 -  Too much oil will harm the engine. Have the vehicle checked without delay. ◀
- ▷ "Measurement inactive. Have this checked."
 - Do not add engine oil. You can continue your journey. Note the newly calculated distance remaining to the next oil service, refer to page 88. Have the system checked as soon as possible.

Adding engine oil

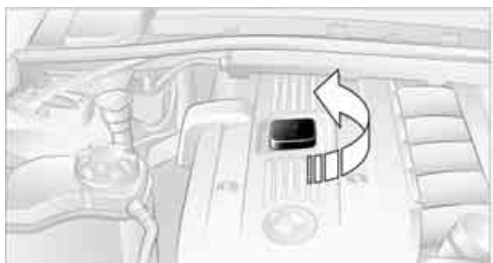

Add up to 1 US quart/1 liter of engine oil only after a corresponding message is shown on the Control Display.

 Add oil within the next 125 miles/200 km; otherwise, the engine could be damaged. ◀

 If the engine oil is too high, have the vehicle checked immediately; failure to do so may result in engine damage. ◀

 Keep oils, greases, etc. out of the reach of children and comply with the relevant warnings on the containers. Otherwise, health hazards may result. ◀

Oil grades to add

 Do not use oil additives as this could result in engine damage. ◀

 When selecting an engine oil, make sure to use one from the SAE viscosity classes 0W-40, 0W-30, 5W-40 or 5W-30; failure to do so may result in malfunctions or engine damage. ◀

The engine oil quality is critical for the life of the engine.

Some oil grades may not be available in all countries.

Approved oil grades

Gasoline engine

BMW High Performance SAE 5W-30

BMW Longlife-01

BMW Longlife-01 FE

Diesel engine

BMW Longlife-04

Additional information about approved oil grades is available at your BMW center.

Alternative oil types

If approved oils are not available, you can add quantities of up to 1 US quart/1 liter of another oil with the following specifications:

Gasoline engine

API SM or higher

Diesel engine

API ILSAC GF-5

Oil change

Oil changes should only be performed by a BMW center.

BMW recommends 

Coolant

Coolant consists of half water and half additive. Not all commercially available additives are suitable for your BMW. Ask your BMW center about suitable additives.

 Only use suitable additives; otherwise, engine damage may result. Because additives are harmful to your health, it is important to follow the instructions on the containers. ◀

 Comply with the appropriate environmental protection regulations when disposing of coolant additives. ◀

Coolant temperature

If the coolant and therefore the engine overheats, a warning lamp lights up. A message appears on the Control Display.

Checking coolant level

 Do not add coolant to the cooling system when the engine is hot. Escaping coolant can cause burns. ◀

1. Do not open the engine hood before the engine has cooled down.
2. Turn the cap of the expansion tank a little counterclockwise to allow any accumulated pressure to escape, then continue turning to open.



3. The level indicator **1** in the coolant filler neck indicates the level of coolant. The coolant level is correct when it is between the arrows of the respective inscription on the reservoir **2**.

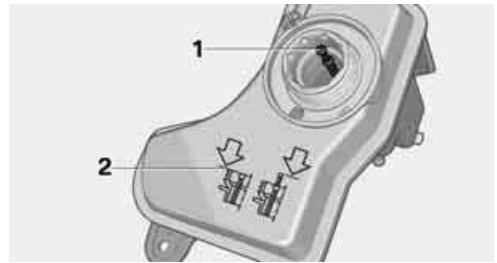

4. If the coolant is low, slowly add coolant up to the specified level; do not overfill.
5. Turn the cap until there is an audible click.
6. Have the reason for the coolant loss eliminated as soon as possible.

Maintenance

Vehicle equipment

In this chapter, all production, country, and optional equipment that is offered in the model range is described. For this reason, descriptions will be given of some equipment that may not be available in a vehicle, for example due to the special options or national-market version selected. This also applies to safety related functions and systems.

BMW Maintenance System



The BMW Maintenance System advises you of necessary maintenance measures and helps you maintain the traffic and operating safety of the vehicle.

Condition Based Service CBS

Sensors and special algorithms take the different driving conditions of your BMW into account. Condition Based Service uses this to determine the current and future service requirements. By letting you define a service and maintenance regimen that reflects your own individual requirements, the system builds the basis for trouble-free driving.

On the Control Display, you can have the remaining times or distances for selected maintenance tasks and any legally prescribed dates displayed, refer to page 88:

- ▷ Engine oil
- ▷ Brake pads: separately for front and rear
- ▷ Brake fluid
- ▷ Vehicle check
- ▷ Legally mandated inspections depending on local regulations

Service data in the remote control

Your vehicle continuously stores service-requirement information in the remote control while you are driving. Your dealership Service Advisor can read out this data from the remote control unit, and propose an optimized maintenance approach. Whenever you take your car in for servicing you should therefore give your dealership Service Advisor the remote control unit that you last used.



Make sure that the date is always set correctly, refer to page 92; otherwise, the effectiveness of Condition Based Service CBS is not assured. ◀

Service and Warranty Information Booklet for US models and Warranty and Service Guide Booklet for Canadian models

Please consult your Service and Warranty Information Booklet for US models and Warranty and Service Guide Booklet for Canadian models for additional information on service requirements.



BMW recommends that you have service and repair operations performed at your BMW center.

Take the time to ensure that these service procedures are confirmed by entries in your vehicle's Service and Warranty Information Booklet for US models and Warranty and Service Guide Booklet for Canadian models. These entries verify that your vehicle has received the specified regular maintenance. ◀

Socket for Onboard Diagnosis OBD

 The socket for onboard diagnosis should only be used by your BMW center or at a workshop that works according to BMW repair procedures with correspondingly trained personnel and by otherwise authorized personnel; otherwise, use can result in malfunctioning of the vehicle. ◀

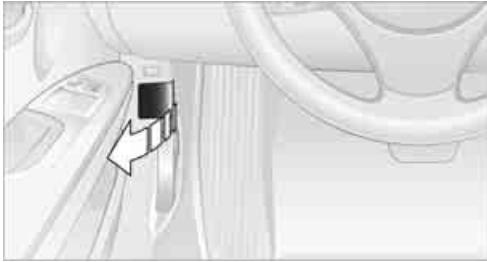

On the driver's side is an OBD socket for checking components relevant to the composition of the vehicle's emissions.

Emissions

 The warning lamp lights up: The vehicle is producing higher emissions. The trip can be continued. Have the car checked as soon as possible.



Canadian models display this warning lamp.

The lamp flashes under certain conditions. This indicates excessive misfiring in the engine. If this happens, you should reduce your speed and visit your nearest BMW center as soon as possible. Severe engine misfiring can quickly lead to serious damage of emissions-related components, especially the catalytic converter.



The warning lamp lights up if the fuel cap is not properly tightened and the OBD system assumes that fuel vapor is escaping. Make sure that the fuel cap is correctly positioned and close it until it audibly clicks.

Care

Vehicle equipment

In this chapter, all production, country, and optional equipment that is offered in the model range is described. For this reason, descriptions will be given of some equipment that may not be available in a vehicle, for example due to the special options or national-market version selected. This also applies to safety related functions and systems.

Washing the vehicle

Notes

 When using steam cleaners or high-pressure cleaning jets, make sure to maintain a sufficient distance and stay below a maximum temperature of 140°F/60 °C.

Too close a distance, too high a pressure, or too high a temperature may cause damage or preliminary damage that can then lead to long-term damage.

Follow the operating instructions for the steam jet or high-pressure washer. ◀

 When using high-pressure washers, do not spray the sensors, e.g. of the Park Distance Control, for an extended period and maintain a distance of at least 1 ft/30 cm from them. ◀

Regularly remove foreign objects, e.g. leaves, in the vicinity of the windshield when the hood is open.

Wash the vehicle more frequently, particularly in winter.

Heavy soiling and road salt can lead to vehicle damage.

Automatic car washes

Notes

 In car washes with high pressures and nozzle positions, water may drip into the vehicle around the windows. ◀

Please note the following:

- ▷ Give preference to car washes that use cloth or soft brushes in order to avoid paint damage.
- ▷ Wheels and tires must not be damaged by transport devices.
- ▷ Fold in exterior mirror, refer to page 55; otherwise, they can be damaged due to the width of the vehicle.
- ▷ Deactivate the rain sensor, refer to page 73, to prevent undesired wiper operation.
- ▷ Remove additional add-on parts, e.g. spoilers or phone antennas, if they could be damaged.
- ▷ Unscrew the rod antenna.
- ▷ Leave the remote control in the ignition lock.

 Avoid car washes with guide rail heights over 4 in/10 cm, otherwise there is danger of damaging chassis parts. ◀

Convertible: retractable hardtop

Proceed as you would in a normal car wash.

 When you open a wet hardtop, water drops may run into the trunk. If necessary, remove items from the trunk beforehand to avoid water stains or soiling. ◀

Driving into an automatic car wash

Perform the following steps to ensure that the vehicle can roll:

Manual transmission:

1. Shift into neutral.
2. Release parking brake, refer to page 64.
3. Switch off the engine.
4. Leave the remote control in the ignition lock.

Automatic transmission:

1. Insert the remote control into the ignition lock, even with Comfort Access.
2. Shift selector lever into position N.
3. Release parking brake, refer to page 64.
4. Switch off the engine.
5. Leave the remote control in the ignition lock.

Sport automatic transmission with double clutch:

Before driving into an automatic car wash, perform the following steps to ensure that the vehicle can roll:

1. Insert the remote control into the ignition lock, even with Comfort Access.
2. Engage transmission position N.
3. Release parking brake, refer to page 64.
4. Switch off the engine.
5. Leave the remote control in the ignition lock so that the vehicle can roll.

The transmission is switched into position P:

- ▷ Automatically after approx. 30 minutes
- ▷ If you remove the infrared remote control from the ignition lock

Headlamps

After washing the vehicle

 After washing the vehicle, apply the brakes briefly to dry them; otherwise, water can reduce braking efficiency over the short term and the brake discs can corrode. ◀

Remove residues on the windows completely in order to prevent impaired vision due to smear formation and to reduce wiper noise and wiper blade wear.

Vehicle care

Care products

BMW recommends using BMW cleaning and care products since they have been tested and approved for this purpose.

 Follow the instructions on the packaging. When cleaning inside the vehicle, always open the doors and windows. Only use products designed for cleaning vehicles. Cleaning agents can contain substances that are dangerous or hazardous to your health. ◀

Vehicle paintwork

Regular care contributes to driving safety and value retention. Environmental influences in regions with elevated levels of air pollution or natural contaminants such as tree sap or pollen can impact vehicle paintwork. The frequency and scope of car care should be adapted accordingly.

Immediately remove particularly corrosive substances such as spilled fuel, oil, grease, or bird droppings to prevent damage to the paintwork.

Leather care

Frequently remove dust from the leather using a cloth or vacuum cleaner.

Otherwise, dust and road grit in the pores and folds of the leather will otherwise have an abrasive effect, resulting in increased wear and causing the leather surface to become brittle prematurely.

In order to prevent staining, e.g. due to clothing, clean the leather approximately every two months.

Clean light-colored leather more frequently as it shows dust and dirt more noticeably.

Use BMW Premium Leather Care since dirt and grease will otherwise slowly affect the protective layer of the leather.

Suitable care products are available at your BMW center.

Upholstery care

Regularly vacuum with a vacuum cleaner.

To remove severe spots such as beverage stains, use a soft sponge or lint-free microfiber cloth and suitable interior cleaners.

Clean the upholstery down to the seams using a sweeping motion. Avoid strong rubbing.

 Opened Velcro fasteners on pants or other articles of clothing can damage the seat covers. Ensure that Velcro fasteners are closed. ◀

Care of special parts

Light-alloy wheels

When cleaning on the vehicle, use only neutral rim cleaner with a pH value of 5 to 9. Do not use coarse cleansers and do not use steam cleaners at temperatures greater than 140 °F /60 °C. Follow manufacturer's instructions.

Aggressive, acid-containing, or strongly alkaline cleaning agents can destroy the protective coating of nearby components such as the brake discs.

Chrome look surfaces

Carefully clean vehicle parts such as the radiator grill or door handles with copious quantities of water and possibly a shampoo additive, particularly when roads are treated with deicing salt.

Rubber parts

Treat only with water or rubber care products. Do not use silicon-containing care products on rubber seals; otherwise, noise and damage could occur.

Fine wood parts

Clean fine wood trim and fine wood parts only with a damp cloth. Wipe dry with a soft cloth.

Plastic parts

These include:

- ▷ Imitation leather surfaces
- ▷ Roofliner
- ▷ Lamp glasses
- ▷ Display pane of instrument cluster
- ▷ Parts spray painted matte black
- ▷ Painted parts in the passenger compartment

Use a microfibre cloth for cleaning.

Moisten the cloth slightly with water.

Do not soak the roofliner.

 Do not use any cleaners that contain alcohol or solvents such as lacquer thinner, cold cleaning agents, fuel, and the like; otherwise, you may damage the surfaces. ◀

Safety belts

Dirty belt straps impede the reeling action and thus have a negative impact on safety.

 Do not clean chemically, as this may destroy the webbing. ◀

Only clean with a mild soap solution in the installed state.

Only reel in seat belts when they are dry.

Carpet and floor mats

 Keep floor mats, carpet, and other objects out of the movement range of the pedals; otherwise, they may inhibit the function of the pedals during driving.

Do not place additional floor mats onto an existing one or onto other objects.

Only use floor mats that have been approved for the vehicle and can be appropriately fastened. Make sure that the floor mats are securely fastened again after they have been removed, e.g. for cleaning. ◀

Floor mats can be removed for the cleaning of the passenger compartment.

When inserting the floor mats, secure them again to prevent slippage.

When carpets are heavily soiled, clean with a microfibre cloth and water or textile cleaner. When doing so, rub back and forth in the direction of travel; otherwise, the carpet may become matted.

Sensors/cameras

Use a microfibre cloth moistened with some glass cleaner for cleaning sensors or cameras.

Displays/screens

Use an antistatic microfibre cloth for cleaning displays.



Do not use chemical or abrasive household cleaning agents. Keep all types of fluid and moisture away from the device. Otherwise, surfaces or electrical components may be corroded or damaged. When cleaning, avoid excessive pressure and do not use abrasive materials; otherwise, you may damage them. ◀

Vehicle storage

Your BMW center will be happy to advise you on preparatory steps for parking the vehicle for more than three months.

Replacing components

Vehicle equipment

In this chapter, all production, country, and optional equipment that is offered in the model range is described. For this reason, descriptions will be given of some equipment that may not be available in a vehicle, for example due to the special options or national-market version selected. This also applies to safety related functions and systems.

Onboard vehicle tool kit

Coupe



The onboard vehicle tool kit is stored in a compartment on the right-hand side of the trunk. Remove the cover.

Convertible

The onboard vehicle tool kit is stored in a pouch under the trunk floor panel.

Wiper blades

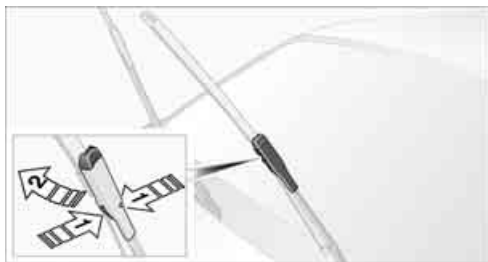

1. Fold out the wiper arm and hold it.
2. Press together the locking spring, arrows **1**, and fold out the wiper blade, arrow **2**.
3. Take the wiper blade out of the catch mechanism, pulling the blade toward the front.

 To avoid damage, make sure that the wiper arms are against the windshield before you open the hood. ◀

Lamps and bulbs

Lamps and bulbs make an essential contribution to vehicle safety. They should, therefore, be handled carefully. BMW recommends having your BMW center perform any work that you do not feel competent to perform yourself or that is not described here.

 Never touch the glass of new bulbs with your bare fingers, as even minute amounts of contamination will burn into the bulb's surface and reduce its service life. Use a clean tissue, cloth or something similar, or hold the bulb by its base. ◀

Replacement bulb sets are available at your BMW center.

 Only change bulbs while they are cool to the touch; otherwise, you could suffer burns. ◀

! When working on electrical systems, always begin by switching off the consumer in question; otherwise, short-circuits could result. To avoid possible injury or equipment damage when replacing bulbs, observe any instructions provided by the bulb manufacturer. ◀

For care of the headlamps, please follow the instructions in the chapter entitled 'Care'.

▷ To replace lamps not described here, please contact your BMW center. ◀

Light-emitting diodes LED

Light-emitting diodes installed behind translucent lenses serve as the light source for many of the controls, displays, and equipment in your vehicle. These light-emitting diodes, which operate using a concept similar to that applied in conventional lasers, are officially designated as Class 1 light-emitting diodes.

! Do not remove the covers or expose the eyes directly to the unfiltered light source for several hours; otherwise, this could cause irritation of the retina. ◀

Headlight lenses

In cool or humid weather, condensation may form on the interior of outside lamps. The condensation will disappear after a short time when driving with the headlamps switched on. The headlamp glasses do not need to be changed.

If the headlamps do not defrost despite driving with the headlamps switched on, and additional moisture builds up, for example water droplets in the lamps, have them checked by your BMW center.

Xenon lamps

These bulbs have a very long service life and are highly unlikely to fail. If a xenon lamp fails nevertheless, switch on the fog lamps and continue the journey with great care, provided that local legislation does not prohibit this.

! Have all work on the xenon lamp system, including bulb replacements, performed only by your BMW center. Due to high voltage, there is a risk of fatal injury if work on the xenon lamps is carried out improperly. ◀

Access to the lamps

1. Switch off the lamps and take the remote control out of the ignition lock.
2. Remove the upper cover from the headlamp. To do so, use a screwdriver to press the catches towards the rear, see arrows, and pull the cover forward and out.

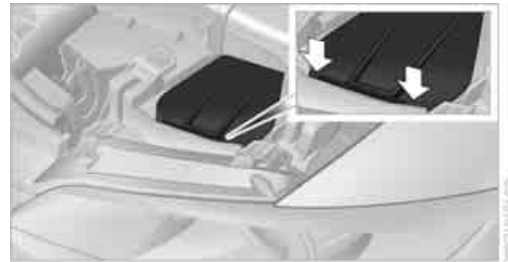

Follow the same steps in reverse order to reattach the cover.

! Be careful when installing the cover; otherwise, leaks could occur and cause damage to the headlamp system. ◀

Parking lamps and roadside parking lamps, daytime running lights

These lamps use LED technology for operation. If they malfunction, please contact your BMW center.

Corner-illuminating lamps

H3 bulb, 55 watts

1. Switch off the lamps and take the remote control out of the ignition lock.
2. Remove the cover, refer to Access to the lamps.

- Push the wire bracket out of the anchor towards the right and fold it up.



- Disconnect the plug, change the bulb and reconnect the plug.
- Insert the bulb.
- Fold the wire bracket down and engage it.
- Reattach the cover.

Turn signals, front

These lamps use LED technology for operation. If they malfunction, please contact your BMW center.

Side turn signals

W5W bulb, 5 watts

- Press the front edge of the lamp toward the rear with your fingertip, arrow **1** and pivot it out, arrow **2**.

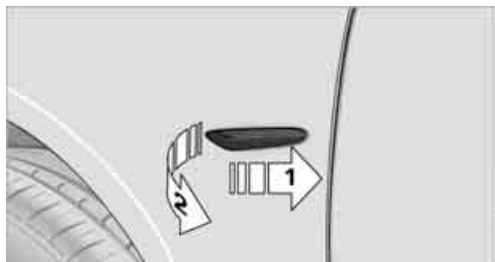

- While simultaneously lifting the retaining tab, rotate bulb holder to the left and remove.
- Remove lamp and replace it.

To install, insert rear end of the lamp and press into place at the front.

Tail lamps

Coupe: overview

The tail lamps are divided in two parts. One part is in the trunk lid, the other is in the fender.

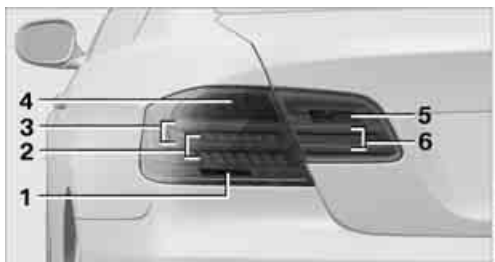

- Backup lamp
- Brake lamp
- Parking/tail lamps
- Turn signal
- Brake Force Display lamp
- Parking/tail lamps

Convertible: overview

The tail lamps are divided in two parts. One part is in the trunk lid, the other is in the fender.

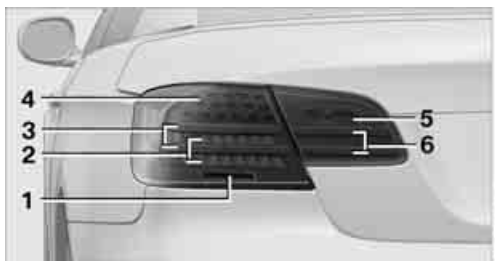

- Backup lamp
- Brake lamp
- Parking/tail lamps
- Turn signal
- Brake Force Display lamp
- Parking/tail lamps

Backup lamp

If these lamps malfunction, please contact your BMW center.

Turn signal, brake, license plate, parking, and tail lamps

These lamps use LED technology for operation. If they malfunction, please contact your BMW center.

Coupe: brake Force Display lamp in the trunk lid

H21W bulb, 21 watts

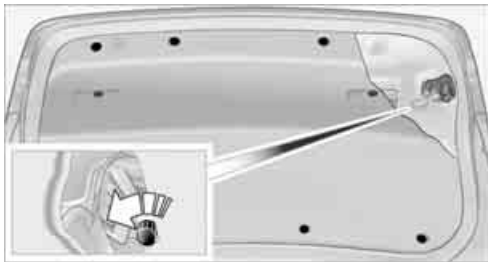

1. Pry out the plastic plugs in the trim of the trunk lid using a screwdriver and remove the trim.
2. Release the bulb holder, see arrow, and remove.
3. Apply gentle pressure to the bulb while turning it to the left for removal and replacement.
4. Attach the bulb holder.
5. Attach trunk lid trim.

Convertible: brake Force Display lamp in the trunk lid

H21W bulb, 21 watts

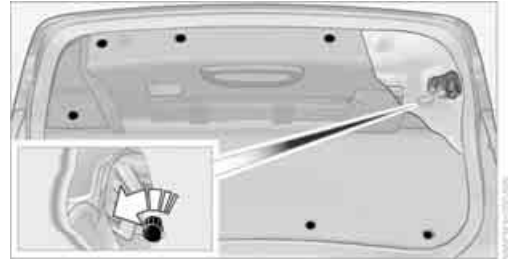

1. Take the warning triangle out of its holder, refer to page 273. Unscrew the holder using the screwdriver from the onboard vehicle tool kit.
2. Pry out the plastic plugs in the trim of the trunk lid using a screwdriver and remove the trim.
3. Release the bulb holder, see arrow, and remove.
4. Apply gentle pressure to the bulb while turning it to the left for removal and replacement.
5. Attach the bulb holder.
6. Reattach the trim of the trunk lid and the holder for the warning triangle.

Changing wheels

Your BMW is equipped with run-flat tires as standard. This eliminates the need to change a wheel immediately in the event of a puncture.

For information on continuing to drive with a damaged tire, refer to Indication of a flat tire on page 101.

The symbol identifying run-flat tires is a circle with the letters RSC on the sidewall, refer to Run-flat tires, page 252.

When mounting new tires or changing over from summer to winter tires and vice versa, mount run-flat tires for your own safety. In the event of a flat, no spare wheel is available. Your BMW center will be glad to advise you. Refer also to New wheels and tires, page 252.

 The tools for changing wheels are available as optional accessories from your BMW center. ◀

Jack mounting points

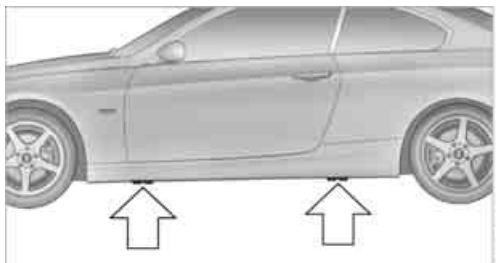

The jacking points are at the positions shown in the illustration.

Vehicle battery

Battery care

The battery is 100% maintenance-free, the electrolyte will last for the life of the battery when the vehicle is operated in a temperate climate. Your BMW center will be glad to advise in all matters concerning the battery.

Battery replacing

 Only use vehicle batteries that have been approved for your vehicle by the manufacturer; otherwise, the vehicle could be damaged and systems or functions may not be fully available. ◀

After a battery replacement, have the battery registered on the vehicle by your service center to ensure that all comfort functions are fully available.

Charging the battery

Note

 Do not connect battery chargers to the sockets installed in the vehicle at the factory; otherwise you may cause damage to the battery. ◀

General information

To guarantee the full service life of the battery, ensure that the battery is always properly charged.

It may be necessary to charge the battery in the following situations:

- ▷ If frequent short trips are taken;
- ▷ If the vehicle is frequently parked for more than a month.

Jump-starting terminals

Only charge the battery in the vehicle via the terminals in the engine compartment with the engine off. Connections, refer to Jump starting on page 274.

Power failure

After a temporary power loss, the functioning of some equipment may be limited and require reinitialization. Individual settings may likewise have been lost and will have to be programmed:

- ▷ Time and date
These values must be updated, refer to page 90.
- ▷ Radio
In some cases, stations may have to be stored again, refer to page 170.
- ▷ Navigation system
You must wait until the system becomes functional again.
- ▷ Glass roof
It may happen that the roof can only be tilted. The system must be initialized. Please contact your BMW center.

- ▷ **Seat and mirror memory**
The positions must be stored again, refer to page 53.
- ▷ **Inside rearview mirror with digital compass**
The system must be calibrated, refer to page 123.
- ▷ **Active steering**
The system automatically initializes itself briefly during a trip. The system is deactivated during this time, refer to page 105.
- ▷ **xDrive**
The system automatically initializes itself during a trip. Indicator lamps light up during this time. If the lamps do not go out during the current trip, have the system checked.

Disposal of old battery



Have old batteries disposed of by your BMW center or bring them to a recycling center. Maintain the battery in an upright position for transport and storage. Always secure the battery against tipping over during transport. ◀

Fuses



Never attempt to repair a blown fuse and do not replace a defective fuse with a substitute of another color or amperage rating; otherwise, this could lead to a circuit overload, ultimately resulting in a fire in the vehicle. ◀



Open the cover in the glove compartment and remove it.

Plastic tweezers are located on the distributor box.

See the rear of the cover for information on fuse assignment.

Spare fuses are available at your BMW center.

Giving and receiving assistance

Vehicle equipment

In this chapter, all production, country, and optional equipment that is offered in the model range is described. For this reason, descriptions will be given of some equipment that may not be available in a vehicle, for example due to the special options or national-market version selected. This also applies to safety related functions and systems.

Emergency Request

Requirements

- ▷ Full preparation package mobile phone: this equipment makes it possible to send an Emergency Request even if no mobile phone is paired with the vehicle.
- ▷ BMW Assist is activated.
- ▷ Radio readiness is switched on.
- ▷ The BMW Assist system is logged into a mobile phone network that is supported by BMW Assist.
- ▷ The Emergency Request system is operable.

Only press the SOS button in an emergency.

 For technical reasons, the Emergency Request service cannot be guaranteed for the most unfavorable conditions. ◀

Subscriber contract

Upon expiration of the subscriber contract with BMW Assist, the BMW Assist system can be deactivated by a BMW center without a workshop visit.

After the system is deactivated, it is no longer possible to make Emergency Requests.

It may be possible for a BMW center to reactivate the system after a new contract has been signed.

Sending an Emergency Request

1. Briefly press the cover flap to open.



2. Press the SOS button until the LED in the button comes on.
- ▷ The LED comes on: the Emergency Request has been triggered.

If the circumstances allow, remain in the vehicle until the voice contact has been established.

- ▷ The LED flashes when the connection to the BMW Assist Response Center has been established.

Once the BMW Assist Response Center has received your Emergency Request, the BMW Assist Response Center contacts you and takes further steps to help you. Even if you are unable to respond, the BMW Assist Response Center will be able to initiate further steps to assist you under certain conditions.

Data for determining the necessary rescue measures are transmitted to the BMW Assist Response Center, e.g. the current position of your vehicle, if it can be determined.

- ▷ If the LED is flashing but the BMW Assist Response Center cannot be heard over the hands-free system, it is possible that the hands-free system is malfunctioning. The BMW Assist Response Center may still be able to hear you, however.

Automatically triggering an Emergency Request

Under certain conditions, an Emergency Request is sent automatically immediately after a severe accident. An automatic Emergency Request is not affected by pressing the SOS button.

Roadside Assistance

BMW Roadside Assistance is available by phone around the clock in many countries. You can obtain support there in the event of a breakdown.

First aid pouch

Some of the articles contained in the first aid pouch have a limited service life. Therefore, check the expiration dates of the contents regularly and replace any items in good time, if necessary.

Coupe



The first aid pouch is located on the right-hand side of the trunk in a storage area.

Convertible



The first aid pouch is located in a compartment under the front passenger seat.

To open: press the button and fold the cover down.

To close: fold the cover back up and press it into the catch.

Warning triangle

Coupe

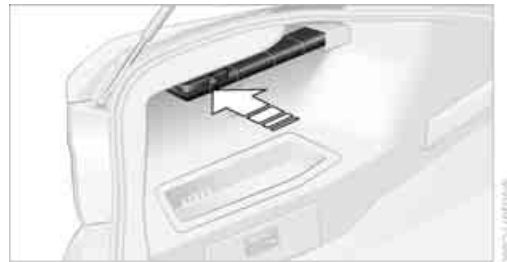

The warning triangle is located on the left-hand side of the trunk. Press the tab to take it out.

Convertible

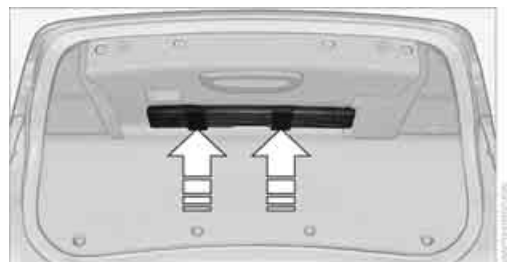

The warning triangle is located in a holder in the trunk lid. Press the tabs to take it out.

Jump starting

If the car's own battery is flat, your BMW's engine can be started by connecting two jumper cables to another vehicle's battery. You can also use the same method to help start another vehicle. Only use jumper cables with fully-insulated clamp handles.

 Do not touch any electrically live parts when the engine is running, or a fatal accident may occur. Carefully adhere to the following sequence, both to prevent damage to one or both vehicles, and to guard against possible personal injuries. ◀

Preparation

1. Check whether the battery of the other vehicle has a voltage of 12 volts and approximately the same capacitance in Ah. This information can be found on the battery.
2. Switch off the engine of the assisting vehicle.
3. Switch off any consumers in both vehicles.

 There must not be any contact between the bodies of the two vehicles; otherwise, there is a danger of shorting. ◀

Connecting jumper cables

 Connect the jumper cables in the correct order, so that no sparks which could cause injury occur. ◀

Your BMW has a jump-starting connection in the engine compartment which acts as the battery's positive terminal, refer also to the Engine compartment overview on page 255. The cap is marked with +.

1. Pull the cap of the BMW jump-starting connection up to remove.



2. Attach one terminal clamp of the plus/+ jumper cable to the positive terminal of the battery or a starting-aid terminal of the vehicle providing assistance.
3. Attach the second terminal clamp of the plus/+ jumper cable to the positive terminal of the battery or a starting-aid terminal of the vehicle to be started.
4. Attach one terminal clamp of the minus/- jumper cable to the negative terminal of the battery or to an engine or body ground of the assisting vehicle. Your BMW has a special nut as body ground or negative pole.



5. Attach the second terminal clamp of the minus/- jumper cable to the negative terminal of the battery or to the engine or body ground of the vehicle to be started.

Starting the engine

1. Start the engine of the donor vehicle and allow it to run for a few minutes at slightly increased idle speed.
2. Start the engine on the other vehicle in the usual way.
If the first start attempt is not successful, wait a few minutes before another attempt in order to allow the discharged battery to recharge.
3. Let the engines run for a few minutes.
4. Disconnect the jumper cables by reversing the above connecting sequence.

If necessary, have the battery checked and recharged.

 Never use spray fluids to start the engine. ◀

Tow-starting, towing away

 Observe the applicable laws and regulations for tow-starting and towing vehicles. ◀

 Do not transport any passengers other than the driver in a vehicle that is being towed. ◀

Using a tow fitting

The screw-in tow fitting must always be carried in the car. It can be screwed in at the front or rear of the BMW.

Coupe: it is stored in the onboard vehicle tool kit underneath the cover on the right-hand side of the trunk, refer to page 266.

Convertible: it is stored in the onboard vehicle tool kit underneath the trunk floor, refer to page 266.

 Use only the tow fitting provided with the vehicle and screw it all the way in. Use the tow fitting for towing on paved roads only. Avoid lateral loading of the tow fitting, e.g. do not lift the vehicle by the tow fitting. Otherwise, the tow fitting and the vehicle could be damaged. ◀

Access to screw thread

Release the cover panel in the bumper:
Press on the upper part of the cover panel.

Front

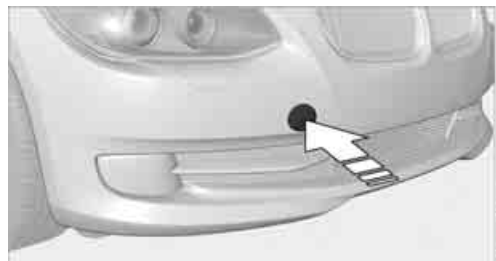

Rear

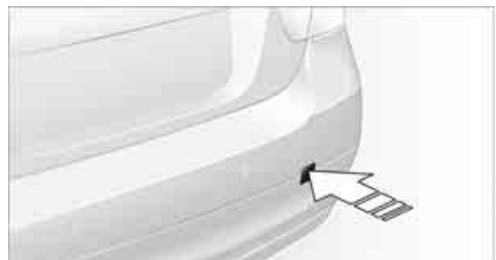

Being towed

 Make sure that the ignition is switched on, refer to page 62; otherwise, the low-beam headlamps, tail lamps, turn signal indicators and windshield wipers may be unavailable.

Power steering assistance is not available when the engine is not running. Thus, braking and steering will require increased effort. Active steering is not active and it will be necessary to turn the steering wheel further. ◀

Manual transmission

Gearshift lever in neutral position.

Automatic transmission

Selector lever in position N.

Changing selector lever positions, refer to page 65.

 Do not exceed a towing speed of 45 mph or 70 km/h and a towing distance of 90 miles/150 km; otherwise, the automatic transmission may be damaged. ◀

Sport automatic transmission with double clutch

 Make sure that the parking lock P is not engaged; otherwise, the rear wheels are immobilized.

When using the car wash function, refer to page 263, note that the parking lock P is engaged automatically after approx.

30 minutes, blocking the rear wheels.

In the event of an electrical malfunction or if the vehicle must be towed for more than approx. 20 minutes, unlock the parking lock manually, refer to page 70. ◀

 When towing, do not exceed a maximum speed of 30 mph or 50 km/h and a maximum distance traveled of 30 miles/50 km; otherwise, the transmission may be damaged. ◀

Towing methods

 Do not lift the vehicle by a tow fitting or body and chassis parts; otherwise, damage may result. ◀

With a tow bar

 The towing vehicle must not be lighter than the towed vehicle; otherwise, it may be impossible to maintain control. ◀

The tow fittings used should be on the same side on both vehicles. Should it prove impossible to avoid mounting the tow bar at an angle, please observe the following:

- ▷ Clearance and maneuvering capability will be sharply limited during cornering.
- ▷ The tow bar will generate lateral forces if it is attached offset.

 Attach the tow bar to the tow fittings only, as attaching it to other parts of the vehicle could result in damage. ◀

With a tow rope

When starting off in the towing vehicle, make sure that the tow rope is taut.

 To avoid jerking and the associated stresses on vehicle components when towing, always use nylon ropes or nylon straps. Attach the tow rope to the tow fittings only, as attaching it to other parts of the vehicle could result in damage. ◀

With a tow truck: vehicle without xDrive

Manual and automatic transmission:

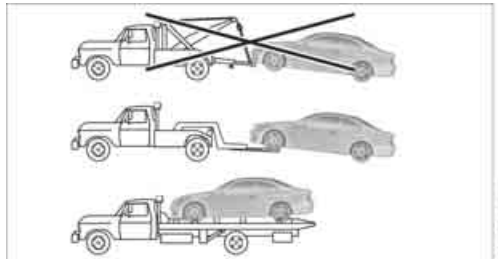

Sport automatic transmission with double clutch:

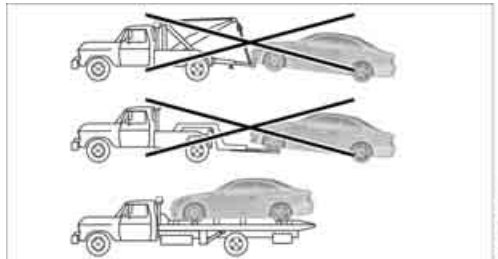

Have the BMW transported with a tow truck with a so-called lift bar, or on a flatbed.

Do not tow the vehicle with just the rear axle raised as this may cause the steering to turn.

With a tow truck: vehicle with xDrive

 Do not tow a BMW with xDrive with just the front or rear axle raised; otherwise, the wheels could lock up and the transfer case could be damaged. ◀

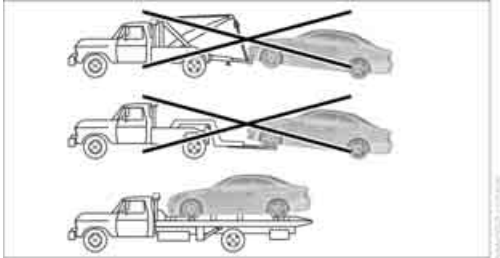

Have the BMW transported on a flatbed surface only.

Tow-starting

Avoid tow-starting the vehicle whenever possible; instead, jump start the engine, refer to page 274. Vehicles with a catalytic converter should only be tow-started when the engine is cold, vehicles with an automatic transmission or Sport automatic transmission with double clutch cannot be tow-started at all.

1. Switch on hazard warning flashers, comply with local regulations.
2. Switch on the ignition, refer to page 62.
3. Shift into 3rd gear.
4. Have the vehicle tow-started with the clutch depressed and slowly release the clutch. After the engine starts, immediately depress the clutch completely again.
5. Stop at a suitable location, remove the tow bar or rope and switch off the hazard warning flashers.
6. Have the vehicle checked.

 With xDrive: do not activate Hill Descent Control HDC when the vehicle is being tow-started, page 99. ◀



Reference

This chapter contains technical data, short commands for the voice activation system and an index that will help you find information most quickly.

Technical data

Vehicle equipment

In this chapter, all production, country, and optional equipment that is offered in the model range is described. For this reason, descrip-

tions will be given of some equipment that may not be available in a vehicle, for example due to the special options or national-market version selected. This also applies to safety related functions and systems.

Dimensions

Coupe		
Width with mirrors	in/mm	77.2/1,961
Width without mirrors	in/mm	70.2/1,782
Height	in/mm	54.9/1,395
Height, 335is	in/mm	54.1/1,375
Length	in/mm	181.9/4,620
Wheelbase	in/mm	108.7/2,760
Smallest turning circle dia. (with xDrive)	ft/m	36.1/11.0 (38.7/11.8)

Convertible		
Width with mirrors	in/mm	77.2/1,961
Width without mirrors	in/mm	70.2/1,782
Height	in/mm	54.5/1,384
Height, 335is	in/mm	53.9/1,370
Length	in/mm	181.9/4,620
Wheelbase	in/mm	108.7/2,760
Smallest turning circle dia.	ft/m	36.1/11.0

Weights

Coupe

		328i	328i xDrive	335i	335i xDrive
Approved gross weight					
▷ with manual transmission	lbs/kg	4,288/1,945	4,508/2,045	4,486/2,035	4,663/2,115
▷ with automatic transmission	lbs/kg	4,354/1,975	4,553/2,065	4,508/2,045	4,685/2,125
Load	lbs/kg	882/400	882/400	882/400	882/400
Approved front axle load	lbs/kg	2,061/935	2,227/1,010	2,172/985	2,326/1,055
Approved rear axle load	lbs/kg	2,425/1,100	2,447/1,110	2,469/1,120	2,513/1,140
Approved roof load capacity	lbs/kg	165/75	165/75	165/75	165/75
Trunk capacity	cu ft/ liters	15.5/440	15.5/440	15.2/430	15.2/430

				335is
Approved gross weight				
▷ with manual transmission	lbs/kg			4,497/2,040
▷ Sport automatic transmission with double clutch	lbs/kg			4,519/2,050
Load	lbs/kg			882/400
Approved front axle load	lbs/kg			2,183/990
Approved rear axle load	lbs/kg			2,513/1,140
Approved roof load capacity	lbs/kg			165/75
Trunk capacity	cu ft/ liters			15.2/430

Convertible

		328i	335i	335is
Approved gross weight				
▷ with manual transmission	lbs/kg	4,707/2,135	4,817/2,185	4,839/2,195
▷ with automatic transmission	lbs/kg	4,773/2,165	4,839/2,195	–
▷ Sport automatic transmission with double clutch	lbs/kg	–	–	4,872/2,210
Load	lbs/kg	838/380	838/380	838/380
Approved front axle load	lbs/kg	2,138/970	2,205/1,000	2,227/1,010
Approved rear axle load	lbs/kg	2,646/1,200	2,646/1,200	2,646/1,200
Approved roof load capacity	lbs/kg	–	–	–
Trunk capacity	cu ft/ liters	7.4-12.4/ 210-350	7.4-12.4/ 210-350	7.4-12.4/ 210-350

Capacities

				Notes
Fuel tank	US gal/liters	approx. 16.1/61	Fuel recommendations:	
including reserve of	US gal/liters	approx. 2.1/8.0		page 233

Short commands for the voice activation system

Vehicle equipment

In this chapter, all production, country, and optional equipment that is offered in the model range is described. For this reason, descriptions will be given of some equipment that may not be available in a vehicle, for example due to the special options or national-market version selected. This also applies to safety related functions and systems.

General information

For instructions on the voice activation system, refer to page 27.

Having the possible spoken commands read aloud: ›Voice commands‹.

The following short commands are for vehicles with the voice activation system. They do not function with equipment packages that permit only the mobile phone to be operated by voice.

Useful short commands

Function	Command
Opening a music collection	›Music collection‹
Opening the tone control	›Tone‹
Opening the settings	›Settings‹
Accessing the onboard computer	›Onboard info‹
Opening the contacts	›Contacts‹
Displaying phone book	›Phonebook‹
Accessing services	›Assist‹
Accessing BMW Assist	›B M W Assist‹
Accessing ConnectedDrive	›Connected Drive‹
Opening the home address	›Home address‹
Opening destination entry	›Enter address‹
Opening destination guidance	›Guidance‹

CD/Multimedia

CD/DVD drive

Function	Command
Selecting a track	›Track ...‹ e.g. track 5 or ›C D track ...‹ e.g. CD track 5
Playing back a CD	›C D on‹
Selecting a CD	›Select C D‹
Selecting a CD and track	›C D ... track ...‹ e.g. CD 3 track 5
Opening the CD and Multimedia menu	›C D and multimedia‹
CD and DVD	›C D‹
Displaying entertainment details on the split screen	›Entertainment details‹

Music collection

Function	Command
Searching for music; opening the menu	›Music search‹
Calling up the current playback	›Current playback‹
Opening a music collection	›Music collection‹
Playing back a music collection	›Music collection on‹
Playing back the most frequently played tracks	›Top fifty‹

External devices

Function	Command
Opening external devices	›External devices‹
Accessing Bluetooth devices	›Bluetooth‹
AUX front	›AUX‹

Tone control

Function	Command
Opening the tone control	›Tone‹

Radio

FM

Function	Command
Selecting a station directly	›Station ...‹ e.g. National Public Radio
Calling up the radio	›Radio‹
Calling up an FM station	›F M‹
Opening manual search	›Manual‹
Selecting the frequency range	›Select frequency‹
Calling up a station	›Select station‹

AM

Function	Command
Calling up an AM station	›A M‹
Opening manual search	›Manual‹

Satellite radio

Function	Command
Calling up the satellite radio	›Satellite radio‹
Switching on the satellite radio	›Satellite radio on‹
Selecting a satellite radio channel	›Select satellite radio‹ e.g. channel 2

Presets

Function	Command
Opening the stored stations	›Presets‹
Choosing a stored station	›Select preset‹
Selecting a stored station	›Preset ...‹ e.g. stored station 2

Telephone

Function	Command
Dialing a phone number	›Dial number‹
Opening the Telephone menu	›Telephone‹
Displaying phone book	›Phonebook‹
Redialing	›Redial‹
Displaying accepted calls	›Received calls‹
Displaying the list of messages	›Messages‹
Displaying Bluetooth devices	›Bluetooth‹

Office

Function	Command
Opening Office menu	›Office‹
Displaying current Office	›Current office‹
Displaying contacts	›Contacts‹
Displaying messages	›Messages‹
Displaying calendar	›Calendar‹
Displaying tasks	›Tasks‹
Displaying reminders	›Reminders‹

Contacts

Function	Command
Select a name	›Choose name‹
Opening the contacts	›Contacts‹
My contacts	›My contacts‹
New contact	›New contact‹

Navigation

General information

Function	Command
Navigation menu	›Navigation‹
Opening destination entry	›Enter address‹
Entering an address	›Enter address‹
Opening destination guidance	›Guidance‹
Starting destination guidance	›Start guidance‹
Ending destination guidance	›Stop guidance‹
Opening the home address	›Home address‹
Opening the route criteria	›Route preference‹
Opening the route	›Route information‹
Switching on the voice instructions	›Switch on voice instructions‹
Repeating a voice instruction	›Repeat voice instructions‹
Switching off the voice instructions	›Switch off voice instructions‹
Displaying the address book	›Address book‹
Displaying the last destinations	›Last destinations‹
Opening the traffic bulletins	›Traffic Info‹
Special destinations	›Points of interest‹

Map

Function	Command
Displaying the map	›Map‹
Map facing north	›Map facing north‹
Map in the direction of travel	›Map in direction of travel‹
Perspective map	›Map perspective view‹
Automatic map scaling	›Map with automatic scaling‹
Changing the scale	›Map scale‹
Scale...meters	›Map scale ... meters‹ e.g. map scale of 100 meters
Scale...kilometers	›Map scale ... kilometers‹ e.g. split screen scale of 5 kilometers

Split screen settings

Function	Command
Split screen	›Switch on split screen‹
Switching off the split screen	›Turn off split screen‹
Adapting the split screen	›Split screen content‹
Split screen, current position	›Split screen current position‹
Split screen, map facing north	›Split screen map facing north‹
Split screen, direction of travel	›Split screen map in direction of travel‹
Split screen, perspective	›Split screen perspective‹
Expanded intersection zoom on the split screen	›Split screen Exit ramp view‹
Split screen scale ... meters	›Split screen scale ... meters‹ e.g. split screen scale of 100 meters
Split screen scale ... kilometers	›Split screen scale ... kilometers‹ e.g. split screen scale of 5 kilometers
Split screen, highlighting traffic bulletins	›Split screen, Traffic conditions‹
Split screen, computer	›Split screen on board info‹
Split screen, trip computer	›Split screen trip computer‹
Automatically scaling the split screen	›Split screen automatic scaling‹

Destination guidance with intermediate destinations

Function	Command
Entering a new destination	›Enter address‹
Trip list	›Stored trips‹

Contacts

Function	Command
Opening the contacts	›Contacts‹
My contacts	›My contacts‹
New contact	›New contact‹

ConnectedDrive or BMW Assist

Function	Command
Accessing BMW Assist	›B M W Assist‹
Accessing ConnectedDrive	›Connected Drive‹
Accessing BMW Online	›B M W Online‹

Vehicle information

Function	Command
Accessing the onboard computer	›Onboard info‹
Opening the trip computer	›Trip computer‹
Opening the vehicle information	›Vehicle info‹
Opening the vehicle status	›Vehicle status‹

Settings

Vehicle

Function	Command
Opening the main menu	›Main menu‹
Opening the settings	›Settings‹
Opening the options	›Options‹
Settings on the Control Display	›Control display‹
Opening the time and date settings	›Time and date‹
Opening the language and unit settings	›Language and units‹
Opening the speed limit settings	›Speed‹
Opening the light settings	›Lighting‹
Opening the door lock settings	›Door locks‹
Opening profiles	›Profiles‹

Equipment

Function	Command
Opening the air conditioning settings	›Climate‹

Everything from A to Z

Index

A

- ABS Antilock Brake System **97**
- ACC, refer to Active Cruise Control **76**
- Acceleration assistant, refer to Launch Control **71**
- Accessories, refer to Vehicle equipment **5**
- Accident, refer to Sending an Emergency Request **272**
- Activated-charcoal filter for automatic climate control **119**
- Active Cruise Control **76**
 - indicator lamp **79**
 - malfunction **80**
 - selecting distance **78**
 - sensor **80**
- Active steering **105**
- Adaptive brake light
 - brake force display **106**
- Adaptive Light Control **111**
- Additives
 - coolant **259**
 - engine oil **258**
- Address, entering **146, 152**
- Address for navigation
 - entering **146**
- Adjusting temperature inside the car, refer to Automatic climate control **116**
- Adjusting the thigh support **49**
- Airbags **107**
 - indicator/warning lamp **108**
 - sitting safely **48**
- Air conditioning mode
 - automatic climate control **116**
 - ventilation **118**
- Air distribution
 - automatic **116**
- Airing, refer to Ventilation **118**
- Air pressure, refer to Tire inflation pressure **235**
- Air recirculation, refer to Recirculated air mode **117**
- Air supply
 - automatic climate control **116**
 - ventilation **118**
- Air vents **115**
- Air volume **117**
- AKI, refer to Fuel grade **233**
- Alarm system **38**
 - avoiding unintentional alarms **39**
 - interior motion sensor **39**
 - switching off an alarm **39**
 - tilt alarm sensor **39**
- Albums in music collection **187**
- ALL program **117**
- All-season tires, refer to Winter tires **253**
- All-wheel drive, refer to xDrive **99**
- AM, waveband **169**
- Ambient air, refer to Recirculated air mode **117**
- Antifreeze
 - coolant **259**
 - washer fluid **74**
- Antilock Brake System ABS **97**
- Anti-theft alarm system, refer to Alarm system **38**
- Appointments, refer to Calendar **219**
- Approved axle loads, refer to Weights **281**
- Approved engine oils **258**
- Approved gross vehicle weight, refer to Weights **281**
- Apps **228**
- Armrest, refer to Center armrest **124**
- Arrival time, refer to Computer **85**
- Ashtray **126**
- Assist systems, refer to Driving stability control **97**
- AUC Automatic recirculated air control **117**
- Audible instructions, refer to Voice instructions **157**
- Audio **166**
 - controls **166**
 - switching on/off **166**
 - tone control **167**
 - volume **166**
- Audio device, external **125**
- Automatic
 - air distribution **116**
 - air volume **116**
 - cruise control **74, 76**
 - headlamp control **110**
- Automatic car washes **262**
- Automatic climate control **115**
- Automatic curb monitor **56**
- Automatic high beams and low beams, refer to High-beam Assistant **112**

Automatic recirculated air control AUC [117](#)
Automatic Service Request [227](#)
Automatic transmission with Steptronic [65](#)
– interlock [65](#)
– overriding selector lever lock [67](#)
– shiftlock, refer to Changing selector lever position [65](#)
– sport program [66](#)
– towing [275](#)
– tow-starting [275](#)
AUTO program for automatic climate control [116](#)
AUX-In connection [125](#), [189](#)
Available services [228](#)
Average fuel consumption [85](#)
– setting the units [88](#)
Average speed [85](#)
Avoid highways in navigation [155](#)
Avoiding unintentional alarms [39](#)
Axle loads, refer to Weights [281](#)

B

Backing up the music collection [188](#)
Backrest contour, refer to Lumbar support [50](#)
Backrests, refer to Seat adjustment [49](#)
Backrest width adjustment [50](#)
Back seats
– refer to Rear seats [52](#)
Bag holder [129](#)
Band-aids, refer to First aid pouch [273](#)
Bar, refer to Towing methods [276](#)

Base plate for telephone or mobile phone
– refer to Snap-in adapter [211](#)
– refer to Snap-in adapter in the center armrest storage compartment [124](#)
Bass, tone control [167](#)
Battery [270](#)
– charging [270](#)
– disposal [41](#), [271](#)
– jump starting [274](#)
– remote control [32](#)
– replacing [270](#)
– temporary power failure [270](#)
Battery renewal
– remote control [41](#)
– remote control for vehicle [41](#)
Being towed [275](#)
Belt hand-over [54](#)
– pinch protection system [55](#)
Belts, refer to Safety belts [54](#)
Belt tensioner, refer to Safety belts [54](#)
Beverage holders, refer to Cupholders [125](#)
Black ice, refer to Outside temperature warning [83](#)
Blinds, refer to Roller sunblinds [124](#)
Blower, refer to Air volume [117](#)
Bluetooth, activating/deactivating [201](#)
Bluetooth audio [192](#)
– disconnecting an audio connection [195](#)
– pairing device [193](#)
– playback [194](#)
– unpairing device [195](#)
– what to do if ... [195](#)
BMW Assist [224](#)
– updating [228](#)
BMW Homepage [4](#)
BMW Info [218](#)
BMW Maintenance System [260](#)
BMW Online [226](#)

BMW webpage [4](#)
Bottle holders, refer to Cupholders [125](#)
Brake Assist, refer to Dynamic Brake Control DBC [97](#)
Brake fluid, refer to Service requirements [88](#)
Brake Force Display [106](#)
Brake lights
– brake force display [106](#)
Brake pads [136](#)
– breaking in [136](#)
Brake pedal, refer to Braking safely [138](#)
Brake rotors [139](#)
– brakes [136](#)
– breaking in [136](#)
Brakes
– ABS [97](#)
– BMW Maintenance System [260](#)
– brake force display [106](#)
– breaking in [136](#)
– parking brake [64](#)
– service requirements [88](#)
Brakes, refer to Braking safely [138](#)
Brake system [136](#)
– BMW Maintenance System [260](#)
– breaking in [136](#)
– disc brakes [139](#)
Breakdown services, refer to Roadside Assistance [273](#)
Breaking in the clutch [136](#)
Breaking in the differential, refer to Engine and differential [136](#)
Break-in period [136](#)
Brightness of the Control Display [95](#)
Bulb changing, refer to Lamps and bulbs [266](#)
Button for starting the engine, refer to Start/Stop button [62](#)
Buttons on the steering wheel [13](#)

C

Calendar **219**

– displaying appointment **219**

– selecting calendar day **219**

California Proposition **65**

warning **6**

Call

– accepting **205**

– ending **205**

– muting the microphone **207**

– rejecting **205**

Calling, refer to Phone

numbers, dialing **206**

Calling, refer to Telephone

owner's manual

Calls

– with multiple parties **206**

Can holders, refer to

Cupholders **125**

Capacities **282**

Capacity of the trunk **281**

Car battery, refer to Vehicle

battery **270**

Car care, refer to Care **262**

Care **262**

– automatic car washes **262**

– care products **263**

– carpets **264**

– chrome parts **264**

– displays **265**

– fine wood parts **264**

– headlamps **263**

– leather **263**

– light-alloy wheels **264**

– paintwork **263**

– plastic parts **264**

– retractable hardtop **262**

– rubber seals **264**

– safety belts **264**

– sensors and cameras **265**

– upholstery and cloth

trim **264**

Cargo, securing **140**

Cargo loading **139**

– securing cargo **140**

– stowing cargo **140**

– vehicle **139**

Car jack

– jacking points **270**

Car key, refer to Integrated

key/remote control **32**

Car phone

– installation location, refer to

Center armrest **124**

– refer to separate Owner's

Manual

Car phone, refer to

Telephone **200**

Car radio, refer to Radio **169**

Catalytic converter, refer to

Hot exhaust system **138**

CD, audio playback **178**

CD player **178**

– controls **166**

– fast forward/reverse **180**

– random sequence **179**

– selecting a track **178**

– switching on/off **166**

– tone control **167**

– volume **166**

Center armrest **124**

Center brake lamp

– replacing bulb **269**

Center console, refer to

Around the center

console **16**

Central locking

– from inside **36**

– from outside **33**

Central locking system **33**

– comfort access **40**

– hotel function **37**

– setting unlocking

characteristics **34**

Changes, technical, refer to

For your own safety **5**

Changing bulbs, refer to

Lamps and bulbs **266**

Changing gears **69**

Changing the language on the

Control Display **95**

Changing the measurement

units on the Control

Display **88**

Changing wheels **269**

Chassis number, refer to

Engine compartment **255**

Check Control **92**

Child restraint fixing system

LATCH **59**

Child restraint systems **58**

Child seats, refer to

Transporting children

safely **58**

Cigarette lighter, refer to

Lighter **126**

Cleaning headlamps **73**

– washer fluid **74**

Cleaning your BMW, refer to

Care **262**

Climate control

– automatic air

distribution **116**

Clock **83**

– 12h/24h mode **91**

– setting the time and date **91**

– setting time **90**

Closing

– from inside **36**

– from outside **33**

Clothes hooks **125**

Cockpit **12**

Cold start, refer to Starting the

engine **63**

Comfort Access **40**

– replacing the battery **41**

Comfort area, refer to Around

the center console **16**

Compartment for remote

control, refer to Ignition

lock **62**

Compass **122**

- Computer [85](#)
– displays on Control Display [85](#)
- Computer, refer to iDrive [20](#)
- Concierge service [225](#)
- Condensation, refer to When the vehicle is parked [139](#)
- Condition Based Service CBS [260](#)
- Configuring settings, refer to Personal Profile [32](#)
- Confirmation signals for locking/unlocking the vehicle [35](#)
- ConnectedDrive [224](#)
- Connecting a music player, AUX-In connection [189](#)
- Connecting a music player, USB audio interface [190](#)
- Connecting an iPod, refer to AUX-In connection [189](#)
- Connecting an iPod, refer to USB audio interface [190](#)
- Connecting an MP3 player, refer to AUX-In connection [189](#)
- Connecting an MP3 player, refer to USB audio interface [190](#)
- Connecting vacuum cleaner, refer to Connecting electrical appliances [127](#)
- Consumption, refer to Average fuel consumption [85](#)
- Contacts [214](#)
– deleting [216](#), [223](#)
– exporting/importing [223](#)
– new contact [215](#)
- Control Center, refer to iDrive [20](#)
- Control Display [21](#)
– switching off [21](#)
- Control Display, refer to iDrive [20](#)
– adjusting brightness [95](#)
- Controller, refer to iDrive [20](#)
- Controls and displays [12](#)
- Control unit, refer to iDrive [20](#)
- Convenient loading in Convertible [35](#)
- Convenient opening and closing
– glass roof [34](#)
– glass roof with Comfort Access [40](#)
– retractable hardtop [34](#)
– windows [34](#)
– windows with Comfort Access [40](#)
– with Comfort Access [40](#)
- Convertible
– bag holder [129](#)
– convenient loading [35](#)
– enlarging trunk [128](#)
– folding down rear backrest [128](#)
– retractable hardtop [44](#)
– rollover protection system [109](#)
– securing cargo [140](#)
– stowing cargo [140](#)
- Coolant [259](#)
– checking level [259](#)
- Coolant temperature [259](#)
- Cooling, maximum [116](#)
- Cooling fluid, refer to Coolant [259](#)
- Cooling system, refer to Coolant [259](#)
- Copyright [2](#)
- Corner-illuminating lamps
– replacing bulbs [267](#)
- Cornering light, refer to Adaptive Light Control [111](#)
- Correct tires [252](#)
- Courtesy lamps, refer to Interior lamps [114](#)
- Criteria for route [155](#)
- Cross-hairs in navigation [151](#)
- Cruise control [74](#)
– active [76](#)
– malfunction [76](#)
- Cruise control, refer to Active Cruise Control [76](#)
- Cruising range [85](#)
- Cupholders [125](#)
- Curb weight, refer to Weights [281](#)
- Current playback
– external devices [191](#)
– in music collection [186](#)
- Customer Relations [227](#)
- ## D
- Dashboard, refer to Cockpit [12](#)
- Dashboard lighting, refer to Instrument lighting [114](#)
- Data, technical
– capacities [282](#)
– dimensions [280](#)
– weights [281](#)
- Data memory [7](#)
- Data transfer [228](#)
- Date
– date format [92](#)
– setting [92](#)
- Daytime running lights [111](#)
– replacing bulbs [267](#)
- DBC Dynamic Brake Control [97](#)
- Deactivating front passenger airbags [107](#)
- Deadlocking, refer to Locking [34](#)
- Defect
– door lock [36](#)
– fuel filler flap [232](#)
- Defining a home address [215](#)
- Deleting the music collection [188](#)
- Destination, entering by town/city name [146](#)
- Destination address
– entering [146](#), [152](#)
- Destination entry via BMW Assist [151](#)

- Destination for navigation
 - entering by voice [152](#)
 - entering via map [151](#)
 - entry [146](#)
 - home address [149](#)
 - manual entry [146](#)
 - Destination guidance [155](#)
 - bypassing a route section [156](#)
 - changing specified route [155](#)
 - continuing [155](#)
 - starting [155](#)
 - voice instructions [157](#)
 - volume of voice instructions [157](#)
 - Digital clock [83](#)
 - Digital compass [122](#)
 - Digital radio, refer to HD Radio [171](#)
 - Dimensions [280](#)
 - Directional indicators, refer to Turn signals [72](#)
 - Direction instructions, refer to Voice instructions [157](#)
 - Directory for navigation, refer to Address book [148](#)
 - Display, refer to iDrive controls [20](#)
 - Displaying contact pictures [215](#)
 - Display lighting, refer to Instrument lighting [114](#)
 - Displays
 - on the Control Display [20](#)
 - Displays, refer to Instrument cluster [14](#)
 - Displays and controls [12](#)
 - Disposal
 - coolant [259](#)
 - remote control battery [41](#)
 - vehicle battery [271](#)
 - Distance remaining to service, refer to Service requirements [88](#)
 - Distance warning, refer to Park Distance Control PDC [96](#)
 - Door key, refer to Remote control with integrated key [32](#)
 - Door lock [36](#)
 - Doors, emergency operation [36](#)
 - DOT Quality Grades [250](#)
 - Draft-free ventilation [118](#)
 - Drinks holders, refer to Cupholders [125](#)
 - Drive mode [69](#)
 - Drive-off assistance, refer to Dynamic Stability Control DSC [97](#)
 - Drive-off assistant [100](#)
 - Driving dynamics control [70](#)
 - Driving lamps, refer to Parking lamps/low beams [110](#)
 - Driving notes [136](#)
 - Driving off on hills, refer to Drive-off assistant [100](#)
 - Driving stability control systems [97](#)
 - Driving through water [138](#)
 - Driving tips, refer to Driving notes [136](#)
 - Dry air, refer to Air conditioning [118](#)
 - DSC Dynamic Stability Control [97](#)
 - DTC Dynamic Traction Control [98](#)
 - indicator/warning lamp [98](#)
 - DVD
 - country codes [180](#)
 - settings [181](#)
 - video playback [180](#)
 - DVD menu [181](#)
 - DVD player, refer to CD player [178](#)
 - DVD video [180](#)
 - Dynamic Brake Control DBC [97](#)
 - Dynamic destination guidance [162](#)
 - Dynamic Stability Control DSC [97](#)
 - indicator/warning lamp [98](#)
 - Dynamic Traction Control DTC [98](#)
 - indicator/warning lamp [98](#)
- ## E
- EBV Electronic brake-force distribution [97](#)
 - Eject button, see buttons on the CD/DVD player [166](#)
 - Electrical defect
 - 7-gear Sport automatic transmission with double clutch [70](#)
 - Electrical malfunction
 - door lock [36](#)
 - driver's door [36](#)
 - fuel filler flap [232](#)
 - Electric seat adjustment [50](#)
 - Electric steering wheel lock
 - with Comfort Access [40](#)
 - Electronic brake-force distribution EBV [97](#)
 - Electronic oil level check [256](#)
 - Electronic Stability Program ESP, refer to Dynamic Stability Control DSC [97](#)
 - E-mail [218](#)
 - Emergency actuation, automatic transmission, refer to Overriding selector lever lock [67](#)
 - Emergency operation
 - fuel filler flap, manual release [232](#)
 - Emergency operation, refer to Manual operation
 - door lock [36](#)
 - Emergency release
 - trunk lid from inside [38](#)
 - Emergency Request [272](#)

- Emergency services, refer to
Roadside Assistance [273](#)
- Energy, saving
– saving fuel [136](#)
- Engine
– breaking in [136](#)
– overheated, refer to Coolant temperature [259](#)
– starting [63](#)
– starting, Comfort Access [40](#)
– switching off [64](#)
- Engine compartment [255](#)
- Engine coolant, refer to
Coolant [259](#)
- Engine oil
– adding [258](#)
– additives, refer to Approved engine oils [258](#)
– alternative oil types [258](#)
– approved engine oils [258](#)
– BMW Maintenance System [260](#)
– capacity [282](#)
– checking level [256](#)
– intervals between changes, refer to Service requirements [88](#)
- Engine starting, refer to
Starting the engine [63](#)
- Entering the postal code for navigation [147](#)
- Entry lamps, refer to Interior lamps [114](#)
- Entry map for destination [151](#)
- Equalizer, tone control [167](#)
- ESP Electronic Stability Program, refer to Dynamic Stability Control DSC [97](#)
- Exhaust system, refer to Hot exhaust system [138](#)
- Exterior mirrors [55](#)
– adjusting [55](#)
– automatic dimming feature [56](#)
– automatic heating [55](#)
– folding in and out [55](#)
- External audio device [125](#)
- External devices [189](#)
– random sequence [192](#)
- Eyes
– for tow-starting and towing away [275](#)
– for tying down loads [140](#)
- ## F
- Failure messages, refer to
Check Control [92](#)
- Failure of an electrical consumer [271](#)
- False alarm
– avoiding unintentional alarm [39](#)
– switching off an alarm [39](#)
- Fastening safety belts, refer to
Safety belts [54](#)
- Fastest route for navigation [155](#)
- Fast forward
– CD player [180](#)
- Fault messages, refer to
Check Control [92](#)
- Filter
– refer to Microfilter/activated-charcoal filter for automatic climate control [119](#)
- First aid pouch [273](#)
- Fixture for remote control, refer to Ignition lock [62](#)
- Flash when locking/unlocking [35](#)
- Flat tire
– run-flat tires [253](#)
– tire pressure monitor TPM [102](#)
- Flat Tire Monitor FTM [100](#)
– indicating a flat tire [101](#)
– indicator/warning lamp [101](#)
– initialization [100](#)
– snow chains [100](#), [254](#)
– system limits [100](#)
- Flat tires, refer to Tire condition [251](#)
- Fluid reservoir, refer to
Washer fluid reservoir [74](#)
- FM, waveband [169](#)
- Fog lamps [113](#)
– indicator lamp [15](#), [113](#)
- Folding up the floor panel [130](#)
- Footwell lamps, refer to
Interior lamps [114](#)
- For your own safety [5](#)
- Four-wheel drive, refer to
xDrive [99](#)
- Free memory capacity, music collection [188](#)
- Front airbags [107](#)
- FTM, refer to Flat Tire Monitor [100](#)
- Fuel [233](#)
– average consumption [85](#)
– gauge [84](#)
– high-quality brands [233](#)
– quality [233](#)
– specifications [233](#)
– tank contents, refer to Capacities [282](#)
- Fuel clock, refer to Fuel gauge [84](#)
- Fuel consumption indicator
– average fuel consumption [85](#)
- Fuel display, refer to Fuel gauge [84](#)
- Fuel filler flap [232](#)
– releasing in the event of electrical malfunction [232](#)
- Fuses [271](#)
- ## G
- Garage door opener, refer to
Integrated universal remote control [120](#)
- Gasoline
– refer to Average consumption [85](#)
- Gasoline, refer to Required fuel [233](#)

- Gasoline display, refer to Fuel gauge [84](#)
- Gas station recommendations [157](#)
- Gear indicator, automatic transmission with Steptronic [65](#)
- Gear indicator, refer to Displays in the instrument cluster [68](#)
- Gearshift lever [68](#)
- automatic transmission with Steptronic [65](#)
 - manual transmission [65](#)
- Gearshifts
- automatic transmission with Steptronic [65](#)
 - manual transmission [65](#)
- General driving notes [137](#)
- Glass roof, electric [43](#)
- convenient opening and closing [34](#)
 - convenient opening and closing with Comfort Access [40](#)
 - initializing [44](#)
 - opening, closing [43](#)
 - pinch protection system [43](#)
 - power failure [44](#)
 - remote control [34](#)
 - tilting [43](#)
- Glove compartment [124](#)
- GPS navigation, refer to Navigation system [144](#)
- Grills [115](#)
- Gross vehicle weight, refer to Weights [281](#)
- ## H
- Handbrake, refer to Parking brake [64](#)
- Hands-free system [16](#), [209](#)
- Hardtop label [128](#)
- Hardtop sticker [128](#)
- Hazard warning flashers [16](#)
- HDC Hill Descent Control [99](#)
- HD Radio [171](#)
- Head airbags [107](#)
- Headlamp control, automatic [110](#)
- Headlamp flasher [72](#)
- indicator lamp [13](#), [15](#)
- Head Light, refer to Adaptive Light Control [111](#)
- Head restraints [51](#)
- rear, removing [52](#)
 - sitting safely [48](#)
- Heated
- mirrors [55](#)
 - rear window [118](#)
 - seats [53](#)
 - steering wheel [57](#)
- Heating
- mirrors [55](#)
 - rear window [118](#)
 - seats [53](#)
 - steering wheel [57](#)
- Heating and ventilation, refer to Climate [115](#)
- Heavy loads, refer to Stowing cargo [140](#)
- Height, refer to Dimensions [280](#)
- Height adjustment
- seats [49](#)
 - steering wheel [56](#)
- High-beam Assistant [112](#)
- High beams [112](#)
- headlamp flasher [112](#)
 - indicator lamp [15](#)
- High beams and low beams, automatic, refer to High-beam Assistant [112](#)
- High-pressure washer [262](#)
- High water, refer to Driving through water [138](#)
- Highways, refer to Route criteria [155](#)
- Hill Descent Control HDC [99](#)
- Hills [139](#)
- Holders for cups [125](#)
- Homepage BMW [4](#)
- Hood [255](#)
- Hooks for shopping bags [129](#)
- Horn [12](#), [13](#)
- Hotel function, refer to Locking or unlocking separately [37](#)
- Hot exhaust system [138](#)
- Hydraulic brake assist, refer to Dynamic Brake Control [97](#)
- Hydroplaning [138](#)
- ## I
- IBOC, refer to HD radio [171](#)
- Ice warning, refer to Outside temperature warning [83](#)
- Identification marks
- run-flat tires [253](#)
 - tire coding [250](#)
- iDrive [20](#)
- adjusting brightness [95](#)
 - changing date and time [91](#)
 - changing language [95](#)
 - changing settings [95](#)
 - changing units of measure and display format [88](#)
 - controls [20](#)
 - menu guidance [21](#)
 - operating principle [20](#)
 - overview [20](#)
 - start menu [21](#)
 - status information [23](#)
- iDrive operating principle [20](#)
- Ignition [63](#)
- switched off [63](#)
 - switched on [63](#)
- Ignition key, refer to Remote control with integrated key [32](#)
- Ignition key position 1, refer to Radio readiness [62](#)
- Ignition key position 2, refer to Ignition on [63](#)
- Ignition lock [62](#)
- Imprint [2](#)

- Incoming call [205](#)
- Indicator and warning lamps [15](#)
- tire pressure monitor TPM [103](#)
- Inflation pressure, refer to Tire inflation pressure [235](#)
- Inflation pressure monitoring, refer to Tire Pressure Monitor TPM [102](#)
- Initializing
- after power failure [270](#)
 - compass, refer to Calibrating [123](#)
 - flat tire monitor FTM [100](#)
 - glass roof [44](#)
 - radio, refer to Storing stations [170](#)
 - refer to Setting the time and date [91](#)
- Installation location
- telephone [124](#)
- Instructions for navigation system, refer to Voice instructions [157](#)
- Instrument cluster [14](#)
- Instrument cluster, refer to Cockpit [12](#)
- Instrument combination, refer to Instrument cluster [14](#)
- Instrument lighting [114](#)
- Instrument panel, see instrument cluster [14](#)
- Integrated key [32](#)
- Integrated universal remote control [120](#)
- Interactive map [151](#)
- Interior lamps [114](#)
- remote control [34](#)
- Interior motion sensor [39](#)
- Interior rearview mirror [56](#)
- automatic dimming feature [56](#)
 - compass [122](#)
- Interlock, refer to Disengaging the remote control [65](#)
- Intermittent mode of the wipers [73](#)
- Intersection, entering, navigation [147](#)
- ## J
- Jacking points [270](#)
- Joystick, refer to iDrive [20](#)
- Jumpering, refer to Jump starting [274](#)
- Jump starting [274](#)
- ## K
- Key, refer to Integrated key/remote control [32](#)
- Keyless go, refer to Comfort Access [40](#)
- Keyless opening and closing, refer to Comfort Access [40](#)
- Key Memory, refer to Personal Profile [32](#)
- Keypad dialing [207](#)
- Kickdown [66](#)
- automatic transmission with Steptronic [66](#)
- Knock control [233](#)
- ## L
- Lamps
- automatic headlamp control [110](#)
 - parking lamps/low beams [110](#)
- Lamps and bulbs, replacing bulbs [266](#)
- Lap-and-shoulder belt, refer to Safety belts [54](#)
- Lashing eyes, refer to Securing cargo [140](#)
- Last destinations [149](#)
- LATCH child restraint fixing system [59](#)
- Launch Control [71](#)
- Leather care [263](#)
- LED Light-emitting diodes [267](#)
- Length, refer to Dimensions [280](#)
- License plate lamp, replacing bulb [269](#)
- Light
- high-beam Assistant [112](#)
- Light alloy wheels, care [264](#)
- Light-emitting diodes LED [267](#)
- Lighter [126](#)
- connecting electrical appliances [127](#)
- Lighting
- instruments [114](#)
 - lamps and bulbs [266](#)
 - vehicle, refer to Lamps [110](#)
- Light switch [110](#)
- Limit, refer to Speed limit [94](#)
- Load [140](#)
- Load securing equipment, refer to Securing cargo [140](#)
- Lock buttons, doors, refer to Locking [37](#)
- Locking
- adjusting confirmation signal [35](#)
 - from inside [37](#)
 - from outside [34](#)
 - without remote control, refer to Comfort Access [40](#)
- Locking and unlocking doors
- confirmation signals [35](#)
 - from inside [36](#)
 - from outside [33](#)
- Low beam control, refer to High-beam Assistant [112](#)
- Low-beam headlamps [110](#)
- automatic [110](#)
- Lower back support, refer to Lumbar support [50](#)
- Luggage rack, refer to Roof-mounted luggage rack [141](#)
- Lumbar support [50](#)

M

- M+S tires, refer to Winter tires [253](#)
- Maintenance, refer to Service and Warranty Information Booklet for US models or in the Warranty and Service Guide Booklet for Canadian models
- Maintenance system [260](#)
- Malfunction
- automatic transmission with Steptronic [67](#)
 - tires [101](#)
- Malfunction warnings, refer to Check Control [92](#)
- Managing music [187](#)
- Manually unlocking parking lock [70](#)
- Manual mode, automatic transmission with Steptronic [66](#)
- Manual operation
- door lock [36](#)
 - driver's door [36](#)
 - fuel filler flap [232](#)
 - parking lock [70](#)
 - parking lock, automatic transmission [67](#)
- Manual transmission [65](#)
- Map for navigation
- changing scale [158](#)
 - entering destination [151](#)
- Map view [157](#)
- Master key, refer to Remote control with integrated key [32](#)
- Maximum cooling [116](#)
- Maximum speed
- with winter tires [253](#)
- Measurements, refer to Dimensions [280](#)
- Memory, refer to Seat and mirror memory [53](#)
- MENU button [20](#)
- Menus, refer to iDrive [20](#)
- Messages [216](#)
- Messages from the Concierge service [217](#)
- Microfilter
- BMW Maintenance System [260](#)
 - for automatic climate control [119](#)
- Microfilter/activated-charcoal filter
- BMW Maintenance System [260](#)
- Microphone
- telephone [16](#)
 - voice commands [16](#)
- Mirror dimming feature [56](#)
- Mirrors [55](#)
- automatic curb monitor [56](#)
 - exterior mirrors [55](#)
 - heating [55](#)
 - interior rearview mirror [56](#)
 - memory, refer to Seat and mirror memory [53](#)
- Mirrors, folding in before entering a car wash [55](#)
- Mobile phone
- adjusting volume [205](#)
 - connecting, refer to Mobile phone, pairing [201](#)
 - installation location, refer to Center armrest [124](#)
 - operation [205](#)
 - pairing [201](#)
 - refer to separate Owner's Manual
 - suitable mobile phones [200](#)
 - unpairing [203](#)
 - what to do if.... [204](#)
- Mobile phone, refer to Telephone [200](#)
- Mobile phone, refer to the separate Owner's Manual
- Modifications, technical, refer to For your own safety [5](#)
- Monitor, refer to iDrive controls [20](#)
- Monitoring system for tire pressures, refer to Flat Tire Monitor [100](#)
- Multi-channel playback [167](#)
- Multifunctional steering wheel, refer to Buttons on the steering wheel [13](#)
- Multifunction switch
- refer to Turn signals/headlamp flasher [72](#)
 - refer to Wiper system [72](#)
- Multimedia screen, refer to iDrive [20](#)
- Music collection [184](#)
- random sequence [187](#)
 - restoring [188](#)
- Music interface for smartphones [190](#)
- Music search [185](#)
- My Info [217](#)

N

- Navigation
- starting destination guidance after entering a destination [148](#)
 - storing current position [148](#)
 - voice activation [152](#)
- Navigation announcements, refer to Switching voice instructions on/off [157](#)
- Navigation data [144](#)

Navigation system **144**
– address book **148**
– bypassing a route section **156**
– continuing destination guidance **155**
– destination entry **146**
– dynamic destination guidance **162**
– entering a destination by voice **152**
– entering a destination manually **146**
– frequently asked questions **163**
– gas station recommendations **157**
– planning a trip **153**
– route list **156**
– selecting destination via map **151**
– selecting route criteria **155**
– special destinations **149**
– starting destination guidance **155**
– terminating destination guidance **155**
– traffic bulletins **159**
– voice instructions **157**
– volume adjustment **157**
Neck support, refer to Head restraints **51**
Nets, refer to Storage compartments **125**
Neutral **69**
Neutral cleaners, care **264**
New tires **252**
Next Service indicator, refer to Condition Based Service CBS **260**
North-facing map **157**
Notes **220**
Nozzles **115**
Nylon rope, refer to Tow rope **276**

O

OBD socket, refer to Socket for Onboard Diagnosis **261**
Octane ratings, refer to Fuel specifications **233**
Odometer **83**
Office **213**
– current office **213**
– what to do if.... **221**
Oil, refer to Engine oil **256**
Oil consumption **256**
Oil level **256**
Old batteries, refer to Disposal **271**
Onboard vehicle tool kit **266**
Opening and closing
– comfort access **40**
– from inside **36**
– from outside **33**
– using the door lock **36**
– using the remote control **33**
Opening and closing retractable hardtop **44**
Options, selecting for navigation **155**
Orientation menu, refer to Start menu **21**
Outlets
– refer to Ventilation **118**
Outside-air mode
– automatic climate control **117**
Outside temperature display **83**
– changing unit of measure **88**
– in computer **88**
Outside temperature warning **83**
Overheated engine, refer to Coolant temperature **259**
Overriding selector lever lock **67**
Overview
– radio operation **166**

P

Paintwork care **263**
Park assistant, refer to Park Distance Control **96**
Park Distance Control PDC **96**
Parked car ventilation **119**
– preselecting switch-on times **119**
– switching on and off directly **119**
Parking
– vehicle **64**
Parking aid, refer to Park Distance Control PDC **96**
Parking brake **64**
– indicator lamp **64**
Parking lamps **110**
– replacing bulbs **267**
Parking lamps/low beams **110**
Parts and accessories, refer to Vehicle equipment **5**
Passenger side mirror tilt function **56**
Pathway lighting **111**
Personal information, refer to Office **213**
Personal Profile **32**
Phone numbers
– dialing **206**
Pinch protection system
– glass roof, electric **43**
– windows **42**
Playing music **185**
Pollen
– refer to Microfilter/activated-charcoal filter for automatic climate control **119**
Power failure **270**
Power windows **42**
Power windows, refer to Windows **41**
Pressure, tires **235**
Pressure monitoring, tires **100**
– flat Tire Monitor **100**

- Pressure monitoring of tires, refer to Tire Pressure Monitor TPM [102](#)
- Programmable buttons on the steering wheel [13](#)
- Programmable memory keys [25](#)
- Protection function, refer to Pinch protection system
 - glass roof, electric [43](#)
 - windows [42](#)
- Providing medical assistance, refer to First aid pouch [273](#)
- Puncture
 - flat Tire Monitor [100](#)
- R**
- Radio
 - controls [166](#)
 - HD radio [171](#)
 - satellite radio [173](#)
 - selecting waveband [169](#)
 - storing stations [170](#)
 - switching on/off [166](#)
 - tone control [167](#)
 - volume [166](#)
- Radio position, refer to Radio readiness [62](#)
- Radio readiness [62](#)
 - switched off [63](#)
 - switched on [62](#)
- Radio-remote key, refer to Remote control with integrated key [32](#)
- Rain sensor [73](#)
- Random sequence
 - CD player [179](#)
 - external devices [192](#)
 - music collection [187](#)
- Reading aloud [221](#)
- Reading lamps [114](#)
- Rear lamps, refer to Tail lamps [268](#)
- Rear seats
 - adjusting head restraints [52](#)
 - folding down backrests [127](#)
- Rear ventilation [118](#)
- Rearview mirror, refer to Mirrors [55](#)
- Rear window defroster [118](#)
- Rear window roller blind, refer to Roller sunblinds [124](#)
- Reception
 - quality [170](#)
 - radio station [170](#)
- Recirculated air mode [117](#)
- Recirculation of air, refer to Recirculated air mode [117](#)
- Reclining seat, refer to Backrest [49](#)
- Redialing [208](#)
- Refueling [232](#)
- Releasing
 - hood [256](#)
- Remaining distance, refer to Cruising range [85](#)
- Reminders [220](#)
- Remote control [32](#)
 - battery renewal [41](#)
 - comfort access [40](#)
 - garage door opener [120](#)
 - malfunction [35, 41](#)
 - removing from the ignition lock [62](#)
 - service data [260](#)
 - trunk lid [34](#)
- Replacement fuses, refer to Fuses [271](#)
- Replacement remote control [32](#)
- Replacing bulbs, refer to Lamps and bulbs [266](#)
- Replacing tires [252](#)
- Replacing tires, refer to New wheels and tires [252](#)
- Reporting safety defects [7](#)
- Reserve warning, refer to Fuel gauge [84](#)
- Reset, refer to Resetting tone settings [168](#)
- Restraint systems
 - for children [58](#)
 - refer to Safety belts [54](#)
- Retractable hardtop [44](#)
 - care, refer to Caring for your vehicle brochure
 - convenient opening and closing [34](#)
 - remote control [34](#)
- Reverse
 - CD player [180](#)
- Reverse gear [69](#)
 - automatic transmission with Steptronic [66](#)
 - manual transmission [65](#)
- Rim cleaner, care [264](#)
- Road map [157](#)
- Roadside
 - Assistance [225, 273](#)
- Roadside parking lamps [112](#)
 - replacing bulbs [267](#)
- Roadworthiness test, refer to Service requirements [88](#)
- Roller sunblinds [124](#)
- Rollover protection system, Convertible [109](#)
 - resetting [109](#)
- Roof load capacity [281](#)
- Roof-mounted luggage rack [141](#)
- Rope, refer to Tow-starting, towing away [276](#)
- Rotary/pushbutton, refer to iDrive [20](#)
- Route [155, 156](#)
 - bypassing sections [156](#)
 - changing [155, 156](#)
 - changing criteria [155](#)
 - displaying streets or towns/cities [156](#)
 - map view [157](#)
 - selecting [155](#)

Route instructions, refer to
Destination guidance
through voice
instructions **157**

Route map, refer to Map
view **157**

Route section, changing **156**

Route selection **155**

RSC Runflat System
Component, refer to Run-
flat tires **253**

Runflat System Component
RSC, refer to Run-flat
tires **253**

Run-flat tires **253**

- continuing driving with a
damaged tire **101**
- flat tire **101**
- flat tire monitor **101**
- inflation pressure **235**
- new tires **252**
- tire replacement **252**
- winter tires **253**

Runflat tyres, refer to Run-flat
tires **253**

S

Safety-belt height
adjustment **54**

Safety belts **54**

- belt hand-over **54**
- damage **54**
- indicator/warning lamp **54**
- reminder **54**
- sitting safely **48**

Safety systems

- airbags **107**
- antilock brake system
ABS **97**
- brake system **97**
- driving stability control **97**
- dynamic stability control
DSC **97**
- rollover protection system,
Convertible **109**
- safety belts **54**

Safety tires, refer to Run-flat
tires **253**

Satellite radio **173**

- activating or deactivating
channels **173**
- favorites **176**
- selecting channels **174**
- storing channels **174**
- time shift **175**
- traffic jump **177**

Saving fuel **136**

Screen, refer to iDrive
controls **20**

Screw thread for tow
fitting **275**

SDARS, refer to satellite
radio **173**

Seat adjustment

- electric **50**
- mechanical **49**

Seat and mirror memory **53**

Seat belt reminder, refer to
"Fasten safety belts"
reminder **54**

Seat heating **53**

Seats **49**

- adjusting electrically **50**
- adjusting the seats **49**
- heating **53**
- memory, refer to Seat and
mirror memory **53**
- saving a setting, refer to Seat
and mirror memory **53**
- sitting safely **48**

Securing cargo **131, 132**

Securing the vehicle

- from inside **36**
- from outside **33**

Selecting a station

- radio **169**

Selecting distance for Active
Cruise Control **78**

Selecting new scale for
navigation **158**

Selector lever

- automatic transmission with
Steptronic **65**

Selector lever lock, refer to
Changing selector lever
positions, shiftlock **65**

Selector lever positions **68**

- automatic transmission with
Steptronic **65**

Service, refer to Roadside
Assistance **273**

Service car, refer to Roadside
Assistance **273**

Service data in the remote
control **260**

Service Interval Display, refer
to Condition Based Service
CBS **260**

Service Request **227**

Service requirements **88**

Service status **228**

Settings

- changing settings on the
Control Display **95**
- clock, 12h/24h format **91**
- DVD **181**
- language **95**

Settings and information **87**

Settings for the map view **158**

Setting times, refer to
Preselecting switch-on
times **119**

Setting tone during audio
operation, refer to Tone
control **167**

Shifting **69**

- 7-gear Sport automatic
transmission with double
clutch **69**

Shifting gears

- automatic transmission with
Steptronic **66**
- manual transmission **65**

Shift into a drive position, refer
to selector lever
positions **68**

Shiftlock

- automatic transmission,
refer to Changing selector
lever positions **65**

- Shift paddles on the steering wheel [70](#)
- Short commands for the voice activation system [283](#)
- Short route in navigation, refer to [Selecting route](#) [155](#)
- Side airbags [107](#)
- Side windows, refer to [Windows](#) [41](#)
- Signal horn, refer to [Horn](#) [12, 13](#)
- Sitting safely [48](#)
- with airbags [48](#)
 - with head restraint [48](#)
 - with safety belts [48](#)
- Ski bag [130](#)
- Ski bag for Convertible, refer to [Through-loading opening with integrated transport bag](#) [131](#)
- Sliding/tilt sunroof, refer to [Glass roof, electric](#) [43](#)
- Slot for remote control [62](#)
- Smokers' package, refer to [Ashtray](#) [126](#)
- Snap-in adapter [200](#)
- inserting/removing [211](#)
- Snap-in adapter, refer to [Center armrest storage compartment](#) [124](#)
- Socket, Onboard Diagnosis OBD [261](#)
- Socket, refer to [Connecting electrical appliances](#) [127](#)
- Software update [196](#)
- SOS, refer to [Sending an Emergency Request](#) [272](#)
- Spare fuses [271](#)
- Special destinations [149](#)
- Special destinations, displaying [151](#)
- Special oils, refer to [Approved engine oils](#) [258](#)
- Specified engine oils, refer to [Approved engine oils](#) [258](#)
- Speed
- run-flat tires [101](#)
 - with winter tires [253](#)
- Speed limit [94](#)
- Speed limit warning, refer to [Speed limit](#) [94](#)
- Speedo, refer to [Speedometer](#) [14](#)
- Speedometer [14](#)
- Speed Volume [168](#)
- Split screen content, refer to [Selecting the display for the split screen content](#) [24](#)
- Sport automatic transmission with double clutch [67](#)
- driving dynamics control [70](#)
 - kickdown [69](#)
 - launch control [71](#)
 - manually unlocking parking lock [70](#)
 - neutral [69](#)
 - reverse gear [69](#)
- Sport program with 7-gear Sport automatic transmission with double clutch [69](#)
- Spray nozzles, refer to [Cleaning windshield and headlamps](#) [73](#)
- Stability control, refer to [Driving stability control systems](#) [97](#)
- Start/Stop button [62](#)
- starting the engine [63](#)
 - switching off the engine [64](#)
- Starting, refer to [Starting the engine](#) [63](#)
- Starting assistance, refer to [Jump starting](#) [274](#)
- Starting difficulties
- jump starting [274](#)
- Starting the engine
- start/stop button [62](#)
- Start menu [21](#)
- State/province, for navigation [146](#)
- Status information on the Control Display [23](#)
- Status of this Owner's Manual at time of printing [5](#)
- Steam jet [262](#)
- Steering wheel [56](#)
- adjustment [56](#)
 - buttons on steering wheel [13](#)
 - heating [57](#)
 - lock [62](#)
 - locking with Comfort Access [40](#)
 - shift paddles [70](#)
- Steering wheel buttons, refer to [Shift paddles](#) [70](#)
- Steering with variable ratio, refer to [Active steering](#) [105](#)
- Steptronic, refer to [Automatic transmission with Steptronic](#) [65](#)
- Storage [265](#)
- Storage compartments [125](#)
- Storage nets [129](#)
- Stored trip, calling up [154](#)
- Storing a destination in the address book [148](#)
- Storing music [184](#)
- Storing seat positions, refer to [Seat and mirror memory](#) [53](#)
- Storing tires [253](#)
- Stowage, refer to [Storage compartments](#) [125](#)
- Street, entering, navigation [147](#)
- Suitable mobile phones [200](#)
- Summer tires, refer to [Wheels and tires](#) [235](#)
- Surround [167](#)
- SVCD [180](#)
- SW, waveband [169](#)
- Switches, refer to [Cockpit](#) [12](#)

Switching off
– engine [64](#)
Switching off the engine
– start/stop button [62](#)
Switching on
– audio [166](#)
– CD player [166](#)
– radio [166](#)
Switching the air conditioning
on and off [118](#)
Switching the entertainment
audio output on/off [166](#)
Switch-on times of parked car
ventilation, preselecting [119](#)
Symbols [4](#)

T

Tachometer [84](#)
Tailgate, refer to Trunk lid [37](#)
Tail lamp
– replacing bulb [269](#)
Tail lamp, refer to Tail
lamps [268](#)
Tail lamps [268](#)
– replacing bulb [268](#), [269](#)
Tank contents, refer to
Capacities [282](#)
Tasks [219](#)
Technical data [280](#)
– dimensions [280](#)
Technical modifications, refer
to For your own safety [5](#)
Telephone [200](#)
– hands-free system [209](#)
– installation location, refer to
Center armrest [124](#)
– phone book [207](#)
– received calls [208](#)
– redialing [208](#)
– refer to separate Owner's
Manual
– voice commands [209](#)

TeleService [225](#)
Teleservice Diagnosis [226](#)
Temperature
– automatic climate
control [116](#)
– changing unit of measure [88](#)
– coolant, refer to Coolant
temperature [259](#)
Temperature display
– outside temperature [83](#)
– outside temperature
warning [83](#)
– setting the units [88](#)
Tempomat, refer to Cruise
control [74](#)
Tensioning straps, refer to
Securing cargo [140](#)
Text message [217](#)
Third brake lamp, refer to
Center brake lamp [269](#)
Through-loading opening with
integrated transport
bag [131](#)
Through-loading system [127](#)
Tilt alarm sensor [39](#)
Tilt function, passenger side
mirror [56](#)
Timer, refer to Preselecting
switch-on times [119](#)
Tire inflation pressure [235](#)
– loss [101](#), [102](#)
Tire pressure monitoring,
refer to Flat Tire
Monitor [100](#)
Tire Pressure Monitor
TPM [102](#)
– resetting the system [103](#)
– system limitations [102](#)
– warning lamp [103](#)
Tire puncture, refer to Flat Tire
Monitor [101](#)
Tire Quality Grading [250](#)

Tires
– age [250](#), [252](#)
– air loss [103](#)
– breaking in [136](#)
– changing, refer to Changing
wheels [269](#)
– condition [251](#)
– damage [251](#)
– inflation pressure [235](#)
– labels [250](#)
– minimum tread depth [251](#)
– new wheels and tires [252](#)
– pressure monitoring, refer to
Flat Tire Monitor [100](#)
– pressure monitoring, refer to
Tire Pressure Monitor
TPM [102](#)
– puncture [101](#)
– replacing [252](#)
– run-flat tires [253](#)
– size [250](#)
– storage [253](#)
– tread depth [251](#)
– wear indicators, refer to
Minimum tread depth [251](#)
– wheel/tire combination, refer
to Correct wheels and
tires [252](#)
– winter tires [253](#)
TMC station, refer to Traffic
bulletins [159](#)
Tone
– control [167](#)
– middle setting [168](#)
Tools, refer to Onboard
vehicle tool kit [266](#)
Top, refer to Retractable
hardtop [44](#)
Top 50 in music
collection [186](#)
Tow bar [276](#)
Tow fitting [275](#)
– screw thread [275](#)

- Tow fittings for tow-starting and towing away [275](#)
 - Towing [275](#)
 - car with automatic transmission [275](#)
 - methods [276](#)
 - with 7-gear Sport automatic transmission with double clutch [276](#)
 - Towing and tow-starting [275](#)
 - Town/city, for navigation [146](#)
 - Tow rope [276](#)
 - Tow-starting [275](#), [277](#)
 - TPM, refer to Tire Pressure Monitor [102](#)
 - Track
 - selecting on CD [178](#)
 - Traction control, refer to Dynamic Stability Control DSC [97](#)
 - Traffic bulletins
 - categories [161](#)
 - Traffic bulletins, filtering [161](#)
 - Traffic bulletins for navigation [159](#)
 - during destination guidance [161](#)
 - Traffic bulletins in navigation
 - screen display in the map view [160](#)
 - Traffic congestion
 - displaying traffic bulletins [159](#)
 - refer to Route, bypassing segments [156](#)
 - Transmission
 - 7-gear Sport automatic transmission with double clutch [67](#)
 - automatic transmission with Steptronic [65](#)
 - idle position [69](#)
 - launch control [71](#)
 - manually unlocking parking lock [70](#)
 - manual transmission [65](#)
 - overriding selector lever lock for automatic transmission with Steptronic [67](#)
 - reverse gear [69](#)
 - Transmission interlock
 - refer to Changing selector lever position [65](#)
 - refer to P Park [66](#)
 - Transporting children safely [58](#)
 - Transport securing devices, refer to Securing cargo [140](#)
 - Tread depth, refer to Minimum tire tread [251](#)
 - Trip, deleting [154](#)
 - Trip, storing [154](#)
 - Trip computer, refer to Displays on the Control Display [85](#)
 - Trip-distance counter, refer to Trip odometer [83](#)
 - Triple turn signal activation [72](#)
 - Trip odometer [83](#)
 - Trips, changing [154](#)
 - Trunk
 - capacity [281](#)
 - comfort access [41](#)
 - folding up the floor panel [130](#)
 - lamp, refer to Interior lamps [114](#)
 - opening from inside [37](#)
 - opening from outside [37](#)
 - Trunk lid [37](#)
 - comfort access [41](#)
 - emergency release [38](#)
 - locking or unlocking separately [37](#)
 - opening from inside [37](#)
 - opening from outside [37](#)
 - remote control [34](#)
 - Turning circle, refer to Dimensions [280](#)
 - Turn signal [72](#)
 - Turn signal indicators
 - indicator/warning lamp [14](#)
 - Turn signals
 - triple turn signal [72](#)
 - Tying down loads, refer to Cargo loading [140](#)
- ## U
- Uniform Tire Quality Grading/UTQR [250](#)
 - Units
 - average fuel consumption [88](#)
 - Units of measure
 - temperature [88](#)
 - Universal garage door opener, refer to Integrated universal remote control [120](#)
 - Unlatching, refer to Unlocking [40](#)
 - Unlocking
 - from inside [37](#)
 - from outside [34](#)
 - setting unlocking characteristics [34](#)
 - trunk lid [41](#)
 - without remote control, refer to Comfort Access [40](#)
 - Updating software [196](#)
 - Updating the navigation data [144](#)
 - USB audio interface [190](#)
 - USB interface [124](#)
 - Using contact data [220](#)

V

Variable light distribution,
refer to Adaptive Light
Control **111**

VCD **180**

Vehicle

- battery **270**
- breaking in **136**
- cargo loading **139**
- identification number, refer
to Engine compartment **255**
- measurements, refer to
Dimensions **280**
- parking **64**
- weight **281**

Vehicle equipment **5**

Vehicle jack **270**

Vehicle storage **265**

Ventilation **118**

- draft-free **118**
- in the rear **118**

Ventilation, refer to
Climate **115**

Ventilation while at a
standstill **119**

Vents, refer to Ventilation **118**

Video menu **180**

Video playback **180**

Voice, refer to Destination
guidance through voice
instructions **157**

Voice commands

- overview **27**
- short commands **283**
- telephone **209**

Voice instructions from
navigation system **157**

- repeating **157**
- switching on/off **157**
- volume **157**

Voice phone book **210**

Volume **166**

- audio sources **166**
- fuel tank, refer to
Capacities **282**
- mobile phone **205**
- voice instructions **157**

Volume compensation, tone
control **168**

W

Warning and indicator
lamps **15**

Warning messages, refer to
Check Control **92**

Warning triangle **273**

Washer fluid **74**

Washer fluid reservoir **74**

Waste tray, refer to
Ashtray **126**

Water on roads, refer to
Driving through water **138**

Water penetration **262**

Waveband on radio **169**

Wear indicators in tires, refer
to Minimum tread depth **251**

Weights **281**

Welcome lamps **111**

Wheel/tire combination, refer
to Correct wheels and
tires **252**

Wheelbase, refer to
Dimensions **280**

Wheels, new **252**

Wheels and tires **235**

Width, refer to
Dimensions **280**

Wind deflector **45**

Windows **41**

- convenient opening and
closing **34**
- convenient opening and
closing with Comfort
Access **40**
- opening, closing **42**
- pinch protection system **42**

Windows, indicator on Control
Display **20**

Windshield

- cleaning **73**

Windshield wash **72**

- filling capacity, reservoir **282**
- nozzles **74**
- reservoir for washer fluid **74**
- washer fluid **74**

Windshield wiper blades,
changing **266**

Windshield wipers, refer to
Wiper system **72**

Winter tires **253**

- setting speed limit **94**
- storage **253**

Wiper blade replacement **266**

Wiper system **72**

Work in the engine
compartment **255**

Wrench/screwdriver, refer to
Onboard vehicle tool kit **266**

X

xDrive **99**

Xenon lamps

- replacing bulb **267**

Y

Your individual vehicle

- settings, refer to Personal
Profile **32**

More about BMW



The Ultimate
Driving Machine

bmwusa.com

01 40 2 911 406 ue iDrive

